

PTVSxxxS1UR

Surface mount transient voltage suppressor power 200 watts

Stand-Off Voltage : 5.0V~220V

FEATURES

- For surface mounted applications in order to optimize board space.
- Low profile package
- Glass passivated junction
- Low inductance
- Plastic package has Underwriters Laboratory Flammability

MECHANICAL DATA

- Case: SOD-123FL
- Terminals: Solderable per MIL-STD-750, Method 2026
- Approx. Weight:15mg 0.00048oz

Maximum Ratings and Electrical characteristics

Ratings at 25 °C ambient temperature unless otherwise specified.

Parameter	Symbol	Value	Unit
Peak Pulse Power Dissipation on TA=25°C (Note 1,2,5, Fig1)	P_{PPM}	200	W
Peak Forward Surge Current (Note 3)	I_{FSM} (UNI)	20	A
Peak Pulse Current on 10/1000 us waveform (Note 1) Fig 2	I_{PPM}	see Table 1	A
Steady State Power Dissipation (Note 4)	$P_{M(AV)}$	1	W
Operating Junction and Storage Range	T_J, T_{STG}	-55 to +150	°C
Typical Thermal Resistance	$R_{\theta JA}$	180	°C

NOTES

1. Non-repetitive current pulse per Fig 3 and derated above $T_A=25^\circ\text{C}$ per Fig 2
2. Mounted on 5mm² copper pads to each terminal
3. 8.3ms single half sinewave, or equivalent square wave duty cycle=4 pulses per minutes maximum
4. lead temperature at $T_L=75^\circ\text{C}$
5. Peak pulse powe. waveform is $t_p=10/1000\mu\text{s}$
6. A transient suppressor is selected according to the working peak reverse voltage(V_{RWM}), Which Should be equal to or greater than the DC or continuous peak operating voltage level

PINNING

PIN	DESCRIPTION
1	Cathode
2	Anode

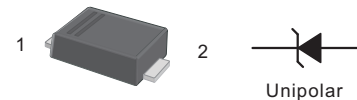

Top View
Simplified outline sSOD-123FL and symbol

PTVSxxxS1UR

Characteristics at Ta = 25°C

Type	Marking	V _{RWM}	Breakdown Voltage		Test Current	Reverse Leakage	Max. Clamp Voltage	Peak Pulse Current
			V _{BR} @ I _T		I _T	I _R @ V _{RWM}	V _C @ I _{PP}	I _{PP}
			Min	Max				
Uni	Uni	V	V	V	mA	μA	V	A
PTVS5V0S1UR	AE	5	6.4	7	10	200	9.2	21.7
PTVS6V0S1UR	AG	6	6.67	7.37	10	100	10.3	19.4
PTVS6V5S1UR	AK	6.5	7.22	7.98	10	75	11.2	17.9
PTVS7V0S1UR	AM	7	7.78	8.6	10	50	12	16.7
PTVS7V5S1UR	AP	7.5	8.33	9.21	1	50	12.9	15.5
PTVS8V0S1UR	AR	8	8.89	9.83	1	25	13.6	14.7
PTVS8V5S1UR	AT	8.5	9.44	10.4	1	10	14.4	13.9
PTVS9V0S1UR	AV	9	10	11.1	1	5	15.4	13
PTVS10V5S1UR	AX	10	11.1	12.3	1	2.5	17	11.8
PTVS11V5S1UR	AZ	11	12.2	13.5	1	2.5	18.2	11
PTVS12V5S1UR	BE	12	13.3	14.7	1	2.5	19.9	10.1
PTVS13V5S1UR	BG	13	14.4	15.9	1	1	21.5	9.3
PTVS14V5S1UR	BK	14	15.6	17.2	1	1	23.2	8.6
PTVS15V5S1UR	BM	15	16.7	18.5	1	1	24.4	8.2
PTVS16V5S1UR	BP	16	17.8	19.7	1	1	26	7.7
PTVS17V5S1UR	BR	17	18.9	20.9	1	1	27.6	7.2
PTVS18V5S1UR	BT	18	20	22.1	1	1	29.2	6.8
PTVS20V5S1UR	BV	20	22.2	24.5	1	1	32.4	6.2
PTVS22V5S1UR	BX	22	24.4	26.9	1	1	35.5	5.6
PTVS24V5S1UR	BZ	24	26.7	29.5	1	1	38.9	5.1
PTVS26V5S1UR	CE	26	28.9	31.9	1	1	42.1	4.8
PTVS28V5S1UR	CG	28	31.1	34.4	1	1	45.4	4.4
PTVS30V5S1UR	CK	30	33.3	36.8	1	1	48.4	4.1
PTVS33V5S1UR	CM	33	36.7	40.6	1	1	53.3	3.8
PTVS36V5S1UR	CP	36	40	44.2	1	1	58.1	3.4
PTVS40V5S1UR	CR	40	44.4	49.1	1	1	64.5	3.1
PTVS43V5S1UR	CT	43	47.8	52.8	1	1	69.4	2.9
PTVS45V5S1UR	CV	45	50	55.3	1	1	72.7	2.8
PTVS48V5S1UR	CX	48	53.3	58.9	1	1	77.4	2.6
PTVS51V5S1UR	CZ	51	56.7	62.7	1	1	82.4	2.4
PTVS54V5S1UR	DE	54	60	66.3	1	1	87.1	2.3
PTVS58V5S1UR	DG	58	64.4	71.2	1	1	93.6	2.1
PTVS60V5S1UR	DK	60	66.7	73.7	1	1	96.8	1.8
PTVS64V5S1UR	DM	64	71.1	78.6	1	1	103	1.7
PTVS70V5S1UR	DP	70	77.8	86	1	1	113	1.5
PTVS75V5S1UR	DR	75	83.3	92.1	1	1	121	1.4
PTVS78V5S1UR	DT	78	86.7	95.8	1	1	126	1.4
PTVS85V5S1UR	DV	85	94.4	104	1	1	137	1.3
PTVS90V5S1UR	DX	90	100	111	1	1	146	1.2
PTVS100V5S1UR	DZ	100	111	123	1	1	162	1.1
PTVS110V5S1UR	EE	110	122	135	1	1	177	1
PTVS120V5S1UR	EG	120	133	147	1	1	193	0.9
PTVS130V5S1UR	EK	130	144	159	1	1	209	0.8
PTVS150V5S1UR	EM	150	167	185	1	1	243	0.7
PTVS160V5S1UR	EP	160	178	197	1	1	259	0.7
PTVS170V5S1UR	ER	170	189	209	1	1	275	0.6
PTVS180V5S1UR	ET	180	201	222	1	1	292	0.5
PTVS200V5S1UR	EX	200	224	247	1	1	324	0.5
PTVS220V5S1UR	E22	220	246	272	1	1	356	0.5

Fig.1 Peak Pulse Power Rating Curve

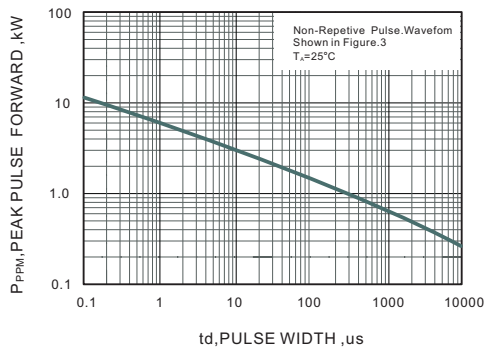

Fig.2 Forward Current Derating Curve

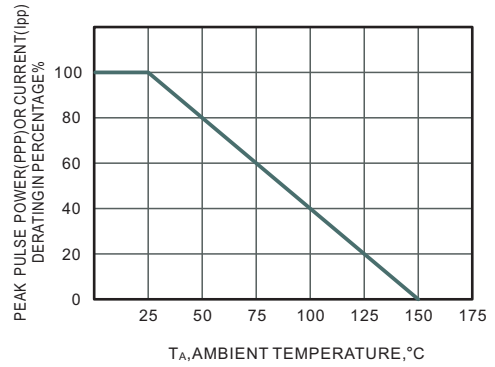

Fig.3 Pulse Waveform

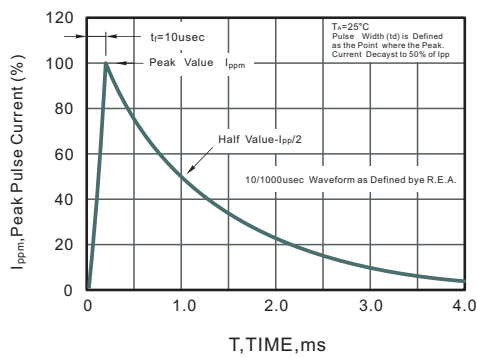
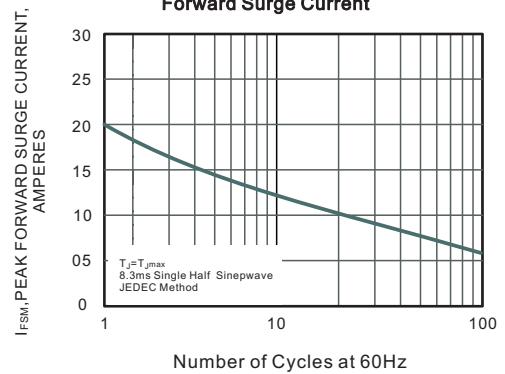

Fig.4 Maximum Non-Repetitive Peak Forward Surge Current



PTVSxxxS1UR

PACKAGE OUTLINE

Plastic surface mounted package; 2 leads

SOD-123FL

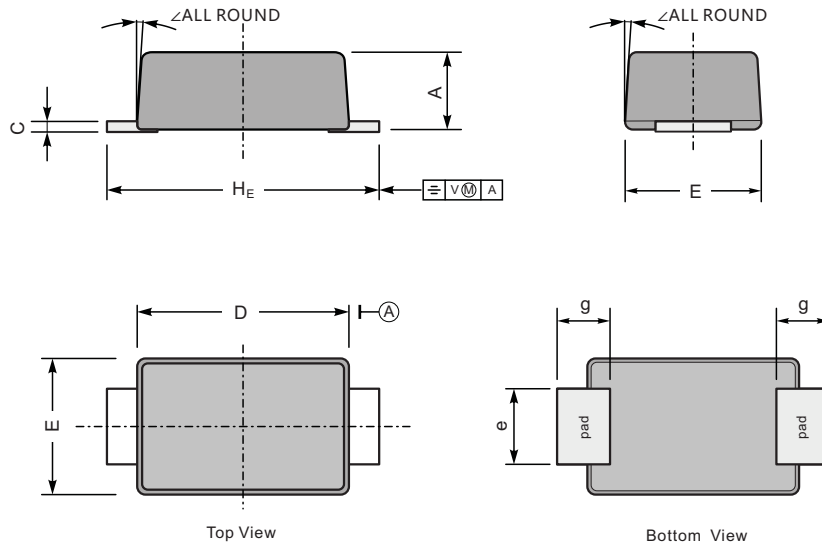

UNIT		A	C	D	E	e	g	HE	∠
mm	max	1.1	0.20	2.9	1.9	1.1	0.9	3.8	7°
	min	0.9	0.12	2.6	1.7	0.8	0.7	3.5	
mil	max	43	7.9	114	75	43	35	150	
	min	35	4.7	102	67	31	28	138	

The recommended mounting pad size

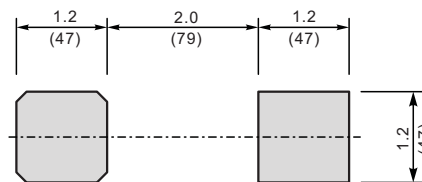

Unit: $\frac{\text{mm}}{\text{(mil)}}$

X-ON Electronics

Largest Supplier of Electrical and Electronic Components

Click to view similar products for [ESD Suppressors / TVS Diodes](#) category:

Click to view products by [Yongyutai Electronics](#) manufacturer:

Other Similar products are found below :

[60KS200C](#) [D18V0L1B2LP-7B](#) [D5V0F4U5P5-7](#) [NTE4902](#) [P4KE27CA](#) [P6KE11CA](#) [P6KE8.2A](#) [SA60CA](#) [SA64CA](#) [SMBJ12CATR](#)
[SMBJ33CATR](#) [SMBJ6.5A](#) [SMBJ8.0A](#) [ESD101-B1-02ELS](#) [E6327](#) [ESD112-B1-02EL](#) [E6327](#) [ESD7451N2T5G](#) [19180-510](#) [CPDT-5V0USP-](#)
[HF](#) [3.0SMCJ33CA-F](#) [3.0SMCJ36A-F](#) [HSPC16701B02TP](#) [JANTX1N6126A](#) [D3V3Q1B2DLP3-7](#) [D55V0M1B2WS-7](#) [SCM1293A-04SO](#)
[ESD200-B1-CSP0201](#) [E6327](#) [SM12-7](#) [CEN955 W/DATA](#) [VESD12A1A-HD1-GS08](#) [CPDQC5V0-HF](#) [D1213A-01LP4-7B](#) [ESD101-B1-02EL](#)
[E6327](#) [AOZ8808DI-03](#) [5KP15A](#) [5KP48A](#) [5KP90A](#) [ESD3V3D7-TP](#) [15KPA36A-LF](#) [P4KE56CA](#) [P4KE68A](#) [P4KE91CATR](#) [P6KE120A](#)
[P6KE13CA](#) [P6KE43CA](#) [P6KE6.8CA](#) [P6KE8.2](#) [P6SMBJ20CA](#) [JANTX1N6072A](#) [SR2835ESKG](#) [SA90CA](#)