

## General Description

The AD8541 (single), AD8542 (dual) and AD8544 (quad) are low voltage micro power CMOS voltage feedback operational amplifiers. With an excellent bandwidth of 1.1MHz, a slew rate of 0.8V/µs, and a quiescent current of 85µA per amplifier at 5V, the AD854xA family can be designed into a wide range of applications.

The AD854x op-amps are specifically designed for general-purpose applications with optimal performance. They have a wide input common-mode voltage range and output voltage swing, and the maximum input offset voltage are 3.5mV. These parts provide rail-to-rail output swing into heavy loads. The AD854x family is specified for single or dual power supplies of +2.3V to +5.5V. All models are specified over the extended industrial temperature range of -40°C to +125°C.

The AD8541 is available in 5-lead SC70 and SOT-23, and 8-lead SOP packages. The AD8542 is available in 8-lead MSOP and SOP packages. The AD8544 is available in 14-lead TSSOP and SOP packages.

## Features

- High Gains of >100 dB for Active Filters and Gain Stages
- Low Offset Voltage: 3.5 mV Maximum with 2 µV/°C Low Drift
- Gain-Bandwidth Product: 1.1 MHz
- High Slew Rate: 0.8 V/µs
- Low Power: 85 µA per Amplifier Supply Current
- Settling Time to 0.1% with 2V Step: 4.5 µs
- Unit Gain Stable
- Very Low Input Bias Current: 1 pA
- Rail-to-Rail Input and Output
  - Input Voltage Range: -0.2V to +5.2V at 5V Supply
- Operating Power Supply: +2.3V to +5.5V
- Operating Temperature Range: -40°C to +125°C
- ESD Rating: HBM-4kV, CDM-2kV

## Applications

- Smoke/Gas/Environment Sensors
- Audio Outputs
- Active Filters&ASIC Input or Output Amplifier
- Sensor Interfaces & Portable Equipment

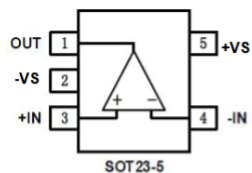

**8541A**  
SC70-5/SOT23-5

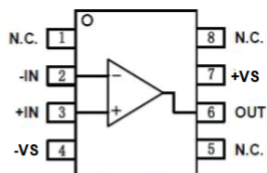

**8541A**  
SOP-8

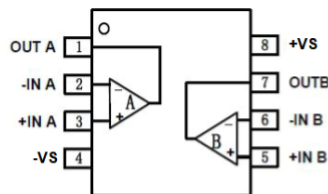

**8542A**  
MSOP-8/SOP-8/TSSOP-8

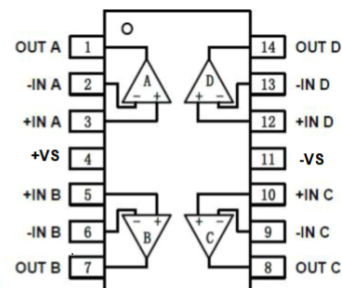

**8544A**  
TSSOP-14/SOP-14

Symbol	Description
-IN	Negative (inverting) input
+IN	Positive (noninverting) input.
-INA, -INB -INC, -IND	Inverting Input of the Amplifier. The voltage range can go from ( $V_{S-} - 0.2V$ ) to ( $V_{S+} + 0.2V$ ).
+INA, +INB +INC, +IND	Non-Inverting Input of Amplifier. This pin has the same voltage range as -IN.
+V <sub>S</sub>	Positive Power Supply. The voltage is from 2.3V to 5.5V. Split supplies are possible as long as the voltage between $V_{S+}$ and $V_{S-}$ is between 2.3V and 5.5V. A bypass capacitor of 0.1µF as close to the part as possible should be used between power supply pins or between supply pins and ground.
-V <sub>S</sub>	Negative Power Supply. It is normally tied to ground. It can also be tied to a voltage other than ground as long as the voltage between $V_{S+}$ and $V_{S-}$ is from 2.7V to 5.5V. If it is not connected to ground, bypass it with a capacitor of 0.1µF as close to the part as possible.
OUTA, OUTB OUTC, OUTD	The output of the Amplifier.
OUT	Output.
NC	No Connection.

### Absolute Maximum Ratings (T<sub>A</sub> = 25°C)

Symbol	Description	Value	Units
V <sub>S+</sub> , V <sub>S-</sub>	Supply Voltage, V <sub>S+</sub> to V <sub>S-</sub>	7.0	V
V <sub>CM</sub>	Common-Mode Input Voltage	V <sub>S-</sub> - 0.4 to V <sub>S+</sub> + 0.4	V
ESD	Electrostatic Discharge Voltage	HBM ±4000	V
		CDM ±2000	V
T <sub>J</sub>	Junction Temperature	160	°C
T <sub>STG</sub>	Storage Temperature Range	-65 to +150	°C(TJ)
T <sub>JL</sub>	Lead Temperature Range (Soldering 10 sec)	260	°C

**Notes:**

1. Stresses beyond those listed under Absolute Maximum Ratings may cause permanent damage to the device. These are stress ratings only, which do not imply functional operation of the device at these or any other conditions beyond those indicated under Recommended Operating Conditions. Exposure to absolute-maximum-rated conditions for extended periods may affect device reliability.
2. Provided device does not exceed maximum junction temperature (T<sub>J</sub>) at any time.

### Electrical Characteristics

$V_S = 5.0V$ ,  $T_A = +25^\circ C$ ,  $V_{CM} = V_S/2$ ,  $V_O = V_S/2$ , and  $R_L = 10k\Omega$  connected to  $V_S/2$ , unless otherwise noted.

Symbol	Parameter	Conditions	Min.	Typ.	Max.	Unit
<b>INPUT CHARACTERISTICS</b>						
$V_{OS}$	Input offset voltage		-3.5	$\pm 0.5$	+3.5	mV
	Over temperature		-4		+4	
$V_{OS\ TC}$	Offset voltage drift	Over Temperature		2		$\mu V/^\circ C$
$I_B$	Input bias current			1		pA
	Over temperature			500		
$I_{OS}$	Input offset current			1		
$V_{CM}$	Common-mode voltage range		$V_{S-} - 0.2$		$V_{S+} + 0.2$	V
$CMRR$	Common-mode rejection ratio	$V_{CM} = 0.05\ V\ to\ 3.5\ V$		95		dB
	Over temperature			85		
		$V_{CM} = V_{S-} - 0.1\ to\ V_{S+} + 0.1\ V$		80		
$A_{VOL}$	Open-loop voltage gain	$V_O = 0.05\ to\ 3.5\ V$		115		
	Over temperature			100		
$R_{IN}$	Input resistance		100			$G\Omega$
$C_{IN}$	Input capacitance	Differential		2.0		pF
		Common mode		3.5		
<b>OUTPUT CHARACTERISTICS</b>						
$V_{OH}$	High output voltage swing			$V_{S+} - 7$		mV
$V_{OL}$	Low output voltage swing			7		mV
$Z_{OUT}$	Closed-loop output impedance	$f = 200kHz, G = +1$		0.4		$\Omega$
	Open-loop output impedance	$f = 1MHz, I_o = 0$		2.6		
$I_{SC}$	Short-circuit current	Source current through $10\Omega$		40		mA
		Sink current through $10\Omega$		40		
<b>DYNAMIC PERFORMANCE</b>						
GBW	Gain bandwidth product	$f = 1kHz$		1.1		MHz
$\Phi_M$	Phase margin	$C_L = 100pF$		60		$^\circ$
SR	Slew rate	$G = +1, C_L = 100pF, V_O = 1.5V\ to\ 3.5V$		0.8		$V/\mu s$

## Electrical Characteristics

$V_S = 5.0V$ ,  $T_A = +25^\circ C$ ,  $V_{CM} = V_S/2$ ,  $V_O = V_S/2$ , and  $R_L = 10k\Omega$  connected to  $V_S/2$ , unless otherwise noted.

Symbol	Parameter	Conditions	Min.	Typ.	Max.	Unit
$t_s$	Settling time	To 0.1%, $G = +1$ , 2V step		4.5		$\mu s$
		To 0.01%, $G = +1$ , 2V step		5.5		
THD+N	Total harmonic distortion+Noise	$f = 1kHz$ , $G = +1$ , $V_O = 3V_{PP}$		0.002		%
<b>NOISE PERFORMANCE</b>						
$V_n$	Input voltage noise	$f = 0.1$ to 10 Hz		12		$\mu V_{P-P}$
$e_n$	Input voltage noise density	$f = 1kHz$		35		$nV/\sqrt{Hz}$
$I_n$	Input current noise density	$f = 10kHz$		4		$fA/\sqrt{Hz}$
<b>POWER SUPPLY</b>						
$V_S$	Operating supply voltage		2.3		5.5	V
PSRR	Power supply rejection ratio	$V_S = 2.7V$ to $5.5V$ , $V_{CM} < V_{S+} - 2V$		105		dB
	Over temperature			90		
$I_Q$	Quiescent current (per amplifier)			85		$\mu A$
	Over temperature			90		
<b>THERMAL CHARACTERISTICS</b>						
$T_A$	Operating temperature range		-40		+125	$^\circ C$
$\theta_{JA}$	Thermal resistance	SC70-5		333		$^\circ C/W$
		SOT23-5		190		
		MSOP-8		216		
		TSSOP-8	6	153		
		SOP-8		125		
		TSSOP-14		112		
		SOP-14		115		

Specifications subject to changes without notice

## Typical Performance Characteristics

At  $T_A = +25^\circ\text{C}$ ,  $V_{CM} = V_S/2$ , and  $R_L = 10\text{k}\Omega$  connected to  $V_S/2$ , unless otherwise noted.

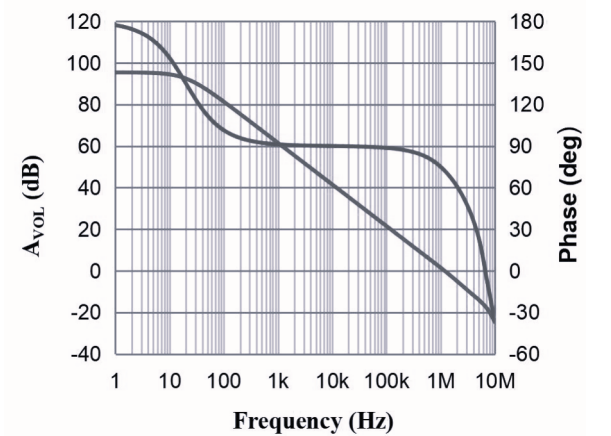

Open-loop Gain and Phase as a function of Frequency

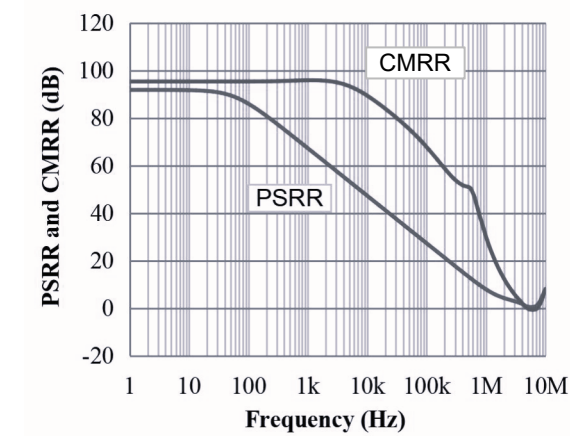

Power Supply and Common-mode Rejection Ratio as a function of Frequency

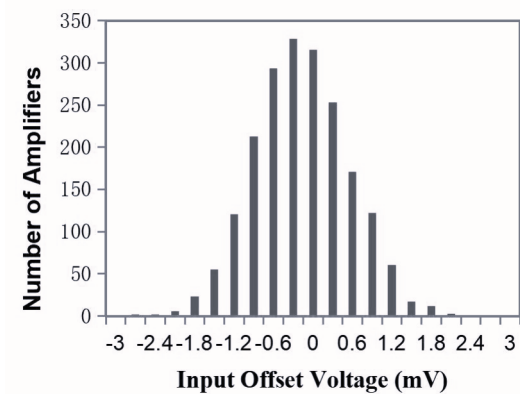

Input Offset Voltage Production Distribution

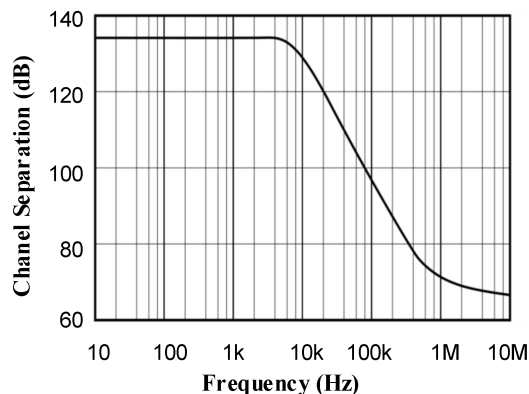

Channel Separation as a function of Frequency

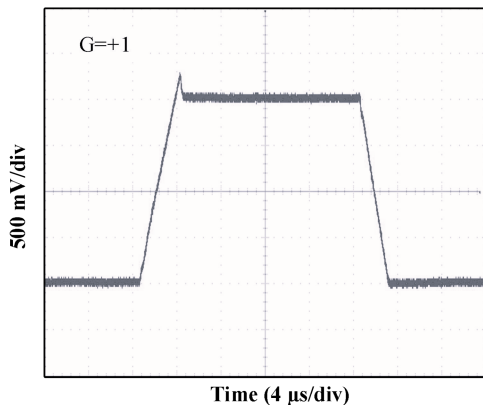

Large-Signal Step Response at 2.7V

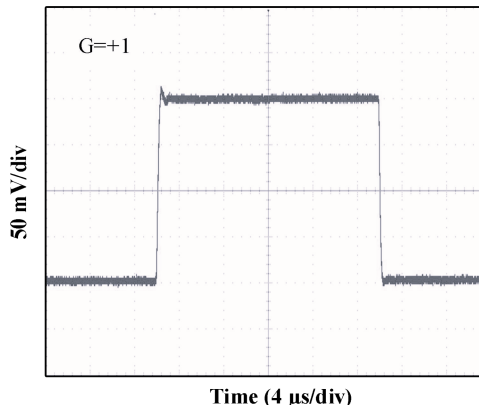

Small-Signal Step Response at 2.7V

## Typical Performance Characteristics

At  $T_A = +25^\circ\text{C}$ ,  $V_{CM} = V_S/2$ , and  $R_L = 10\text{k}\Omega$  connected to  $V_S/2$ , unless otherwise noted.

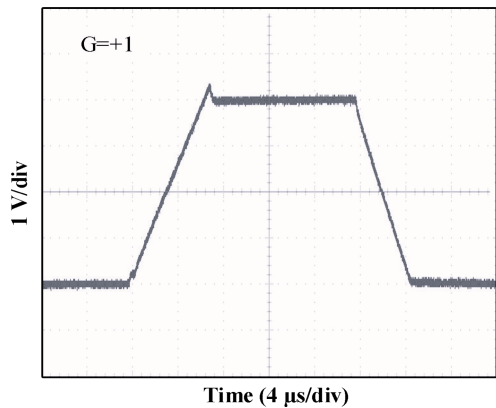

Large-Signal Step Response at 5V

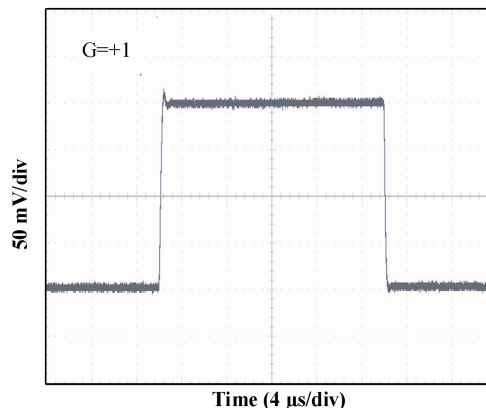

Small-Signal Step Response at 5V

## Application Notes

### LOW INPUT BIAS CURRENT

The AD854x family is a CMOS op-amp family and features very low input bias current in pA range. The low input bias current allows the amplifiers to be used in applications with high resistance sources. Care must be taken to minimize PCB Surface Leakage. See below section on “PCB Surface Leakage” for more details.

### PCB SURFACE LEAKAGE

In applications where low input bias current is critical, Printed Circuit Board (PCB) surface leakage effects need to be considered. Surface leakage is caused by humidity, dust or other contamination on the board. Under low humidity conditions, a typical resistance between nearby traces is  $10^{12}\Omega$ . A 5V difference would cause 5pA of current to flow, which is greater than the AD854xA’s input bias current at +25°C ( $\pm 1\text{pA}$ , typical). It is recommended to use multi-layer PCB layout and route the op-amp’s -IN and +IN signal under the PCB surface.

The effective way to reduce surface leakage is to use a guard ring around sensitive pins (or traces). The guard ring is biased at the same voltage as the sensitive pin. An example of this type of layout is shown in Figure 1 for Inverting Gain application.

1. For Non-Inverting Gain and Unity-Gain Buffer:

a) Connect the non-inverting pin (+IN) to the input with a wire that does not touch the PCB surface.

b) Connect the guard ring to the inverting input pin (-IN). This biases the guard ring to the Common Mode input voltage.

2. For Inverting Gain and Trans-impedance Gain Amplifiers(convert current to voltage, such as photo detectors):

a) Connect the guard ring to the non-inverting input pin (+IN). This biases the guard ring to the same reference voltage as the op-amp (e.g.,  $V_s/2$  or ground).

b) Connect the inverting input pin (-IN) to the input with a wire that does not touch the PCB surface.

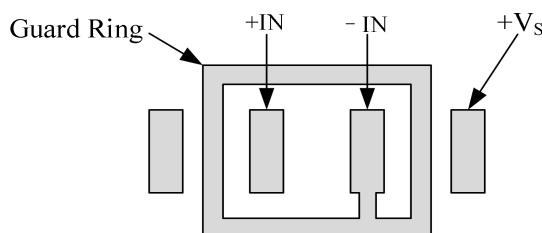

Figure 1 Use a guard ring around sensitive pins



## Application Notes

### GROUND SENSING AND RAIL TO RAIL

The input common-mode voltage range of the AD854xA series extends 200mV beyond the supply rails. This is achieved with a complementary input stage—an N-channel input differential pair in parallel with a P-channel differential pair. For normal operation, inputs should be limited to this range. The absolute maximum input voltage is 400mV beyond the supplies. Inputs greater than the input common-mode range but less than the maximum input voltage, while not valid, will not cause any damage to the op-amp. Unlike some other op-amps, if input current is limited, the inputs may go beyond the supplies without phase inversion, as shown in Figure 2. Since the input common-mode range extends from  $(V_{S-} - 0.2V)$  to  $(V_{S+} + 0.2V)$ , the AD854xA op-amps can easily perform ‘true ground’ sensing.

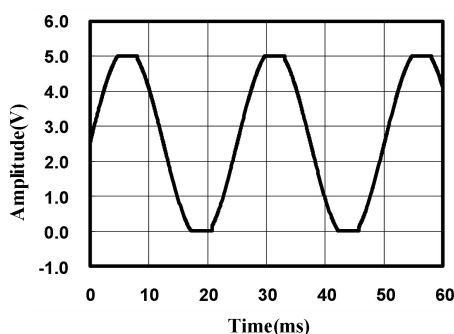

Figure 2 No Phase Inversion with Inputs Greater Than the Power-Supply Voltage

A topology of class AB output stage with common-source transistors is used to achieve rail-to-rail output. For light resistive loads (e.g. 100kΩ), the output voltage can typically swing to within 5mV from the supply rails. With moderate resistive loads (e.g. 10kΩ), the output can typically swing to within 10mV from the supply rails and maintain high open-loop gain.

The maximum output current is a function of total supply voltage. As the supply voltage to the amplifier increases, the output current capability also increases. Attention must be paid to keep the junction temperature of the IC below 150°C when the output is in continuous short-circuit. The output of the amplifier has reverse-biased ESD diodes connected to each supply. The output should not be forced more than 0.5V beyond either supply, otherwise current will flow through these diodes.

### CAPACITIVE LOAD AND STABILITY

The AD854xA can directly drive 1nF in unity-gain without oscillation. The unity-gain follower is the most sensitive configuration to capacitive loading. Direct capacitive loading reduces the phase margin of amplifiers and this results in ringing or even oscillation. Applications that require greater capacitive drive capability should use an isolation resistor

## Application Notes

between the output and the capacitive load like the circuit in Figure 3. The isolation resistor  $R_{ISO}$  and the load capacitor  $C_L$  form a zero to increase stability. The bigger the  $R_{ISO}$  resistor value, the more stable  $V_{OUT}$  will be. Note that this method results in a loss of gain accuracy because  $R_{ISO}$  forms a voltage divider with the  $R_L$ .

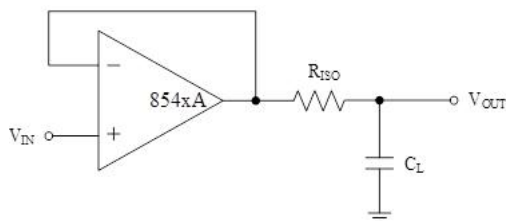

**Figure 3 Indirectly Driving Heavy Capacitive Load**

An improvement circuit is shown in Figure 4. It provides DC accuracy as well as AC stability. The  $R_F$  provides the DC accuracy by connecting the inverting signal with the output.

The  $C_F$  and  $R_{ISO}$  serve to counteract the loss of phase margin by feeding the high frequency component of the output signal back to the amplifier's inverting input, thereby preserving phase margin in the overall feedback loop.

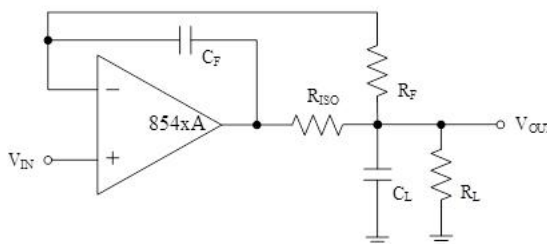

**Figure 4 Indirectly Driving Heavy Capacitive Load with DC Accuracy**

For no-buffer configuration, there are two others ways to increase the phase margin: (a) by increasing the amplifier's gain, or (b) by placing a capacitor in parallel with the feedback resistor to counteract the parasitic capacitance associated with inverting node.

## POWER SUPPLY LAYOUT AND BYPASS

The AD854xA family operates from either a single +2.3V to +5.5V supply or dual  $\pm 1.15V$  to  $\pm 2.75V$  supplies. For single-supply operation, bypass the power supply  $V_S$  with a ceramic capacitor (i.e.  $0.01\mu F$  to  $0.1\mu F$ ) which should be placed close (within 2mm for good high frequency performance) to the  $V_S$  pin. For dual-supply operation, both the  $V_{S+}$  and the

$V_{S-}$  supplies should be bypassed to ground with separate 0.1 $\mu$ F ceramic capacitors. A bulk capacitor (i.e. 2.2 $\mu$ F or larger tantalum capacitor) within 100mm to provide large, slow currents and better performance. This bulk capacitor can be shared with other analog parts.

Good PC board layout techniques optimize performance by decreasing the amount of stray capacitance at the op-amp's inputs and output. To decrease stray capacitance, minimize trace lengths and widths by placing external components as close to the device as possible. Use surface-mount components whenever possible. For the op-amp, soldering the part to the board directly is strongly recommended. Try to keep the high frequency big current loop area small to minimize the EMI (electromagnetic interfacing).

### **GROUNDING**

A ground plane layer is important for the AD854xA circuit design. The length of the current path speed currents in an inductive ground return will create an unwanted voltage noise. Broad ground plane areas will reduce the parasitic inductance.

### **INPUT-TO-OUTPUT COUPLING**

To minimize capacitive coupling, the input and output signal traces should not be parallel. This helps reduce unwanted positive feedback.

## Typical Application Circuits

### DIFFERENTIAL AMPLIFIER

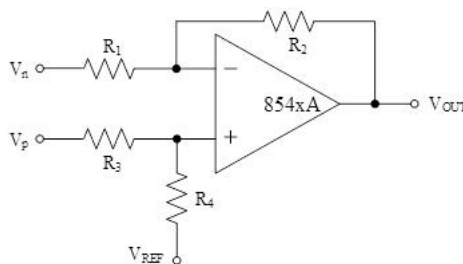
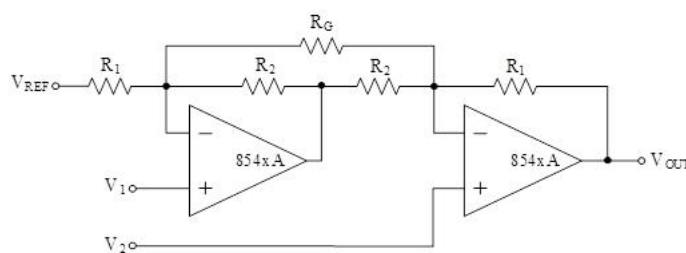

Figure 5 Differential Amplifier

The circuit shown in Figure 5 performs the difference function. If the resistors ratios are equal  $R_4/R_3 = R_2/R_1$ , then:

$$V_{OUT} = (V_p - V_n) \times R_2/R_1 + V_{REF}$$

### INSTRUMENTATION AMPLIFIER



$$V_{OUT} = (V_1 - V_2) \times (1 + R_1/R_2 + 2R_1/R_G) + V_{REF}$$

Figure 6 Instrumentation Amplifier

The AD854xA family is well suited for conditioning sensor signals in battery-powered applications. Figure 6 shows a two op-amp instrumentation amplifier, using the AD854xA op-amps. The circuit works well for applications requiring rejection of common-mode noise at higher gains. The reference voltage ( $V_{REF}$ ) is supplied by a low-impedance source. In single voltage supply applications, the  $V_{REF}$  is typically  $V_S/2$ .

## Typical Application Circuits

### BUFFERED CHEMICAL SENSORS

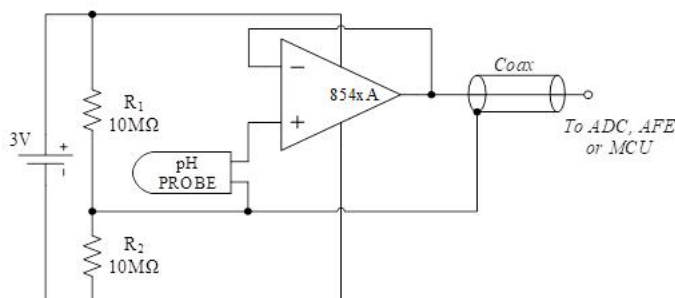

Figure 7 Buffered pH Probe

The AD854xA family has input bias current in the pA range. This is ideal in buffering high impedance chemical sensors, such as pH probes. As an example, the circuit in Figure 7 eliminates expensive low-leakage cables that that is required to connect a pH probe (general purpose combination pH probes, e.g. Corning 476540) to metering ICs such as ADC, AFE and/or MCU. An AD854xA op-amp and a lithium battery are housed in the probe assembly. A conventional low-cost coaxial cable can be used to carry the op-amp’s output signal to subsequent ICs for pH reading.

### SHUNT-BASED CURRENT SENSING AMPLIFIER

The current sensing amplification shown in Figure 8 has a slew rate of  $2\pi fV_{PP}$  for the output of sine wave signal, and has a slew rate of  $2fV_{PP}$  for the output of triangular wave signal. In most of motor control systems, the PWM frequency is at 10kHz to 20kHz, and one cycle time is 100µs for a 10kHz of PWM frequency. In current shunt monitoring for a motor phase, the phase current is converted to a phase voltage signal for ADC sampling. This sampling voltage signal must be settled before entering the ADC. As the Figure 8 shown, the total settling time of a current shunt monitor circuit includes: the rising edge delay time ( $t_{SR}$ ) due to the op-amp’s slew rate, and the measurement settling time ( $t_{SET}$ ). For a 3-shunt solution in motor phase current sensing, if the smaller duty cycle of the PWM is defined at 45% (In fact, the phase with minimum PWM duty cycle, such as 5%, is not detected current directly, and it can be calculated from the other two phase currents), and the  $t_{SR}$  is required at 20% of a total time window for a phase current monitoring, in case of a 3.3V motor control system

## Typical Application Circuits

(3.3V MCU with 12-bit ADC), the op-amp's slew rate should be more than:

$$3.3V / (100\mu s \times 45\% \times 20\%) = 0.37 V/\mu s$$

At the same time, the op-amp's bandwidth should be much greater than the PWM frequency, like 10 times at least.

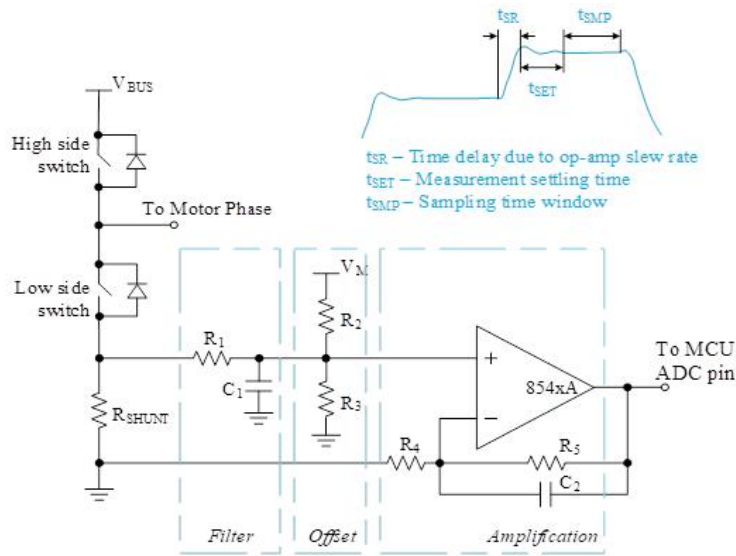
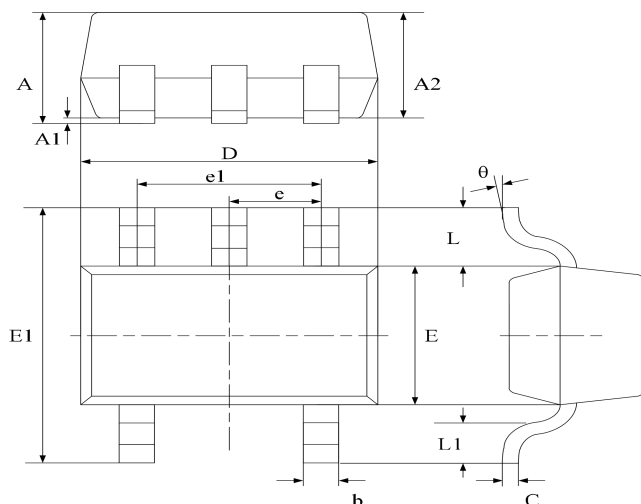

Figure 8 Current Shunt Monitor Circuit

## Package Information

### SC70-5 (SOT353)



Symbol	Dimensions In Millimeters		Dimensions In Inches	
	Min	Max	Min	Max
A	0.800	1.100	0.035	0.043
A1	0.000	0.100	0.000	0.004
A2	0.800	0.900	0.035	0.039
b	0.150	0.350	0.006	0.014
C	0.080	0.150	0.003	0.006
D	1.8500	2.150	0.079	0.087
E	1.100	1.400	0.045	0.053
E1	1.950	2.200	0.085	0.096
e	0.850 typ.		0.026 typ.	
e1	1.200	1.400	0.047	0.055
L	0.42 ref.		0.021 ref.	
L1	0.260	0.460	0.010	0.018
θ	0°	8°	0°	8°

### SOT23-5

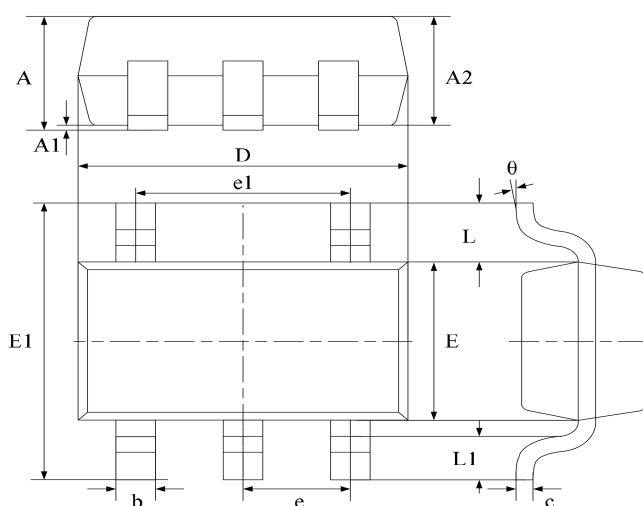

Symbol	Dimensions In Millimeters		Dimensions In Inches	
	Min	Max	Min	Max
A	1.040	1.350	0.042	0.055
A1	0.040	0.150	0.002	0.006
A2	1.000	1.200	0.041	0.049
b	0.380	0.480	0.015	0.020
c	0.110	0.210	0.004	0.009
D	2.720	3.120	0.111	0.127
E	1.400	1.800	0.057	0.073
E1	2.600	3.000	0.106	0.122
e	0.950 typ.		0.037 typ.	
e1	1.900 typ.		0.078 typ.	
L	0.700 ref.		0.028 ref.	
L1	0.300	0.600	0.012	0.024
θ	0°	8°	0°	8°

## Package Information

### MSOP-8

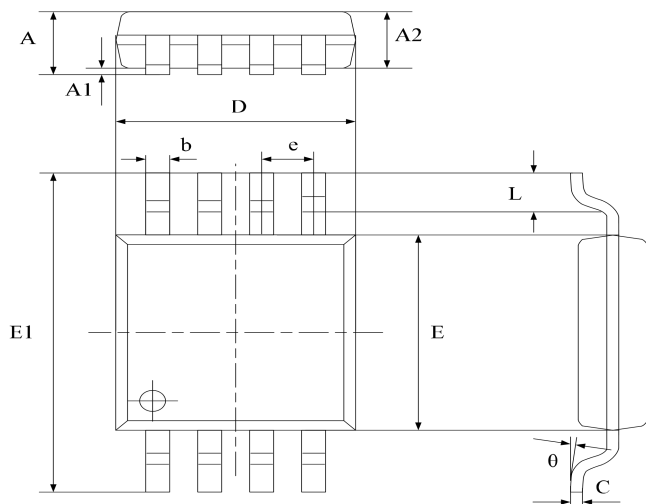

Symbol	Dimensions In Millimeters		Dimensions In Inches	
	Min	Max	Min	Max
A	0.800	1.100	0.033	0.045
A1	0.050	0.150	0.002	0.006
A2	0.750	0.950	0.031	0.039
b	0.290	0.380	0.012	0.016
C	0.150	0.200	0.006	0.008
D	2.900	3.100	0.118	0.127
E	2.900	3.100	0.118	0.127
E1	4.700	5.100	0.192	0.208
e	0.650typ.		0.026typ.	
L	0.400	0.700	0.016	0.029
θ	0°	8°	0°	8°

### SOP-8

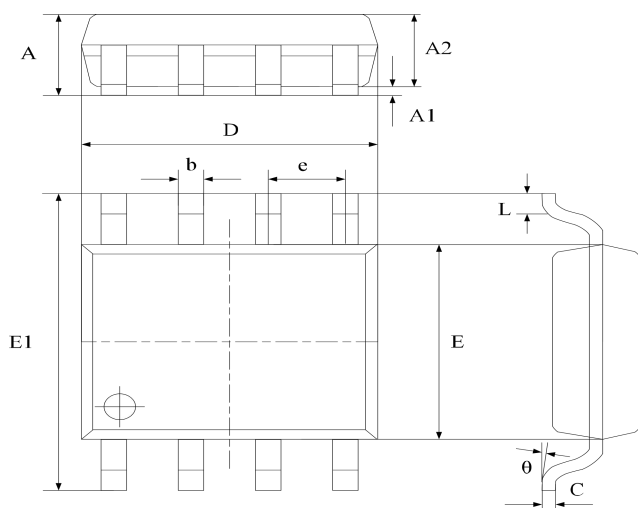

Symbol	Dimensions In Millimeters		Dimensions In Inches	
	Min	Max	Min	Max
A	1.370	1.670	0.056	0.068
A1	0.070	0.170	0.003	0.007
A2	1.300	1.500	0.053	0.061
b	0.306	0.506	0.013	0.021
C	0.203 typ.		0.008 typ.	
D	4.700	5.100	0.192	0.208
E	3.820	4.020	0.156	0.164
E1	5.800	6.200	0.237	0.253
e	1.270 typ.		0.050 typ.	
L	0.450	0.750	0.018	0.306
θ	0°	8°	0°	8°



## Package Information

### TSSOP-8

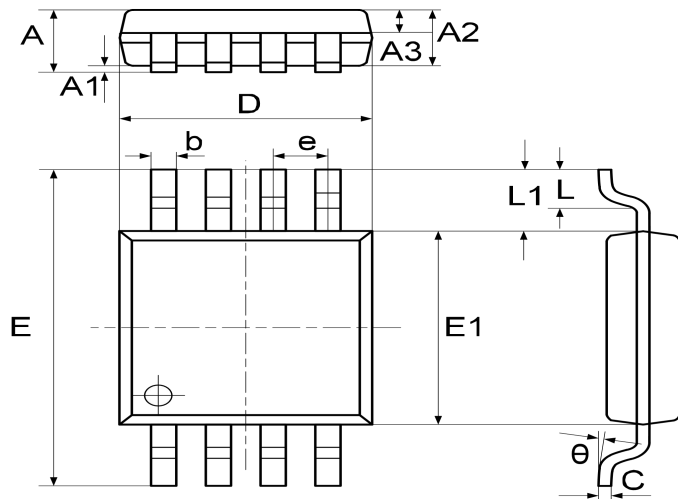

Symbol	Dimensions In Millimeters		
	Min	Nom	Max
A	-	-	1.200
A1	0.050	-	0.150
A2	0.900	1.000	1.050
A3	0.390	0.440	0.490
b	0.200	-	0.280
C	0.130	-	0.170
D	2.900	3.000	3.100
E	6.200	6.400	6.600
E1	4.300	4.400	4.500
e	0.65BSC		
L	0.450	-	0.750
L1	1.000 ref		
θ	0°	-	8°

## Package Information

### SOP-14

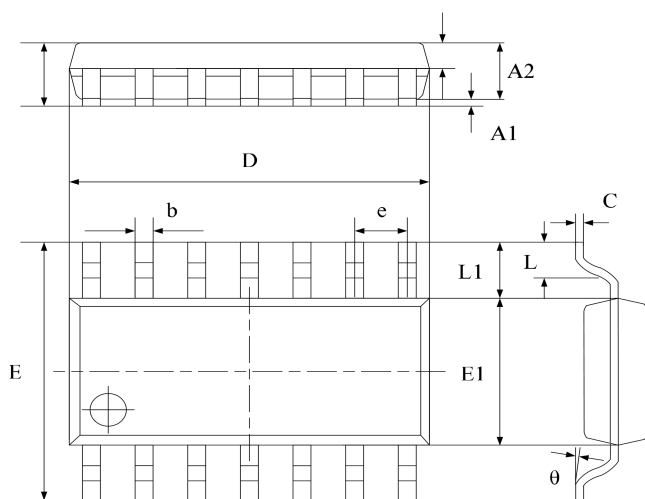

Symbol	Dimensions In Millimeters		Dimensions In Inches	
	Min	Max	Min	Max
A	1.450	1.850	0.059	0.076
A1	0.100	0.300	0.004	0.012
A2	1.350	1.550	0.055	0.063
A3	0.550	0.750	0.022	0.031
b	0.406typ.		0.017typ.	
C	0.203typ.		0.008typ.	
D	8.630	8.830	0.352	0.360
E	5.840	6.240	0.238	0.255
E1	3.850	4.050	0.157	0.165
e	1.270 typ.		0.050 typ.	
L1	1.040 ref.		0.041 ref.	
L	0.350	0.750	0.014	0.031
θ	2°	8°	2°	8°

## Package Information

### TSSOP-14

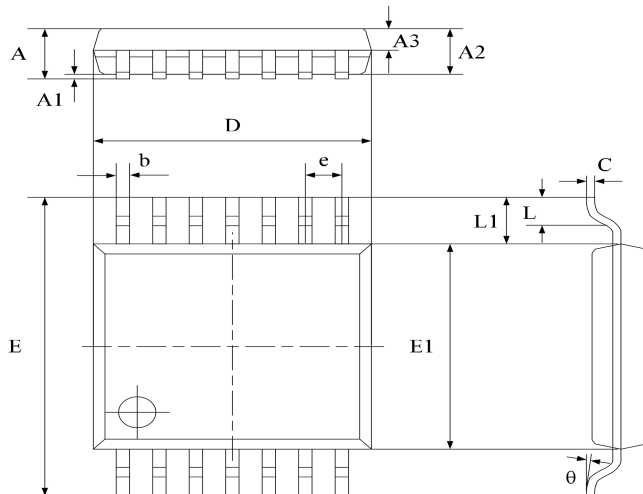

Symbol	Dimensions In Millimeters		Dimensions In Inches	
	Min	Max	Min	Max
A	-	1.200	-	0.0472
A1	0.050	0.150	0.002	0.006
A2	0.900	1.050	0.037	0.043
A3	0.390	0.490	0.016	0.020
b	0.200	0.290	0.008	0.012
C	0.130	0.180	0.005	0.007
D	4.860	5.060	0.198	0.207
E	6.200	6.600	0.253	0.269
E1	4.300	4.500	0.176	0.184
e	0.650 typ.		0.0256 typ.	
L1	1.000 ref.		0.0393 ref.	
L	0.450	0.750	0.018	0.031
θ	0°	8°	0°	8°

**Ordering information**

## X-ON Electronics

Largest Supplier of Electrical and Electronic Components

*Click to view similar products for [Operational Amplifiers - Op Amps](#) category:*

*Click to view products by [Youtai](#) manufacturer:*

Other Similar products are found below :

[430227FB](#) [LT1678IS8](#) [058184EB](#) [NCV33202DMR2G](#) [NJM324E](#) [M38510/13101BPA](#) [NTE925](#) [AZV358MTR-G1](#) [AP4310AUMTR-AG1](#)  
[AZV358MMTR-G1](#) [SCY33178DR2G](#) [NCV20034DR2G](#) [NTE778S](#) [NTE871](#) [NTE937](#) [NJU7057RB1-TE2](#) [SCY6358ADR2G](#)  
[NJM2904CRB1-TE1](#) [UPC4570G2-E1-A](#) [UPC4741G2-E1-A](#) [UPC4574GR-9LG-E1-A](#) [NJM8532RB1-TE1](#) [EL2250CS](#) [EL5100IS](#) [EL5104IS](#)  
[EL5127CY](#) [EL5127CYZ](#) [EL5133IW](#) [EL5152IS](#) [EL5156IS](#) [EL5162IS](#) [EL5202IY](#) [EL5203IY](#) [EL5204IY](#) [EL5210CS](#) [EL5210CYZ](#)  
[EL5211IYE](#) [EL5220CY](#) [EL5223CLZ](#) [EL5223CR](#) [EL5224ILZ](#) [EL5227CLZ](#) [EL5227CRZ](#) [EL5244CS](#) [EL5246CS](#) [EL5246CSZ](#) [EL5250IY](#)  
[EL5251IS](#) [EL5257IS](#) [EL5260IY](#)