

SOT-23 Plastic-Encapsulate Transistors

BAT54/A/C/S SCHOTTKY BARRIER DIODE

FEATURES

- Extremely Fast Switching Speed

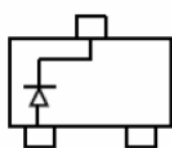
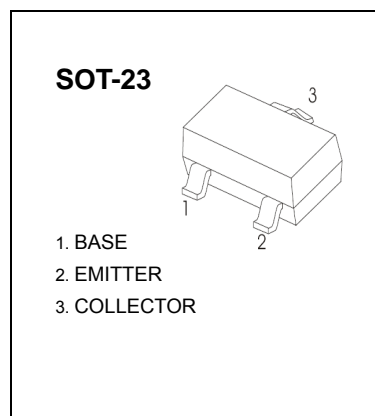

BAT54 MARKING: KL1/D3E

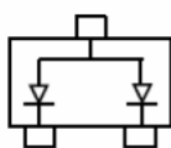

BAT54A MARKING: KL2

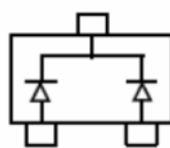

BAT54C MARKING: KL3

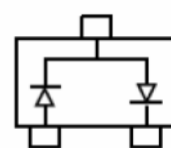

BAT54S MARKING: KL4

MAXIMUM RATINGS (T_a=25°C unless otherwise noted)

Parameter	Symbol	Value	Unit
Peak Repetitive Reverse Voltage	V _{RRM}	30	V
Working Peak Reverse Voltage	V _{RWM}		
DC Blocking Voltage	V _R		
Forward Continuous Current	I _{FM}	200	mA
Non-repetitive Peak Forward Surge Current @ t < 1s	I _{FSM}	600	mA
Repetitive Peak Forward Current @ t ≤ 1s, δ ≤ 0.5	I _{FRM}	300	mA
Power Dissipation	P _D	200	mW
Thermal Resistance from Junction to Ambient	R _{θJA}	500	°C/W
Junction Temperature	T _j	125	°C
Storage Temperature	T _{stg}	-55~+150	°C

ELECTRICAL CHARACTERISTICS(T_a=25°C unless otherwise specified)

Parameter	Symbol	Min	Typ	Max	Unit	Test conditions
Reverse voltage	V _(BR)	30			V	I _R =100μA
Forward voltage	V _F			0.24	V	I _{F1} =0.1mA
				0.32	V	I _{F2} =1mA
				0.40	V	I _{F3} =10mA
				0.50	V	I _{F4} =30mA
				1	V	I _{F5} =100mA
Reverse current	I _R			2	μA	V _R =25V
Diode capacitance	C _D			10	pF	V _R =1V, f=1MHz
Reverse recovery time	t _{rr}			5	ns	I _F =I _R =10mA I _{rr} =0.1 × I _R , R _L =100 Ω

Typical Characteristics

BAT54/A/C/S

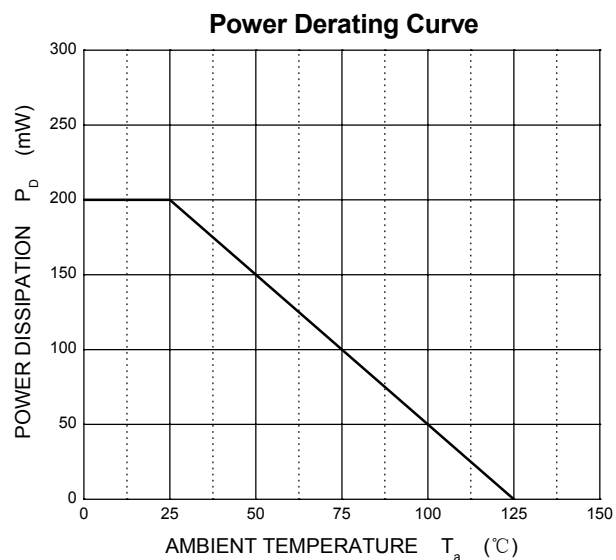
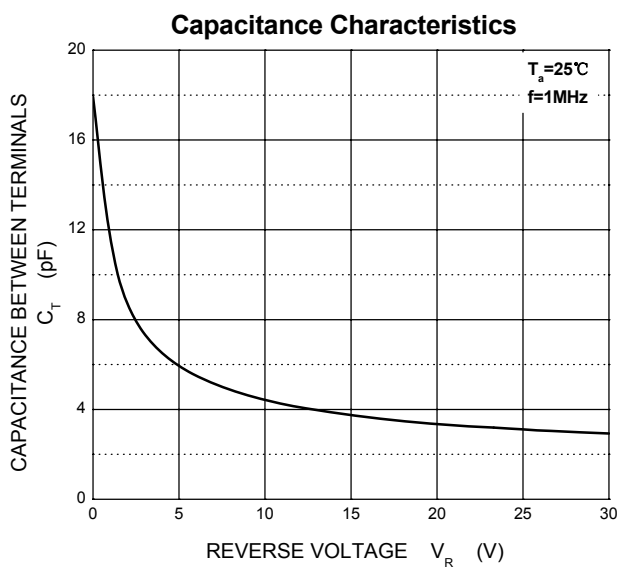
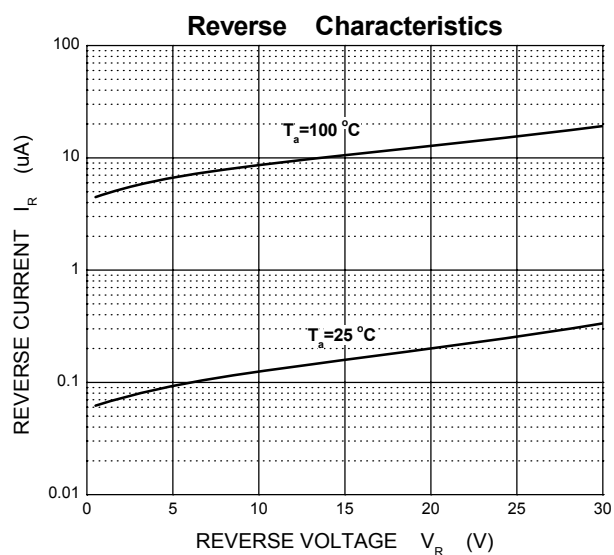
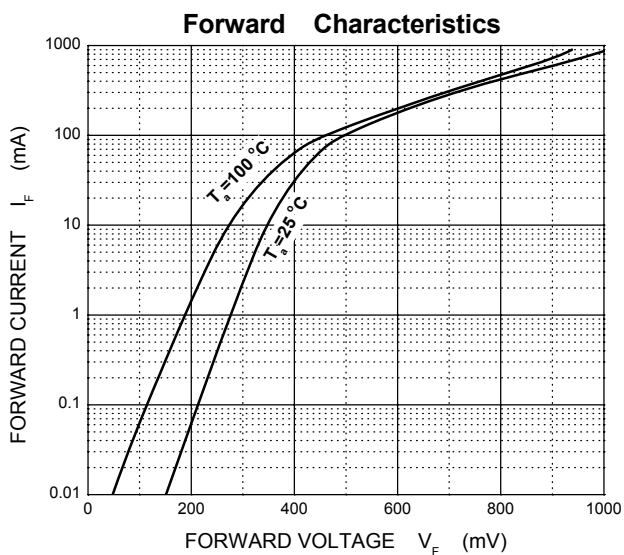

X-ON Electronics

Largest Supplier of Electrical and Electronic Components

Click to view similar products for [Schottky Diodes & Rectifiers](#) category:

Click to view products by [Youtai](#) manufacturer:

Other Similar products are found below :

[CUS06\(TE85L,Q,M\)](#) [MA4E2039](#) [D1FH3-5063](#) [MBR0530L-TP](#) [MBR10100CT-BP](#) [MBR30H100MFST1G](#) [MMBD301M3T5G](#) [PMAD1103-LF](#) [PMAD1108-LF](#) [RB160M-50TR](#) [RB520S-30](#) [RB551V-30](#) [DD350N18K](#) [DZ435N40K](#) [DZ600N16K](#) [BAS16E6433HTMA1](#) [BAS 3010S-02LRH E6327](#) [BAT 54-02LRH E6327](#) [IDL02G65C5XUMA1](#) [NSR05F40QNXT5G](#) [NSVR05F40NXT5G](#) [JANS1N6640](#) [SB07-03C-TB-H](#) [SB1003M3-TL-W](#) [SBAT54CWT1G](#) [SBM30-03-TR-E](#) [SBS818-TL-E](#) [SK32A-LTP](#) [SK33A-TP](#) [SK34A-TP](#) [SK34B-TP](#) [SMD1200PL-TP](#) [ACDBN160-HF](#) [SS3003CH-TL-E](#) [STPS30S45CW](#) [PDS3100Q-7](#) [GA01SHT18](#) [CRS10I30A\(TE85L,QM\)](#) [MBR1240MFST1G](#) [MBRB30H30CT-1G](#) [BAS28E6433HTMA1](#) [BAS 70-02L E6327](#) [HSB123JTR-E](#) [JANTX1N5712-1](#) [VS-STPS40L45CW-N3](#) [DD350N12K](#) [SB007-03C-TB-E](#) [SB10015M-TL-E](#) [SB1003M3-TL-E](#) [SK110-LTP](#)