

■ Features

- Extremely Fast Switching Speed
- Low forward voltage

■ Simplified outline(SOT-323)

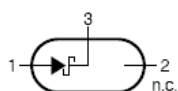
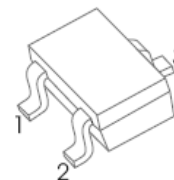

BAT54W

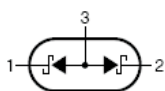

BAT54AW

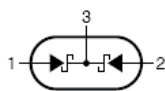

BAT54CW

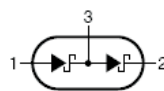

BAT54SW

■ Absolute Maximum Ratings $T_a = 25^\circ\text{C}$

Parameter	Symbol	Rating	Unit
Peak Repetitive Reverse Voltage	V_{RRM}	30	V
Working Peak Reverse Voltage	V_{RWM}		
DC Blocking Voltage	V_R		
Forward Continuous Current	I_{FM}	200	mA
Non-repetitive Peak Forward Surge Current @ $t=8.3\text{ms}$	I_{FSM}	600	
Repetitive Peak Forward Current @ $t \leq 1\text{s}, \delta \leq 0.5$	I_{FRM}	300	
Power Dissipation	P_D	200	mW
Thermal Resistance Junction to Ambient	$R_{\theta JA}$	500	$^\circ\text{C}/\text{W}$
Junction Temperature	T_J	125	$^\circ\text{C}$
Storage Temperature range	T_{stg}	-55 to 150	

■ Electrical Characteristics $T_a = 25^\circ\text{C}$

Parameter	Symbol	Test Conditions	Min	Typ	Max	Unit
Reverse Voltage	$V_{(BR)}$	$I_R = 100 \mu\text{A}$	30			V
Forward Voltage	V_{F1}	$I_F = 0.1 \text{ mA}$			0.24	
	V_{F2}	$I_F = 1 \text{ mA}$			0.32	
	V_{F3}	$I_F = 10 \text{ mA}$			0.40	
	V_{F4}	$I_F = 30 \text{ mA}$			0.50	
	V_{F5}	$I_F = 100 \text{ mA}$			1	
Leakage Current	I_R	$V_R = 25 \text{ V}$			2	μA
Diode Capacitance	C_D	$V_R = 0 \text{ V}, f = 1 \text{ MHz}$			10	pF
Reverse Recovery Time	t_{rr}	$I_F = I_R = 10 \text{ mA}, I_{rr} = 0.1 \times I_R, R_L = 100 \Omega$			5	ns

■ Typical Characteristics

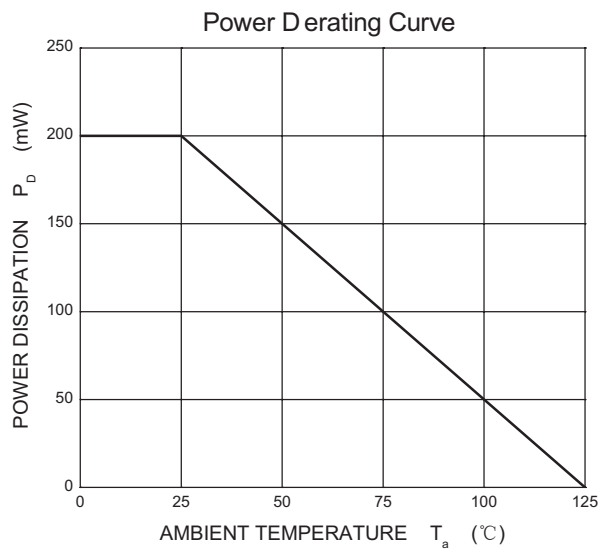
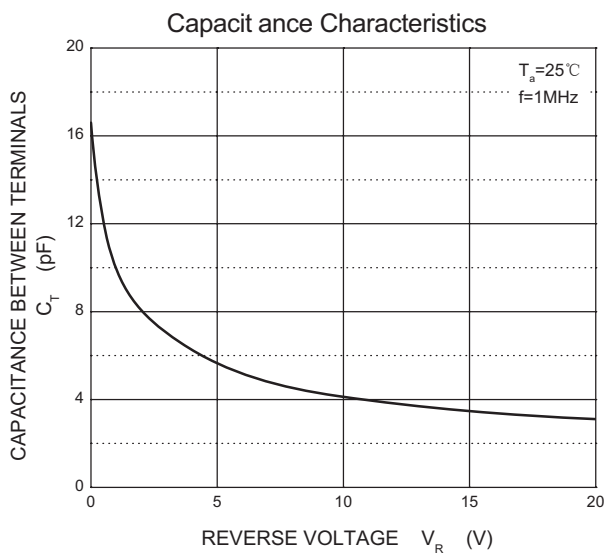
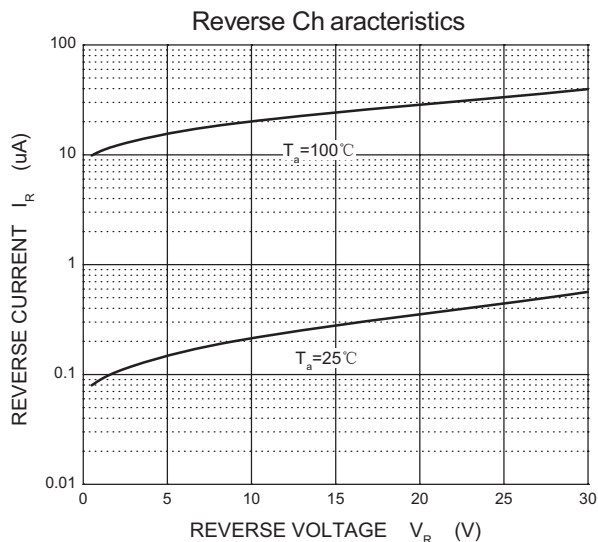
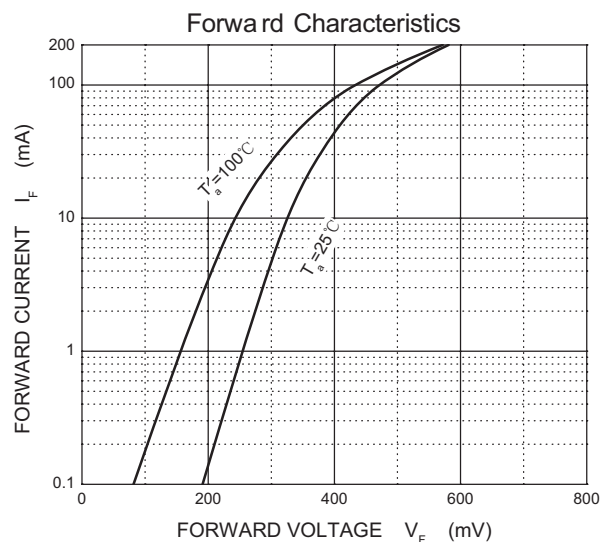

■ SOT-323

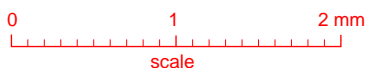
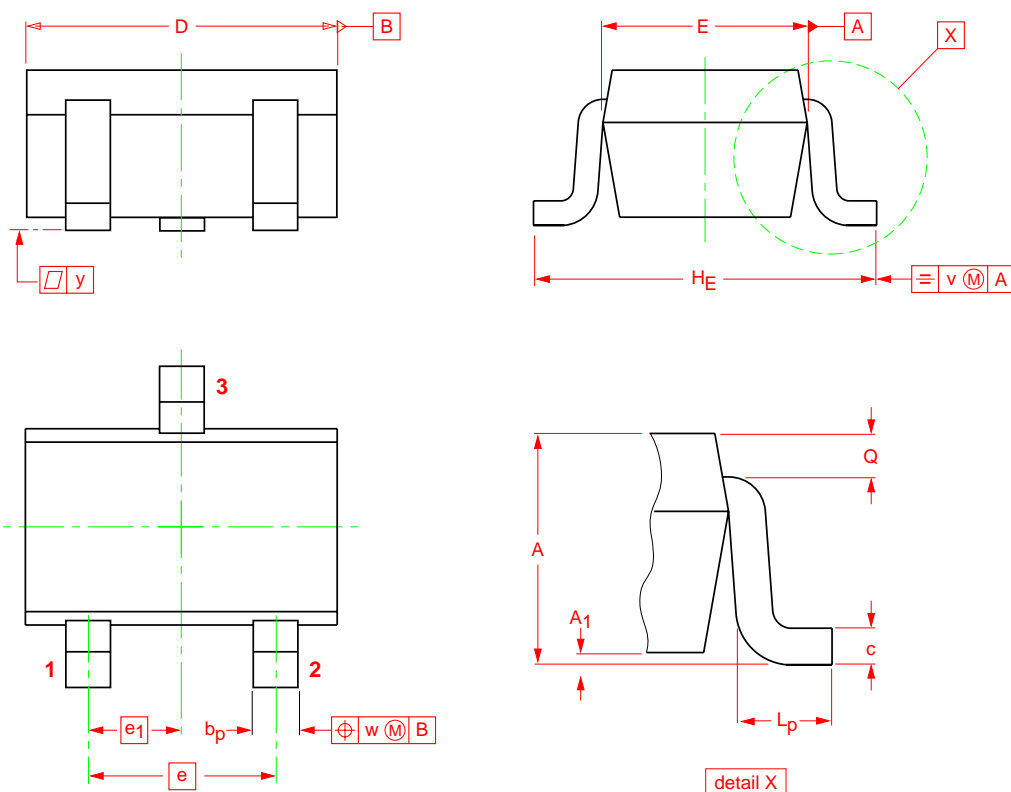

DIMENSIONS (mm are the original dimensions)

UNIT	A	A ₁ max	b _p	c	D	E	e	e ₁	H _E	L _p	Q	v	w
mm	1.1 0.8	0.1	0.4 0.3	0.25 0.10	2.2 1.8	1.35 1.15	1.3	0.65	2.2 2.0	0.45 0.15	0.23 0.13	0.2	0.2

■ Ordering information

Order Code	Package	Baseqty	Marking	Deliverymode
UMW BAT54W	SOT-323	3000	KL5 or L4	Tape and reel
UMW BAT54AW	SOT-323	3000	KL6 or L42	Tape and reel
UMW BAT54CW	SOT-323	3000	KL7 or L43	Tape and reel
UMW BAT54SW	SOT-323	3000	KL8 or L44	Tape and reel

X-ON Electronics

Largest Supplier of Electrical and Electronic Components

Click to view similar products for [Schottky Diodes & Rectifiers](#) category:

Click to view products by [Youtai](#) manufacturer:

Other Similar products are found below :

[MA4E2039](#) [MA4E2508M-1112](#) [MBR1545CT](#) [MMBD301M3T5G](#) [RB160M-50TR](#) [D83C](#) [BAS16E6433HTMA1](#) [BAT 54-02LRH E6327](#)
[NRVBAF360T3G](#) [NSR05F40QNXT5G](#) [NTE555](#) [JANS1N6640](#) [SK310-T](#) [SS3003CH-TL-E](#) [GA01SHT18](#) [CRS10I30A\(TE85L,QM](#)
[MA4E2501L-1290](#) [MBRA140TRPBF](#) [MBRB30H30CT-1G](#) [BAT 15-04R E6152](#) [JANTX1N5712-1](#) [DMJ3940-000](#) [SB007-03C-TB-E](#)
[SK33B-TP](#) [NRVBB20100CTT4G](#) [NRVBM120LT1G](#) [NTSB30U100CT-1G](#) [VS-6CWQ10FNHM3](#) [CRG04\(T5L,TEMQ\)](#) [ACDBA1100LR-HF](#)
[ACDBA1200-HF](#) [ACDBA240-HF](#) [ACDBA3100-HF](#) [CDBQC0530L-HF](#) [CDBQC0240LR-HF](#) [ACDBA260LR-HF](#) [ACDBA1100-HF](#)
[MA4E2502L-1246](#) [10BQ015-M3/5BT](#) [NRVBM120ET1G](#) [CRS08TE85LQM](#) [PMAD1108-LF](#) [B120Q-13-F](#) [1N5819T-G](#) [B0530WSQ-7-F](#)
[PDS1040Q-13](#) [B160BQ-13-F](#) [SDM05U20CSP-7](#) [B140S1F-7](#) [HSM560Je3/TR13](#)