

● **Product Characteristics and Main Uses.**

NPNPN five layer silicon bidirectional device; Single side trenching technology with independent intellectual property rights, table glass passivation process; Multilayer metallized electrode on the back; High blocking voltage and high temperature stability;

Mainly used for: vacuum cleaners, power tools and other motor speed controller; solid state relays; heating controller (temperature control); other phase control circuit.

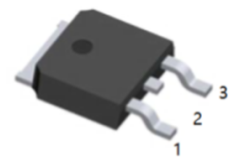
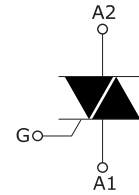

1.A1 2. A2 3.G  
TO-252(DPAK) top view

● **The limiting parameter**

Symbol	The name of the parameter		Values	Unit
$I_{T(RMS)}$	The through - state root - mean square current, the	BTA BTB	$T_c=80^{\circ}C$ $T_c=90^{\circ}C$	12 A
$I_{TSM}$	On state inrush current	F=50HZ	t=20ms	80 A
$I^2t$	Limit value of $I^2t$	tp=10ms		64 $A^2S$
di/dt	Critical rate of rise of on - state current		$T_j=125$	50 A/us

$V_{DRM}/V_{RRM}$	Break-state repetition peak voltage inverse repetition peak voltage, the		$T_j=25^{\circ}\text{C}$	600/800	V
$I_{GM}$	peak gate current	$t_p=20\mu\text{s}$	$T_j=125^{\circ}\text{C}$	4	A
$P_{G(AV)}$	The average power dissipated at the gate pole, the		$T_j=125^{\circ}\text{C}$	1	W
$T_{stg} T_j$	storage temperature effective junction temperature			- 40to+150 - 40to+125	$^{\circ}\text{C}$

• Electrical characteristics (three quadrants)

Symbol	name and test conditions	Quadrant		Values	Unit
$I_{GT}$	Trigger current $V_D=12\text{V}$ $R_L=100\Omega$	I	MAX	$\leq 50$	mA
$V_{GT}$	Trigger voltage	II	MAX	1.5	V
$V_{GD}$	Non triggering voltage $T_j=125^{\circ}\text{C}$	III	MIN	0.2	V
$I_H$	Maintenance current $I_T=0.5\text{A}$		MAX	60	mA
$I_L$	Dynaflex $I_G=1.2I_{GT}$		MAX	60 100	mA
$dv/dt$	Critical rate of rise of off-state voltage $V_D=2/3V_{DRM}$ $T_j=125^{\circ}\text{C}$		MIN	500	V/ $\mu\text{s}$
$(dv/dt)_c$	Critical rate of rise of commutation voltage $T_j=125^{\circ}\text{C}$		MIN	10	V/ $\mu\text{s}$

• Electrical characteristics (four quadrants)

Symbol	name and test conditions	Quadrant		Values	Unit
$I_{GT}$	Trigger current $V_D=12\text{V}$ $R_L=100\Omega$	I	MAX	I II III	mA
	Trigger voltage	II		$\leq 50$	
$V_{GT}$		III	MAX	1.5	V
		IV			

$V_{GD}$	Non triggering voltage $T_j=125^{\circ}C$		MIN	0.2	V
$I_H$	Maintenance current $I_T=0.5A$		MAX	60	mA
$I_L$	Holding current $I_G=1.2I_{GT}$		MAX	60	mA
				100	
$dv/dt$	Critical rate of rise of off-state voltage $V_D=2/3V_{DRM} \quad T_j=125^{\circ}C$		MIN	500	V/us
$(dv/dt)_c$	Critical rate of rise of commutation voltage $T_j=125^{\circ}C$		MIN	10	V/us

● static parameters

Symbol	name and test conditions			Values	Unit
$V_{TM}$	On state peak voltage $I_{TM}=16A$	$T_j=25^{\circ}C$	MAX	1.5	V
$V_{TO}$	threshold voltage	$T_j=125^{\circ}C$	MAX	0.86	V
$R_d$	slope resistance	$T_j=125^{\circ}C$	MAX	36.6	$m\Omega$
$I_{DRM} \quad I_{RRM}$	peak off - state current	$T_j=25^{\circ}C$	MAX	5	$\mu A$
	reverse peak current	$T_j=125^{\circ}C$		1	mA
$R_{th(j-c)}$	crust thermal resistance	BTA		2.05	$^{\circ}C/W$
		BTB		1.25	

● product characteristic curves

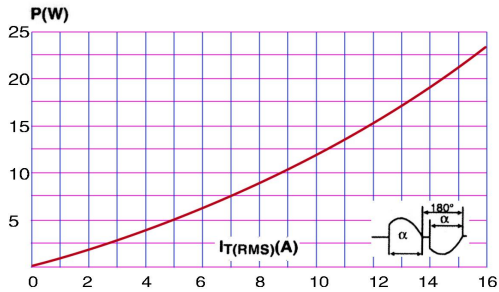

1、功耗与电流曲线 (180°C)

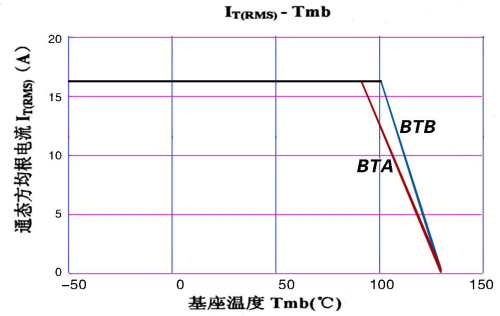

2、壳温与通态方均根电流曲线

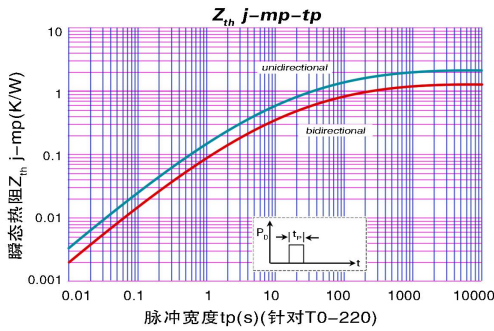

3、瞬态热阻曲线

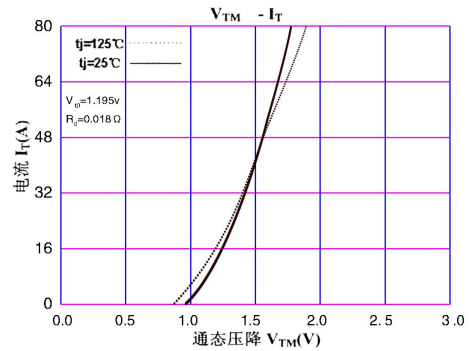

4、通态伏安特性曲线

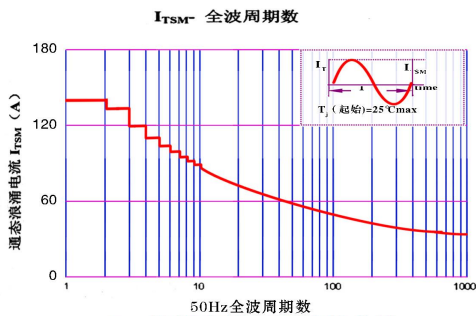

5、浪涌电流与周波数曲线

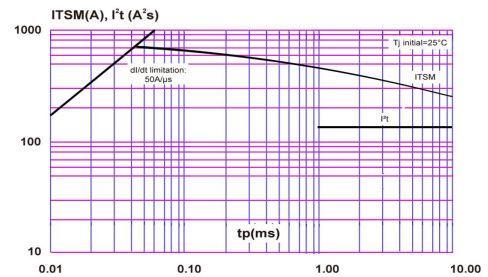

6、 $I_{TSM}-t, I^2t-t$  曲线

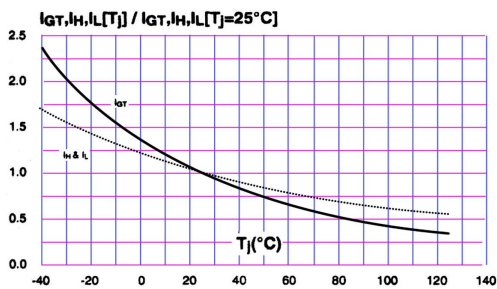

7、门极触发特性曲线

Package Mechanical Data TO-252

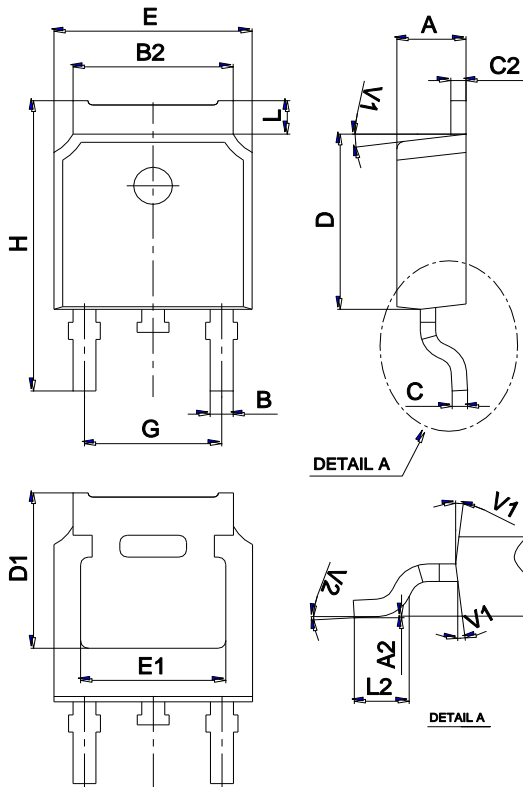

Ref.	Dimensions					
	Millimeters			Inches		
	Min.	Typ.	Max.	Min.	Typ.	Max.
A	2.10		2.50	0.083		0.098
A2	0		0.10	0		0.004
B	0.66		0.86	0.026		0.034
B2	5.18		5.48	0.202		0.216
C	0.40		0.60	0.016		0.024
C2	0.44		0.58	0.017		0.023
D	5.90		6.30	0.232		0.248
D1	5.30REF			0.209REF		
E	6.40		6.80	0.252		0.268
E1	4.63			0.182		
G	4.47		4.67	0.176		0.184
H	9.50		10.70	0.374		0.421
L	1.09		1.21	0.043		0.048
L2	1.35		1.65	0.053		0.065
V1		7°			7°	
V2	0°		6°	0°		6°

Ordering information

Order code	Package	Baseqty	Deliverymode
UMW BT137S-600E	TO-252	2500	Tape and reel
UMW BT137S-800E	TO-252	2500	Tape and reel

## X-ON Electronics

Largest Supplier of Electrical and Electronic Components

*Click to view similar products for [Youtai manufacturer](#):*

Other Similar products are found below :

[FQD20N06](#) [SS510](#) [BAV70](#) [UMW817C-S](#) [AOD2610E](#) [AO4421\(UMW\)](#) [AO4606](#) [HT7530-1](#) [AOD516\(UMW\)](#) [UMW817C](#) [SMAJ33CA](#)  
[BST23C052V\(UMW\)](#) [MMBTA42](#) [SMBJ28CA](#) [SMF6.0CA](#) [UCLAMP3301D](#) [BT139D-800E](#) [MAX809R](#) [SI2301B](#) [SMBJ188CA](#)  
[RCLAMP0524P](#) [P6SMB6.8CA](#) [4N35](#) [SS56C](#) [SMAJ15CA](#) [ESDA6V1L](#) [CEM9926A](#) [BSD5C031V\(UMW\)](#) [SMAJ5.0A](#) [FQP47P06\(UMW\)](#)  
[ESD05V52D](#) [MOC3021SM](#) [IRFR7546TR](#) [BSS123\(UMW\)](#) [D5V0L2B3SO-7\(UMW\)](#) [SMBJ6.8A](#) [UMW78M06](#) [MAX3232IDR\(UMW\)](#)  
[AOD442](#) [TPD1E10B06DPYR](#) [FDD8896](#) [MB10M\(0.8A\)](#) [PESD3V3S2UT](#) [MB10F\(0.8A\)](#) [ESD3Z5V0](#) [BAW56](#) [BST23A052V\(UMW\)](#)  
[SD08C](#) [MOC3043M](#) [FDN337N\(UMW\)](#)