

General Information

Portable communications, computing and video equipment manufacturers are challenging the semiconductor industry to develop increasingly smaller electronic components. The Transient Voltage Suppressor Array series offers a choice of voltage types ranging from 3 V to 24 V in a unidirectional or bidirectional configuration.

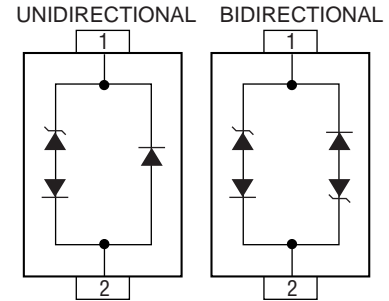

Features

- Protects one line or one I/O port
- Bidirectional configuration
- ESD protection 30 kV max.
- Low capacitance: ~3 pF typical

Applications

- Cellular phones
- PDAs and notebooks
- Digital cameras
- MP3 players and GPS
- USB interface

Electrical & Thermal Characteristics (@ T_A = 25 °C Unless Otherwise Noted)

Parameter	Symbol	Value	Unit
Peak Pulse Power (tp = 8/20 μs)	P _{PP}	350	W
Operating Temperature	T _J	-55 to +150	°C
Storage Temperature	T _{STG}	-55 to +150	°C

Parameter	Symbol	CDSOD323-								Unit
		Uni-T03	Bi-T03C	Uni-T05	Bi-T05C	Uni-T08	Bi-T08C	Uni-T12	Bi-T12C	
Minimum Breakdown Voltage @ 1 mA	V _{BR}	4.0		6.0		8.5		13.3		V
Working Peak Voltage	V _{WM}	3.3		5.0		8.0		12.0		V
Maximum Clamping Voltage @ I _P = 1 A	V _C	7.0		9.8		13.4		19.0		V
Typical Clamping Voltage @ 8/20 μs @ I _{PP}	V _C	19.0 V @ 20 A		18.3 V @ 17 A		18.5 V @ 17 A		28.3 V @ 11 A		V
Maximum Leakage Current @ V _{WM}	I _D	5		5		2		1		μA
Typical Capacitance @ 0 V, 1 MHz	C _J	3								pF

Parameter	Symbol	CDSOD323-						Unit
		Uni-T15	Bi-T15C	Uni-T18	Bi-T18C	Uni-T24	Bi-T24C	
Minimum Breakdown Voltage @ 1 mA	V _{BR}	16.7		20.0		26.7		V
Working Peak Voltage	V _{WM}	15.0		18.0		24.0		V
Maximum Clamping Voltage @ I _P = 1 A	V _C	24.0		29.0		43.0		V
Typical Clamping Voltage @ 8/20 μs @ I _{PP}	V _C	31.8 V @ 10 A		45.0 V @ 8 A		56.0 V @ 6 A		V
Maximum Leakage Current @ V _{WM}	I _D	1						μA
Typical Capacitance @ 0 V, 1 MHz	C _J	3						pF

Notes:

1. Part numbers with suffix "C" indicate bidirectional device, i.e. CDSOD323-T05C.
2. For bidirectional devices only, the electrical specifications apply in both directions.

CDSOD323-T03C - TVS Diode Array Series

Performance Graphs

Peak Pulse Power vs Pulse Time

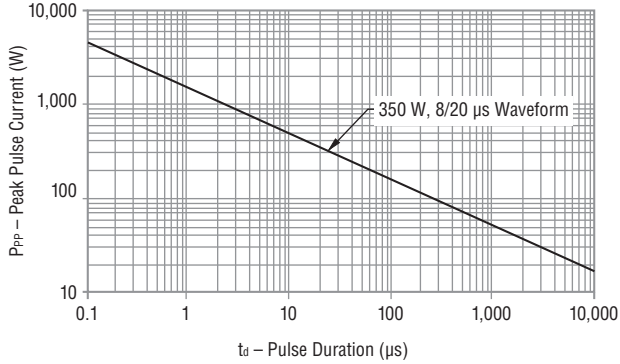

Pulse Waveform

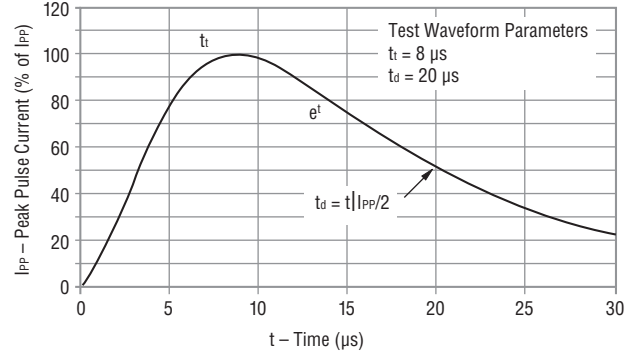

Block Diagram

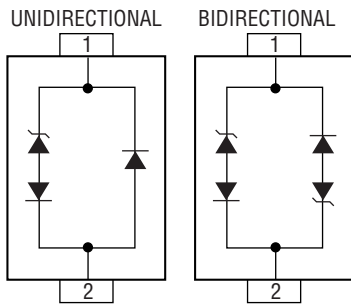

How to Order

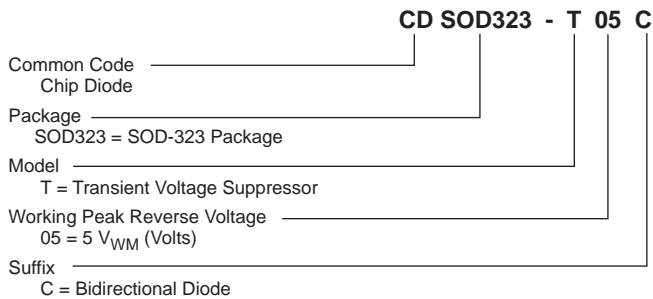

Outline Drawing – SOD-323

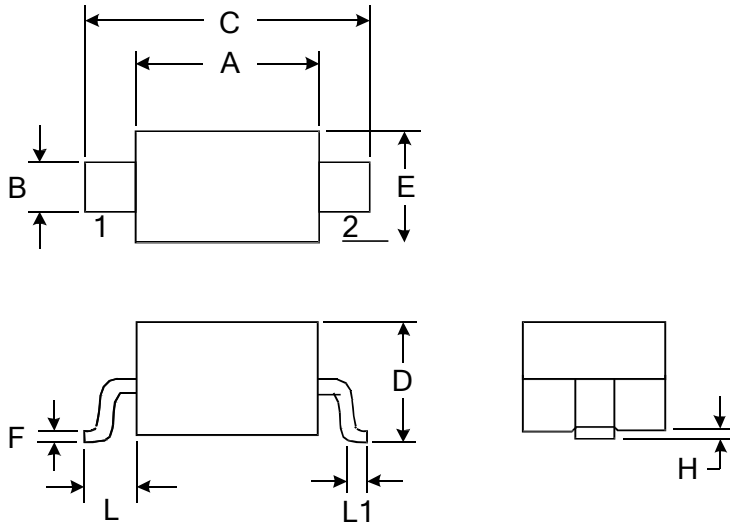

DIMENSIONS				
SYMBOL	MILLIMETER		INCHES	
	MIN	MAX	MIN	MAX
A	1.600	1.800	0.063	0.071
B	0.250	0.350	0.010	0.014
C	2.500	2.700	0.098	0.106
D		1.000		0.039
E	1.200	1.400	0.047	0.055
F	0.080	0.150	0.003	0.006
L	0.475 REF		0.019REF	
L1	0.250	0.400	0.010	0.016
H	0.000	0.100	0.000	0.004

Marking

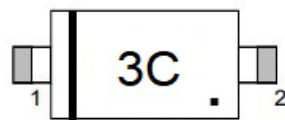

Ordering information

Order code	Marking	Package	Baseqty	Deliverymode
UMW CDSOD323-T03	3	SOD-323	3000	Tape and reel
UMW CDSOD323-T03C	3C	SOD-323	3000	Tape and reel
UMW CDSOD323-T05	5	SOD-323	3000	Tape and reel
UMW CDSOD323-T05C	5C	SOD-323	3000	Tape and reel
UMW CDSOD323-T08	8	SOD-323	3000	Tape and reel
UMW CDSOD323-T08C	8C	SOD-323	3000	Tape and reel
UMW CDSOD323-T12	2	SOD-323	3000	Tape and reel
UMW CDSOD323-T12C	2C	SOD-323	3000	Tape and reel
UMW CDSOD323-T15	6	SOD-323	3000	Tape and reel
UMW CDSOD323-T15C	6C	SOD-323	3000	Tape and reel
UMW CDSOD323-T18	1	SOD-323	3000	Tape and reel
UMW CDSOD323-T18C	1C	SOD-323	3000	Tape and reel
UMW CDSOD323-T24	4	SOD-323	3000	Tape and reel
UMW CDSOD323-T24C	4C	SOD-323	3000	Tape and reel

X-ON Electronics

Largest Supplier of Electrical and Electronic Components

Click to view similar products for [ESD Suppressors / TVS Diodes](#) category:

Click to view products by [Youtai](#) manufacturer:

Other Similar products are found below :

[60KS200C](#) [D18V0L1B2LP-7B](#) [D5V0F4U5P5-7](#) [NTE4902](#) [P4KE27CA](#) [P6KE11CA](#) [P6KE8.2A](#) [SA60CA](#) [SA64CA](#) [SMBJ12CATR](#)
[SMBJ33CATR](#) [SMBJ6.5A](#) [SMBJ8.0A](#) [ESD101-B1-02ELS E6327](#) [ESD112-B1-02EL E6327](#) [ESD7451N2T5G](#) [19180-510](#) [CPDT-5V0USP-](#)
[HF](#) [3.0SMCJ33CA-F](#) [3.0SMCJ36A-F](#) [HSPC16701B02TP](#) [JANTX1N6126A](#) [D3V3Q1B2DLP3-7](#) [D55V0M1B2WS-7](#) [SCM1293A-04SO](#)
[ESD200-B1-CSP0201 E6327](#) [SM12-7](#) [CEN955 W/DATA](#) [VESD12A1A-HD1-GS08](#) [CPDQC5V0-HF](#) [D1213A-01LP4-7B](#) [ESD101-B1-02EL](#)
[E6327](#) [AOZ8808DI-03](#) [5KP15A](#) [5KP48A](#) [5KP90A](#) [ESD3V3D7-TP](#) [15KPA36A-LF](#) [P4KE56CA](#) [P4KE68A](#) [P4KE91CATR](#) [P6KE120A](#)
[P6KE13CA](#) [P6KE43CA](#) [P6KE6.8CA](#) [P6KE8.2](#) [P6SMBJ20CA](#) [JANTX1N6072A](#) [SR2835ESKG](#) [SA90CA](#)