

DESCRIPTION

Designed to protect voltage sensitive electronic components from ESD and other transients. Excellent clamping capability, low leakage, and fast response time provide best in class protection on designs that are exposed to ESD.

The combination of small size, high level of ESD protection makes them a flexible solution for applications such as HDMI, Display Port TM, and MDDI interfaces. It is designed to replace multiplier varistors (MLV) in consumer equipments applications such as mobile phone, notebook, PAD, STB, LCD TV .



SOD-523

FEATURES

- Uni-directional ESD protection of one line
- Reverse stand-off voltage: 5V
- Low reverse clamping voltage
- Low leakage current
- Excellent package: 1.2mm×0.8mm×0.6mm
- Fast response time
- JESD22-A114-B ESD Rating of class 3B per human body model
- IEC 61000-4-2 Level 4 ESD protection

APPLICATIONS

- Computers and peripherals
- Audio and video equipment
- Cellular handsets and accessories
- Portable electronics
- Other electronics equipments communication systems

MAXIMUM RATINGS (T_a=25°C unless otherwise noted)

Parameter	Symbol	Limit	Unit
IEC 61000-4-2 ESD Voltage	Air Model	±25	kV
	Contact Model	±25	
	Per Human Body Model	±16	
	Machine Model	±0.4	
JESD22-A114-B ESD Voltage	V _{ESD} ⁽¹⁾		
ESD Voltage	P _{PP} ⁽²⁾	170	W
Peak Pulse Power	I _{PP} ⁽²⁾	13	A
Peak Pulse Current	T _L	260	°C
Lead Solder Temperature – Maximum (10 Second Duration)	T _j	150	°C
Junction Temperature	T _{stg}	-55 ~ +150	°C
Storage Temperature Range			

(1). Device stressed with ten non-repetitive ESD pulses.

(2). Non-repetitive current pulse 8/20µs exponential decay waveform according to IEC61000-4-5.

ESD standards compliance

Contact Discharge		Air Discharge	
Level	Test Voltage kV	Level	Test Voltage kV
1	2	1	2
2	4	2	4
3	6	3	8
4	8	4	15

ESD Class	Human Body Discharge V
0	0~249
1A	250~499
1B	500~999
1C	1000~1999
2	2000~3999
3A	4000~7999
3B	8000~15999

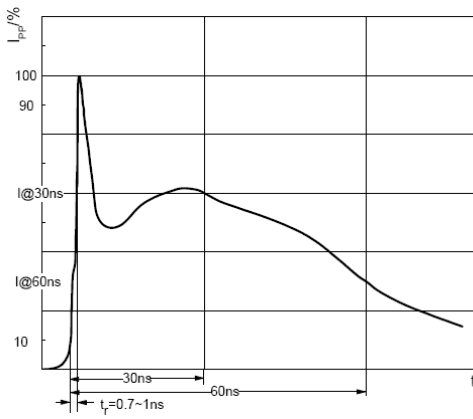

ESD pulse waveform according to IEC61000-4-2

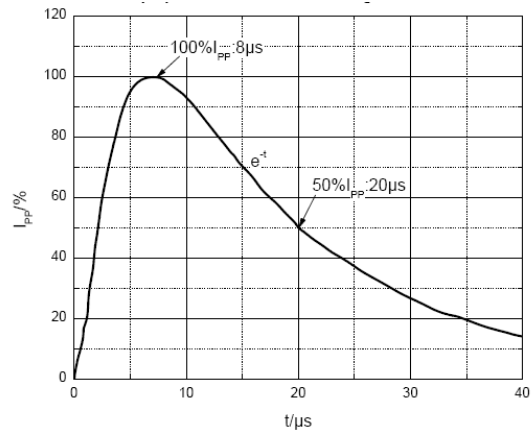

8/20µs pulse waveform according to IEC 61000-4-5

ELECTRICAL PARAMETER

Symbol	Parameter
V_C	Clamping Voltage @ I_{PP}
I_{PP}	Peak Pulse Current
V_{BR}	Breakdown Voltage @ I_T
I_T	Test Current
I_R	Reverse Leakage Current @ V_{RWM}
V_{RWM}	Reverse Standoff Voltage
V_F	Forward Voltage @ I_F
I_F	Forward Current

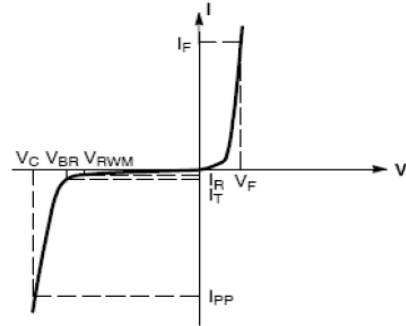

V-I characteristics for a uni-directional TVS

ELECTRICAL CHARACTERISTICS ($T_a=25^\circ\text{C}$ unless otherwise specified)

Parameter	Symbol	Test conditions	Min	Typ	Max	Unit
Reverse stand off voltage	$V_{RWM}^{(1)}$				5	V
Reverse leakage current	I_R	$V_{RWM}=5V$			10	μA
Breakdown voltage	$V_{(BR)}$	$I_T=1\text{mA}$	6.2		7.3	V
Clamping voltage	$V_C^{(2)}$	$I_{PP}=13A$			13	V
Forward voltage	V_F	$I_F=10\text{mA}$			0.9	V
Junction capacitance	C_J	$V_R=0V, f=1\text{MHz}$		95		pF

(1). Other voltages available upon request.

(2). Non-repetitive current pulse 8/20 μs exponential decay waveform

TYPICAL CHARACTERISTICS

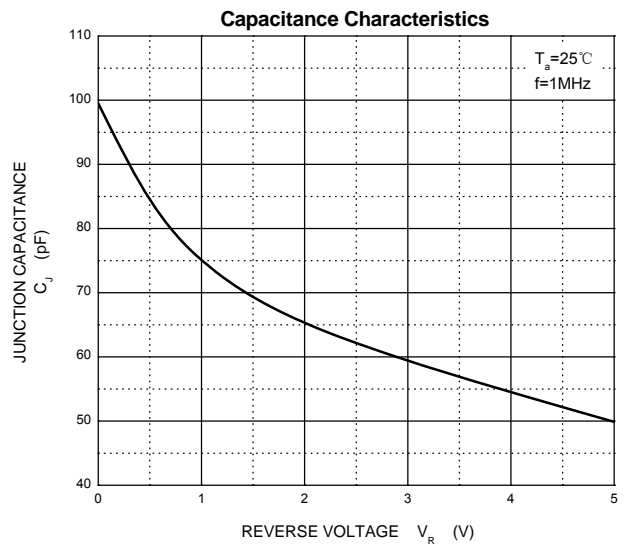
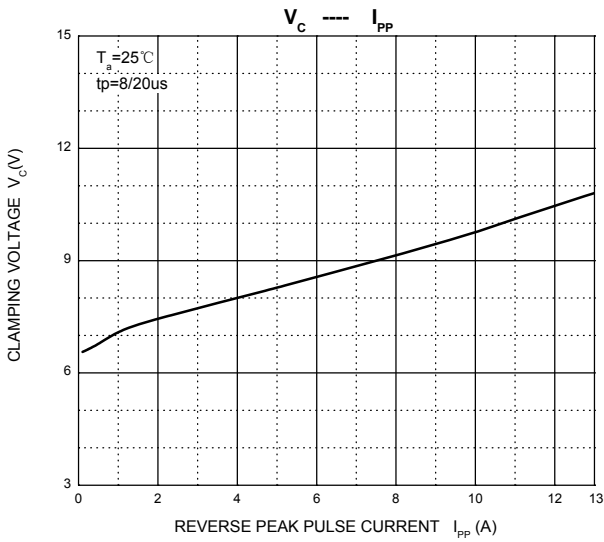
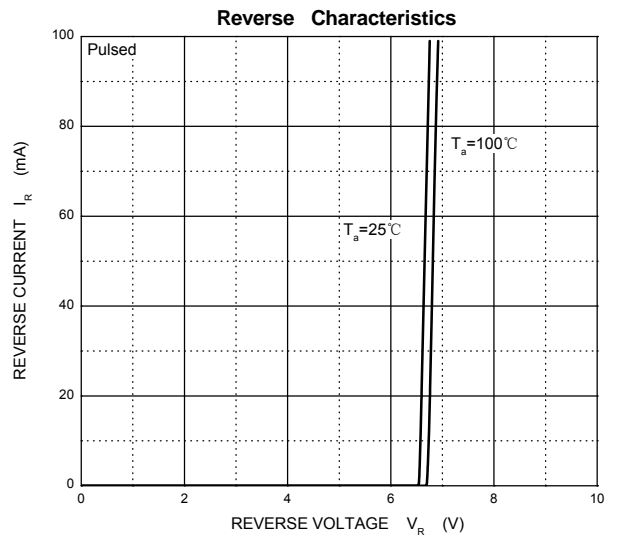
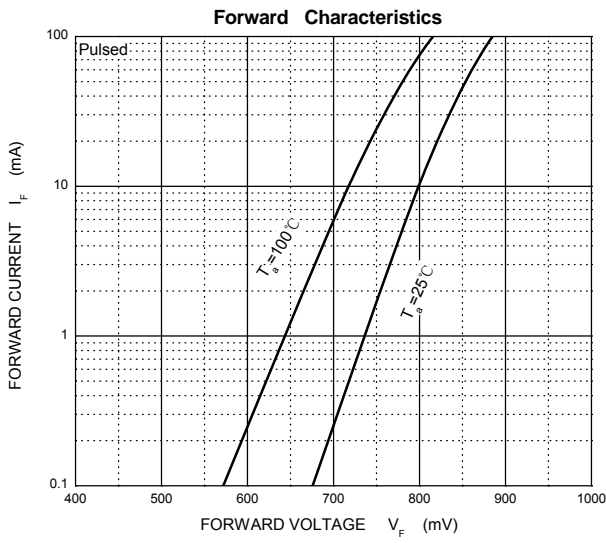

Package outline dimensions

SOD-523

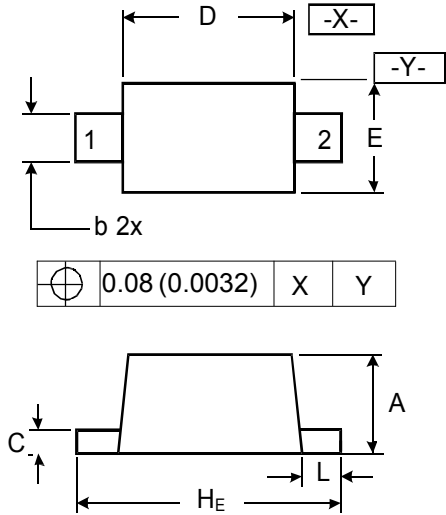

DIMENSIONS

SYMBOL	MILLIMETER		INCHES	
	MIN	MAX	MIN	MAX
A	0.50	0.70	0.020	0.028
b	0.25	0.35	0.010	0.014
C	0.07	0.20	0.0028	0.0079
D	1.10	1.30	0.043	0.051
E	0.70	0.90	0.028	0.035
H _E	1.50	1.70	0.059	0.067
L	0.15	0.25	0.006	0.010

Marking



Ordering information

Order code	Package	Baseqty	Delivery mode
UMW CESD5V0D5	SOD-523	3000	Tape and reel

X-ON Electronics

Largest Supplier of Electrical and Electronic Components

Click to view similar products for [ESD Suppressors / TVS Diodes](#) category:

Click to view products by [Youtai](#) manufacturer:

Other Similar products are found below :

[60KS200C](#) [D18V0L1B2LP-7B](#) [D5V0F4U5P5-7](#) [NTE4902](#) [P4KE27CA](#) [P6KE11CA](#) [P6KE8.2A](#) [SA60CA](#) [SA64CA](#) [SMBJ12CATR](#)
[SMBJ33CATR](#) [SMBJ6.5A](#) [SMBJ8.0A](#) [ESD101-B1-02ELS E6327](#) [ESD112-B1-02EL E6327](#) [ESD7451N2T5G](#) [19180-510](#) [CPDT-5V0USP-](#)
[HF](#) [3.0SMCJ33CA-F](#) [3.0SMCJ36A-F](#) [HSPC16701B02TP](#) [JANTX1N6126A](#) [D3V3Q1B2DLP3-7](#) [D55V0M1B2WS-7](#) [SCM1293A-04SO](#)
[ESD200-B1-CSP0201 E6327](#) [SM12-7](#) [CEN955 W/DATA](#) [VESD12A1A-HD1-GS08](#) [CPDQC5V0-HF](#) [D1213A-01LP4-7B](#) [ESD101-B1-02EL](#)
[E6327](#) [AOZ8808DI-03](#) [5KP15A](#) [5KP48A](#) [5KP90A](#) [ESD3V3D7-TP](#) [15KPA36A-LF](#) [P4KE56CA](#) [P4KE68A](#) [P4KE91CATR](#) [P6KE120A](#)
[P6KE13CA](#) [P6KE43CA](#) [P6KE6.8CA](#) [P6KE8.2](#) [P6SMBJ20CA](#) [JANTX1N6072A](#) [SR2835ESKG](#) [SA90CA](#)