

General Description

This device is well suited for Power Management and load switching applications common in Notebook Computers and Portable Battery Packs.

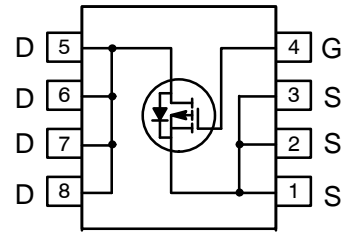

SOP-8

Features

- $V_{DS} (V) = -30V$
- $I_D = -8.8 A (V_{GS} = -10V)$
- $R_{DS(ON)} < 20m\Omega (V_{GS} = -10V)$
- $R_{DS(ON)} < 35 m\Omega (V_{GS} = -4.5V)$

MOSFET Maximum Ratings $T_A = 25^\circ C$ unless otherwise noted

Symbol	Parameter	Rated	Units
V_{DS}	Drain to Source Voltage	-30	V
V_{GS}	Gate to Source Voltage	± 25	V
I_D	Drain Current -Continuous $T_A = 25^\circ C$ (Note 1a)	-8.8	A
	-Pulsed	-50	
P_D	Power Dissipation $T_A = 25^\circ C$ (Note 1a)	2.5	W
	Power Dissipation $T_A = 25^\circ C$ (Note 1b)	1.0	
E_{AS}	Single Pulse Avalanche Energy (Note 4)	24	mJ
T_J, T_{STG}	Operating and Storage Junction Temperature Range	-55 to +150	$^\circ C$

Thermal Characteristics

$R_{\theta JC}$	Thermal Resistance, Junction to Case	25	$^\circ C/W$
$R_{\theta JA}$	Thermal Resistance, Junction to Ambient (Note 1a)	50	

Electrical Characteristics $T_J = 25^\circ\text{C}$ unless otherwise noted

Symbol	Parameter	Test Conditions	Min	Typ	Max	Units
BV_{DSS}	Drain to Source Breakdown Voltage	$I_D = -250\mu\text{A}, V_{GS} = 0\text{V}$	-30			V
$\frac{\Delta BV_{DSS}}{\Delta T_J}$	Breakdown Voltage Temperature Coefficient	$I_D = -250\mu\text{A}$, referenced to 25°C		-21		$\text{mV}/^\circ\text{C}$
I_{DSS}	Zero Gate Voltage Drain Current	$V_{DS} = -24\text{V}, V_{GS} = 0\text{V}$			1	μA
I_{GSS}	Gate to Source Leakage Current	$V_{GS} = \pm 25\text{V}, V_{DS} = 0\text{V}$			± 10	μA
$V_{GS(th)}$	Gate to Source Threshold Voltage	$V_{GS} = V_{DS}, I_D = -250\mu\text{A}$	-1	-2.1	-3	V
$\frac{\Delta V_{GS(th)}}{\Delta T_J}$	Gate to Source Threshold Voltage Temperature Coefficient	$I_D = -250\mu\text{A}$, referenced to 25°C		6		$\text{mV}/^\circ\text{C}$
$r_{DS(on)}$	Static Drain to Source On Resistance	$V_{GS} = -10\text{V}, I_D = -8.8\text{A}$ $V_{GS} = -4.5\text{V}, I_D = -6.7\text{A}$		16 26	20 35	$\text{m}\Omega$
g_{FS}	Forward Transconductance	$V_{DS} = -5\text{V}, I_D = -8.8\text{A}$		24		S
C_{iss}	Input Capacitance	$V_{DS} = -15\text{V}, V_{GS} = 0\text{V}$,		1385	1845	pF
C_{oss}	Output Capacitance	$f = 1\text{MHz}$		275	365	pF
C_{rss}	Reverse Transfer Capacitance			230	345	pF
R_g	Gate Resistance	$f = 1\text{MHz}$		4.5		Ω
$t_{d(on)}$	Turn-On Delay Time			10	20	ns
t_r	Rise Time	$V_{DD} = -15\text{V}, I_D = -8.8\text{A}$,		6	12	ns
$t_{d(off)}$	Turn-Off Delay Time	$V_{GS} = -10\text{V}, R_{GEN} = 6\Omega$		30	48	ns
t_f	Fall Time			12	22	ns
Q_g	Total Gate Charge	$V_{GS} = 0\text{V to } -10\text{V}$		28	40	nC
Q_g	Total Gate Charge	$V_{GS} = 0\text{V to } -5\text{V}$		16	23	nC
Q_{gs}	Gate to Source Charge	$V_{DD} = -15\text{V}, I_D = -8.8\text{A}$		5.2		nC
Q_{gd}	Gate to Drain "Miller" Charge			7.4		nC
V_{SD}	Source to Drain Diode Forward Voltage	$V_{GS} = 0\text{V}, I_S = -8.8\text{A}$ (Note 2)		-0.9	-1.2	V
t_{rr}	Reverse Recovery Time			29	44	ns
Q_{rr}	Reverse Recovery Charge	$I_F = -8.8\text{A}, di/dt = 100\text{A}/\mu\text{s}$		23	35	nC

NOTES:

1. $R_{\theta JA}$ is determined with the device mounted on a 1in^2 pad 2 oz copper pad on a $1.5 \times 1.5\text{in}$. board of FR-4 material. $R_{\theta JC}$ is guaranteed by design while $R_{\theta CA}$ is determined by the user's board design.



a. $50^\circ\text{C}/\text{W}$ when mounted on a 1in^2 pad of 2 oz copper.



b. $125^\circ\text{C}/\text{W}$ when mounted on a minimum pad of 2 oz copper.

2. Pulse Test: Pulse Width $< 300\mu\text{s}$, Duty cycle $< 2.0\%$.

3. The diode connected between the gate and source serves only as protection against ESD. No gate overvoltage rating is implied.

4. Starting $T_J = 25^\circ\text{C}$, $L = 1\text{mH}$, $I_{AS} = -7\text{A}$, $V_{DD} = -30\text{V}$, $V_{GS} = -10\text{V}$

Typical Characteristics $T_J = 25^\circ\text{C}$ unless otherwise noted

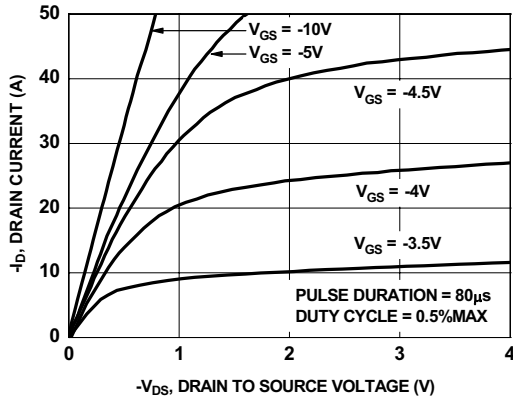

Figure 1. On-Region Characteristics

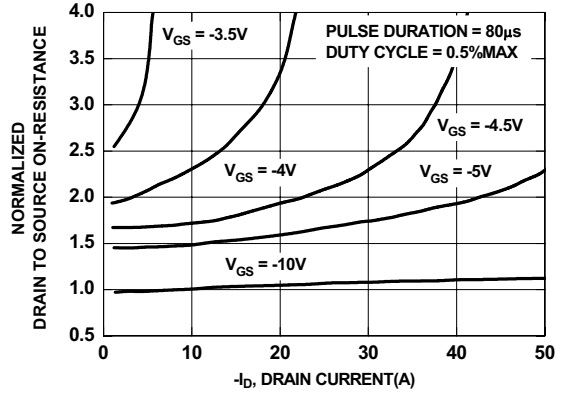

Figure 2. Normalized On-Resistance vs Drain Current and Gate Voltage

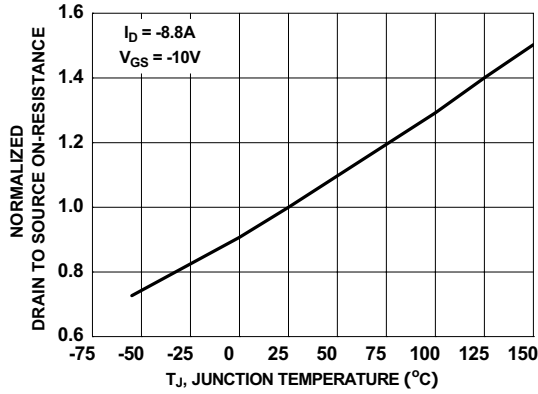

Figure 3. Normalized On-Resistance vs Junction Temperature

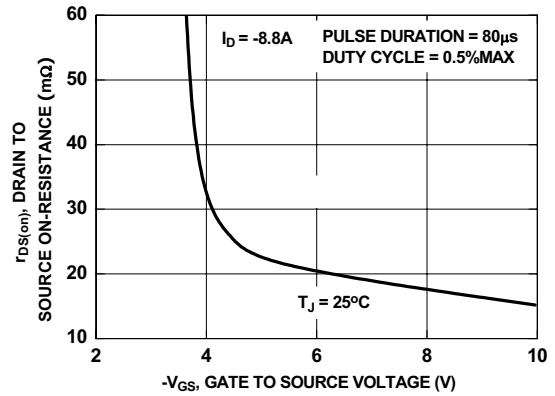

Figure 4. On-Resistance vs Gate to Source Voltage

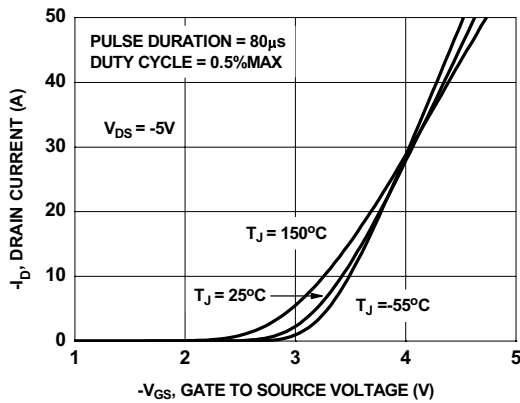

Figure 5. Transfer Characteristics

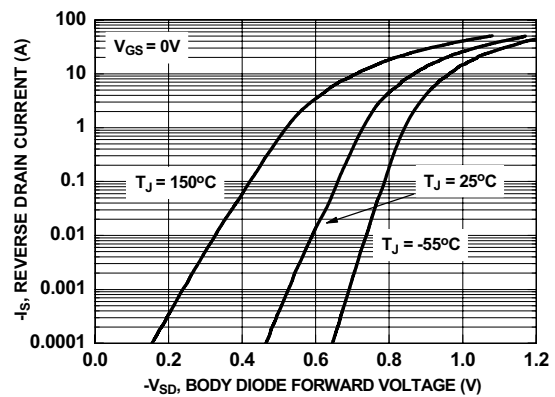

Figure 6. Source to Drain Diode Forward Voltage vs Source Current

Typical Characteristics $T_J = 25^\circ\text{C}$ unless otherwise noted

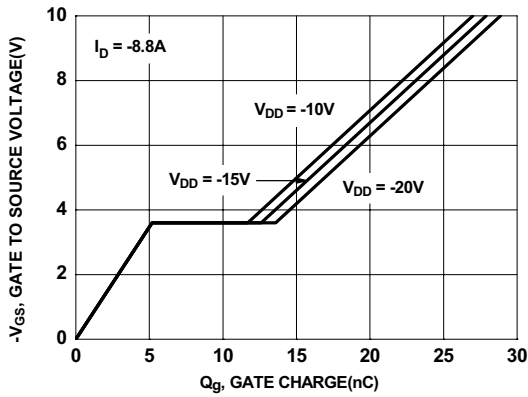

Figure 7. Gate Charge Characteristics

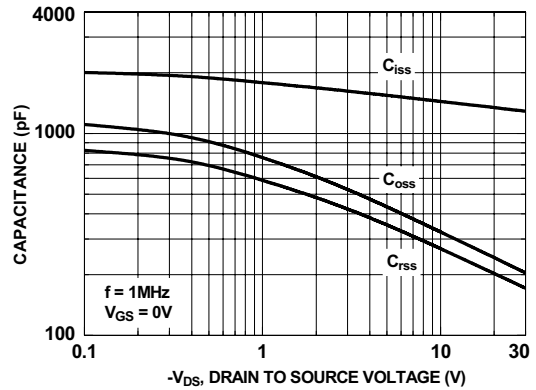

Figure 8. Capacitance vs Drain to Source Voltage

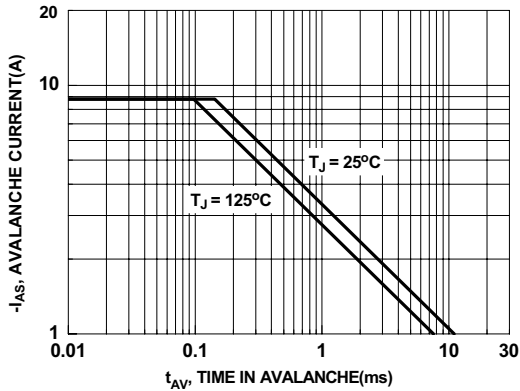

Figure 9. Unclamped Inductive Switching Capability

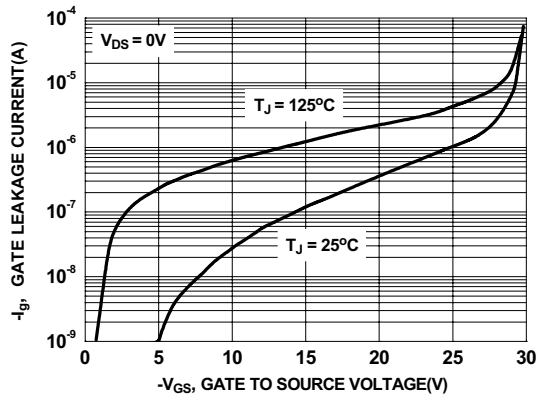

Figure 10. Gate Leakage Current vs Gate to Source Voltage

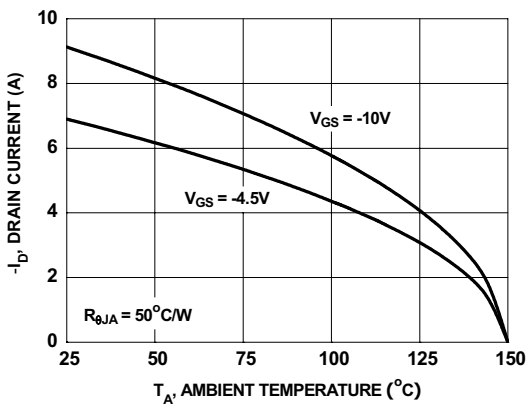

Figure 11. Maximum Continuous Drain Current vs Ambient Temperature

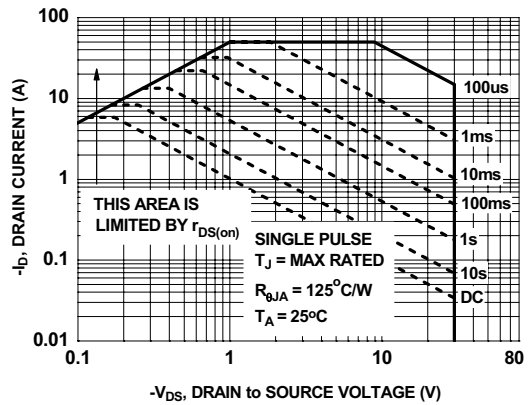

Figure 12. Forward Bias Safe Operating Area

Typical Characteristics $T_J = 25^\circ\text{C}$ unless otherwise noted

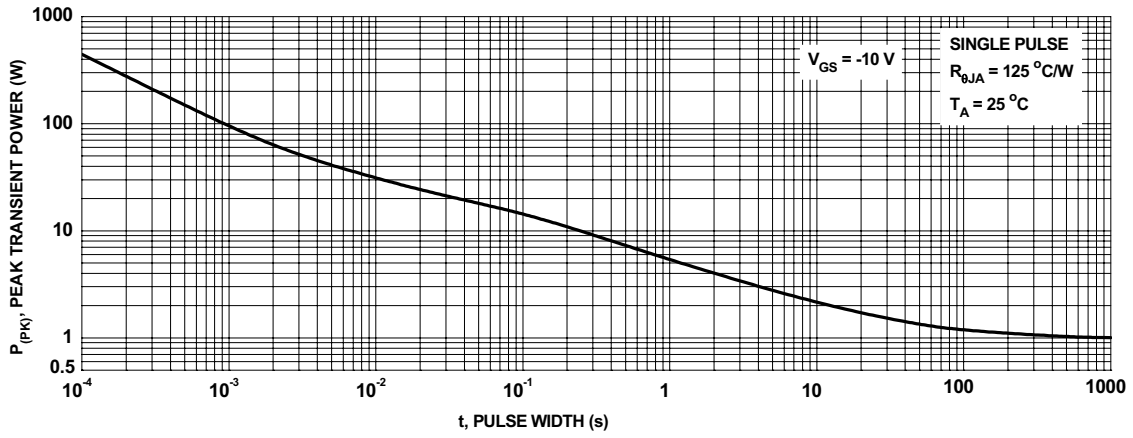

Figure 13. Single Pulse Maximum Power Dissipation

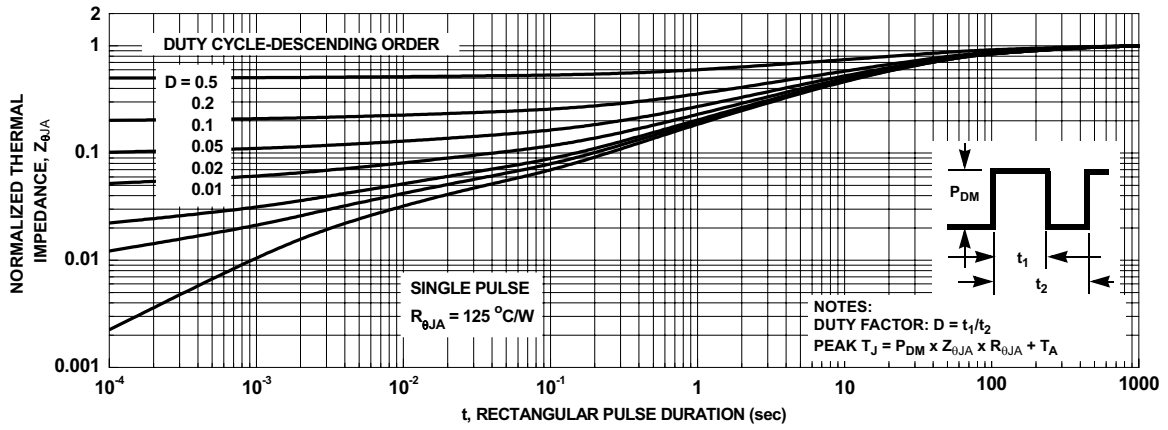
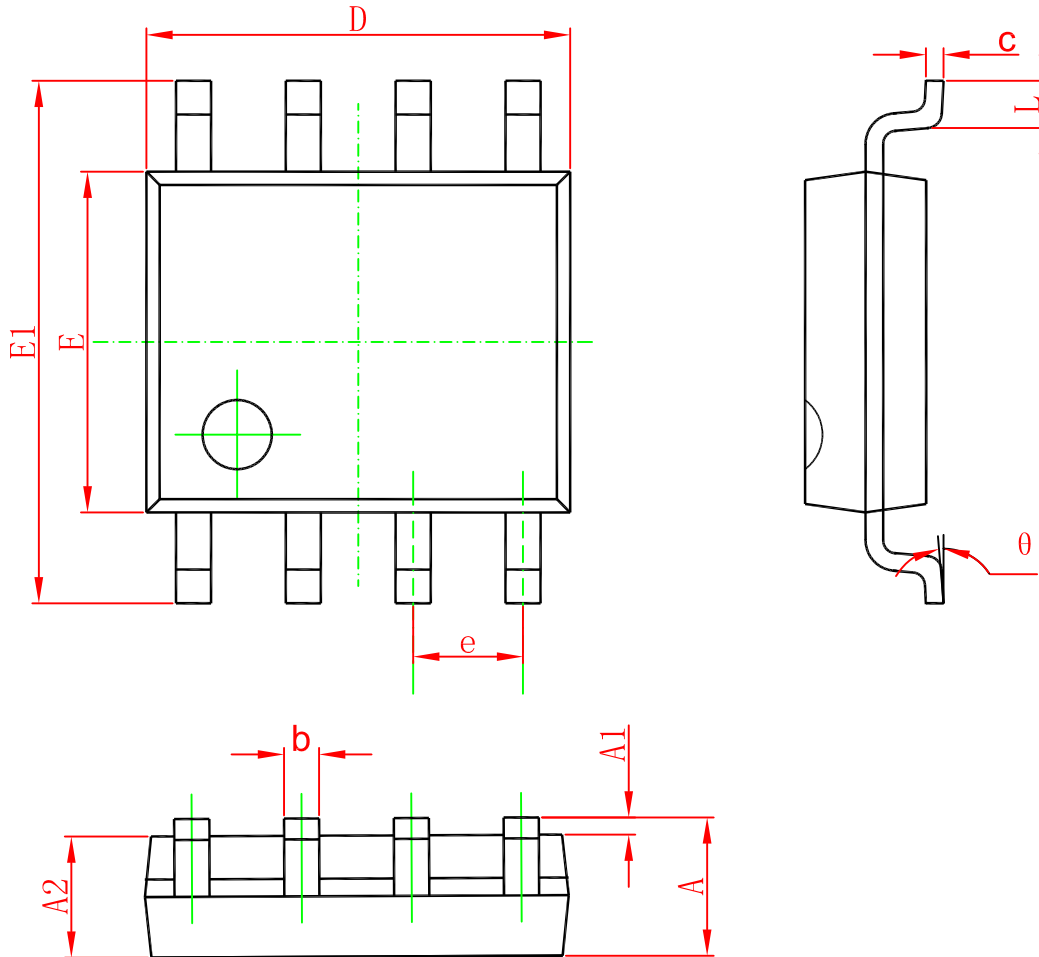

Figure 14. Transient Thermal Response Curve

Package Mechanical Data SOP-8



Symbol	Dimensions In Millimeters		Dimensions In Inches	
	Min	Max	Min	Max
A	1.350	1.750	0.053	0.069
A1	0.100	0.250	0.004	0.010
A2	1.350	1.550	0.053	0.061
b	0.330	0.510	0.013	0.020
c	0.170	0.250	0.006	0.010
D	4.700	5.100	0.185	0.200
E	3.800	4.000	0.150	0.157
E1	5.800	6.200	0.228	0.244
e	1.270(BSC)		0.050(BSC)	
L	0.400	1.270	0.016	0.050
theta	0°	8°	0°	8°

Marking

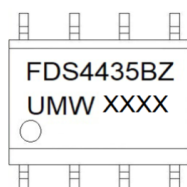

Ordering information

Order code	Package	Baseqty	Deliverymode
UMW FDS4435BZ	SOP-8	3000	Tape and reel

X-ON Electronics

Largest Supplier of Electrical and Electronic Components

Click to view similar products for [MOSFET](#) category:

Click to view products by [Youtai](#) manufacturer:

Other Similar products are found below :

[IRFD120](#) [JANTX2N5237](#) [2SK2267\(Q\)](#) [BUK455-60A/B](#) [TK100A10N1,S4X\(S](#) [MIC4420CM-TR](#) [VN1206L](#) [NDP4060](#) [SI4482DY](#)
[IRS2092STRPBF-EL](#) [IPS70R2K0CEAKMA1](#) [TK31J60W5,S1VQ\(O](#) [TK31J60W,S1VQ\(O](#) [TK16J60W,S1VQ\(O](#) [2SK2614\(TE16L1,Q\)](#)
[DMN1017UCP3-7](#) [EFC2J004NUZTDG](#) [P85W28HP2F-7071](#) [DMN1053UCP4-7](#) [NTE2384](#) [DMC2700UDMQ-7](#) [DMN2080UCB4-7](#)
[DMN61D9UWQ-13](#) [US6M2GTR](#) [DMN31D5UDJ-7](#) [DMP22D4UFO-7B](#) [IPS60R3K4CEAKMA1](#) [DMN1006UCA6-7](#) [DMN16M9UCA6-7](#)
[STF5N65M6](#) [IRF40H233XTMA1](#) [STU5N65M6](#) [DMN6022SSD-13](#) [DMN13M9UCA6-7](#) [DMTH10H4M6SPS-13](#) [IPS60R360PFD7SAKMA1](#)
[DMN2990UFB-7B](#) [SSM3K35CT,L3F](#) [IPLK60R1K0PFD7ATMA1](#) [2N7002W-G](#) [MCAC30N06Y-TP](#) [IPWS65R035CFD7AXKSA1](#)
[MCQ7328-TP](#) [SSM3J143TU,LXHF](#) [PJMF280N65E1_T0_00201](#) [PJMF380N65E1_T0_00201](#) [PJMF280N60E1_T0_00201](#)
[PJMF600N65E1_T0_00201](#) [PJMF900N65E1_T0_00201](#) [PJMF900N60E1_T0_00201](#)