

General Description

This advanced MOSFET technology has been especially tailored to reduce on-state resistance, and to provide superior switching performance and high avalanche energy strength. These devices are suitable for switched mode power supplies, audio amplifier, DC motor control, and variable switching power applications.

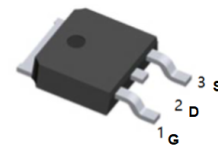
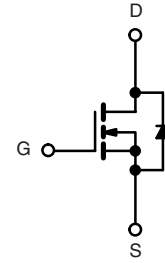

TO-252(DPAK) top view

V_{DS}	60V
I_D (at $V_{GS}=10V$)	30A
$R_{DS(ON)}$ (at $V_{GS}=10V$)	< 25mΩ
$R_{DS(ON)}$ (at $V_{GS} = 4.5V$)	< 30mΩ

ABSOLUTE MAXIMUM RATINGS $T_C = 25\text{ }^\circ\text{C}$, unless otherwise noted				
Parameter		Symbol	Limit	Unit
Gate-Source Voltage		V_{GS}	± 20	V
Continuous Drain Current ($T_J = 175\text{ }^\circ\text{C}$) ^a	$T_C = 25\text{ }^\circ\text{C}$	I_D	35	A
	$T_C = 100\text{ }^\circ\text{C}$		28	
Pulsed Drain Current		I_{DM}	100	
Continuous Source Current (Diode Conduction)		I_S	23	
Avalanche Current		I_{AS}	20	
Single Avalanche Energy (Duty Cycle $\leq 1\%$)	$L = 0.1\text{ mH}$	E_{AS}	20	mJ
Maximum Power Dissipation	$T_C = 25\text{ }^\circ\text{C}$	P_D	100	W
	$T_A = 25\text{ }^\circ\text{C}$		3	
Operating Junction and Storage Temperature Range		T_J, T_{stg}	- 55 to 175	$^\circ\text{C}$

THERMAL RESISTANCE RATINGS					
Parameter		Symbol	Typical	Maximum	Unit
Maximum Junction-to-Ambient	$t \leq 10\text{ sec}$	R_{thJA}	18	22	$^\circ\text{C/W}$
	Steady State		40	50	
Maximum Junction-to-Case		R_{thJC}	3.2	4	

SPECIFICATIONS $T_J = 25\text{ }^\circ\text{C}$, unless otherwise noted						
Parameter	Symbol	Test Conditions	Min	Typ	Max	Unit
Static						
Drain-Source Breakdown Voltage	$V_{(BR)DSS}$	$V_{GS} = 0\text{ V}, I_D = 250\text{ }\mu\text{A}$	60			V
Gate Threshold Voltage	$V_{GS(th)}$	$V_{DS} = V_{GS}, I_D = 250\text{ }\mu\text{A}$	1.0	2.0	3.0	
Gate-Body Leakage	I_{GSS}	$V_{DS} = 0\text{ V}, V_{GS} = \pm 20\text{ V}$			± 100	nA
Zero Gate Voltage Drain Current	I_{DSS}	$V_{DS} = 60\text{ V}, V_{GS} = 0\text{ V}$			1	μA
		$V_{DS} = 60\text{ V}, V_{GS} = 0\text{ V}, T_J = 125\text{ }^\circ\text{C}$			50	
		$V_{DS} = 60\text{ V}, V_{GS} = 0\text{ V}, T_J = 175\text{ }^\circ\text{C}$			250	
On-State Drain Current ^a	$I_{D(on)}$	$V_{DS} = 5\text{ V}, V_{GS} = 10\text{ V}$	50			A
Drain-Source On-State Resistance ^a	$r_{DS(on)}$	$V_{GS} = 10\text{ V}, I_D = 15\text{ A}$		25	31	$\text{m}\Omega$
		$V_{GS} = 10\text{ V}, I_D = 15\text{ A}, T_J = 125\text{ }^\circ\text{C}$			55	
		$V_{GS} = 10\text{ V}, I_D = 15\text{ A}, T_J = 175\text{ }^\circ\text{C}$			69	
		$V_{GS} = 4.5\text{ V}, I_D = 10\text{ A}$		30	45	
Forward Transconductance ^a	g_{fs}	$V_{DS} = 15\text{ V}, I_D = 15\text{ A}$		20		S
Dynamic						
Input Capacitance	C_{iss}	$V_{GS} = 0\text{ V}, V_{DS} = 25\text{ V}, f = 1\text{ MHz}$		670		pF
Output Capacitance	C_{oss}			140		
Reverse Transfer Capacitance	C_{rss}			60		
Total Gate Charge ^b	Q_g	$V_{DS} = 30\text{ V}, V_{GS} = 10\text{ V}, I_D = 23\text{ A}$		11	17	nC
Gate-Source Charge ^b	Q_{gs}			3		
Gate-Drain Charge ^b	Q_{gd}			3		
Turn-On Delay Time ^b	$t_{d(on)}$	$V_{DD} = 30\text{ V}, R_L = 1.3\text{ }\Omega$ $I_D \cong 23\text{ A}, V_{GEN} = 10\text{ V}, R_g = 2.5\text{ }\Omega$		8	15	ns
Rise Time ^b	t_r			15	25	
Turn-Off Delay Time ^b	$t_{d(off)}$			30	45	
Fall Time ^b	t_f			25	40	
Source-Drain Diode Ratings and Characteristics ($T_C = 25\text{ }^\circ\text{C}$)						
Pulsed Current	I_{SM}				50	A
Diode Forward Voltage	V_{SD}	$I_F = 15\text{ A}, V_{GS} = 0\text{ V}$		1.0	1.5	V
Reverse Recovery Time	t_{rr}	$I_F = 15\text{ A}, di/dt = 100\text{ A}/\mu\text{s}$		30	60	ns

- a. Pulse test; pulse width $\leq 300\text{ }\mu\text{s}$, duty cycle $\leq 2\%$.
b. Independent of operating temperature.

TYPICAL CHARACTERISTICS 25 °C unless noted

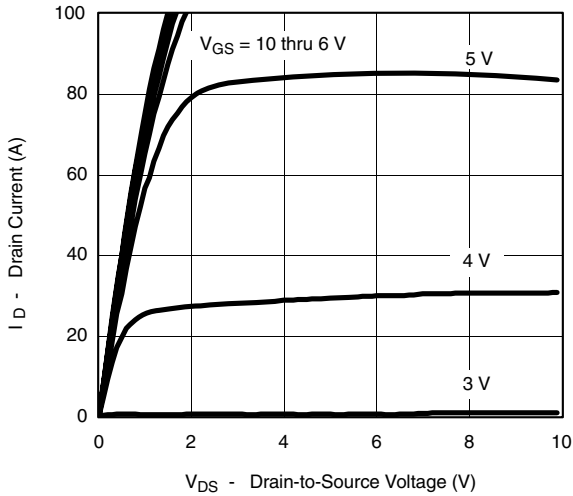

Output Characteristics

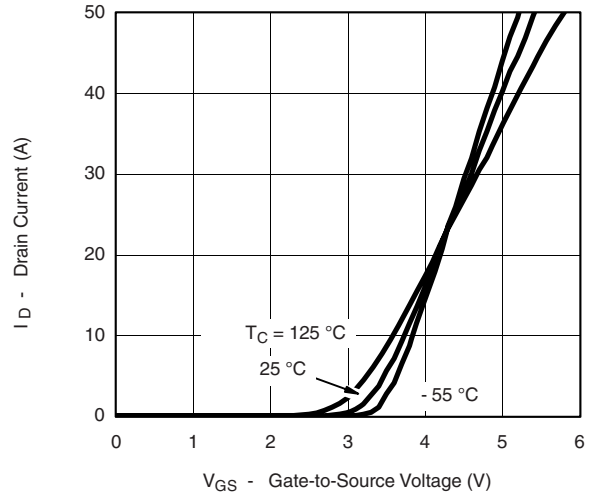

Transfer Characteristics



Transconductance



On-Resistance vs. Drain Current



Capacitance

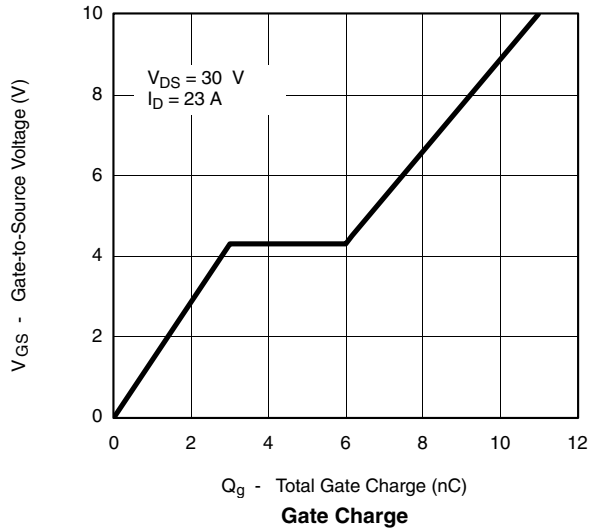

Gate Charge

TYPICAL CHARACTERISTICS 25 °C unless noted

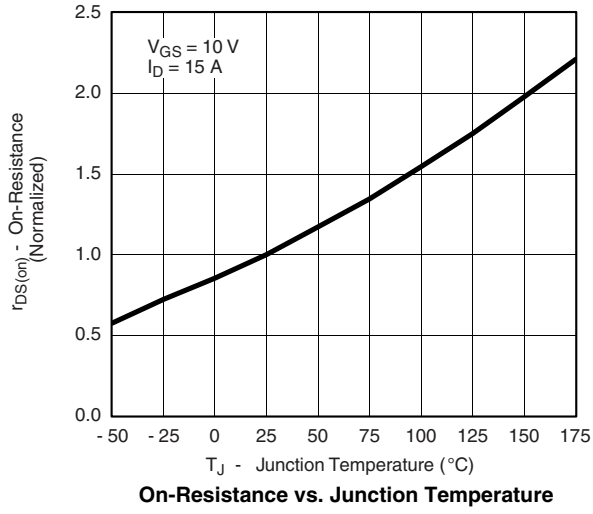

THERMAL RATINGS



TA - Ambient Temperature (°C)
Maximum Drain Current vs. Ambient Temperature

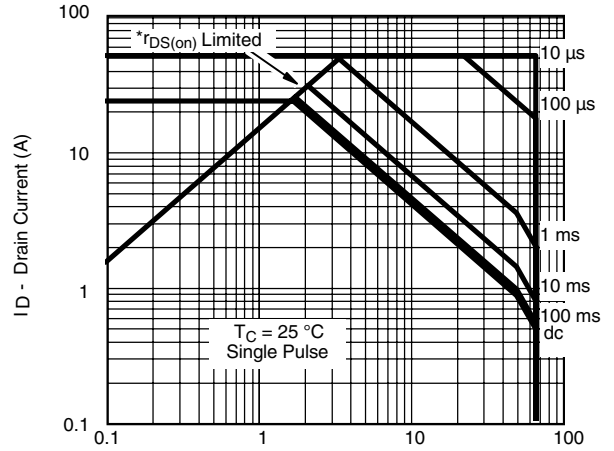

V_{DS} - Drain-to-Source Voltage (V)
*V_{GS} > minimum V_{GS} at which r_{DS(on)} is specified
Safe Operating Area



Normalized Thermal Transient Impedance, Junction-to-Case

Package Mechanical Data TO-252

60V N-Channel MOSFET

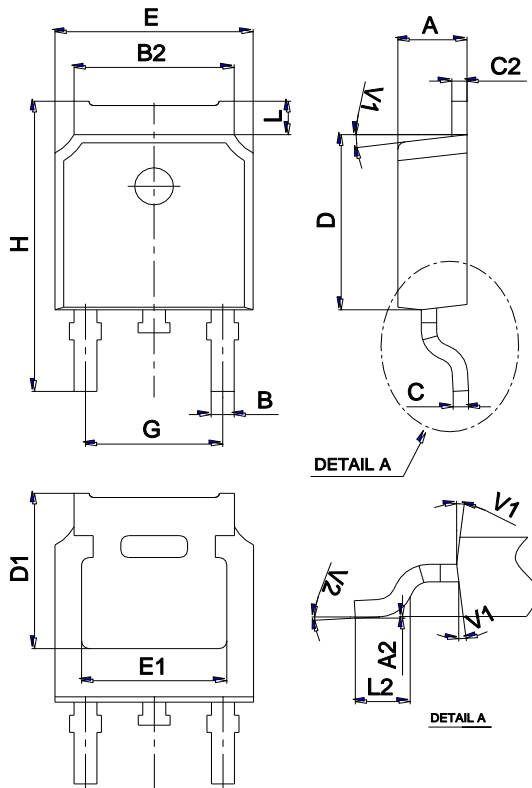

Ref.	Dimensions					
	Millimeters			Inches		
	Min.	Typ.	Max.	Min.	Typ.	Max.
A	2.10		2.50	0.083		0.098
A2	0		0.10	0		0.004
B	0.66		0.86	0.026		0.034
B2	5.18		5.48	0.202		0.216
C	0.40		0.60	0.016		0.024
C2	0.44		0.58	0.017		0.023
D	5.90		6.30	0.232		0.248
D1	5.30REF			0.209REF		
E	6.40		6.80	0.252		0.268
E1	4.63			0.182		
G	4.47		4.67	0.176		0.184
H	9.50		10.70	0.374		0.421
L	1.09		1.21	0.043		0.048
L2	1.35		1.65	0.053		0.065
V1		7°			7°	
V2		0°	6°	0°		6°

Ordering information

Order code	Package	Baseqty	Delivery mode
UMW FQD20N06	TO-252	2500	Tape and reel

X-ON Electronics

Largest Supplier of Electrical and Electronic Components

Click to view similar products for [MOSFET](#) category:

Click to view products by [Youtai](#) manufacturer:

Other Similar products are found below :

[IRFD120](#) [JANTX2N5237](#) [2SK2267\(Q\)](#) [BUK455-60A/B](#) [TK100A10N1,S4X\(S](#) [MIC4420CM-TR](#) [VN1206L](#) [NDP4060](#) [SI4482DY](#)
[IRS2092STRPBF-EL](#) [IPS70R2K0CEAKMA1](#) [TK31J60W5,S1VQ\(O](#) [TK31J60W,S1VQ\(O](#) [TK16J60W,S1VQ\(O](#) [2SK2614\(TE16L1,Q\)](#)
[DMN1017UCP3-7](#) [EFC2J004NUZTDG](#) [P85W28HP2F-7071](#) [DMN1053UCP4-7](#) [NTE2384](#) [DMC2700UDMQ-7](#) [DMN2080UCB4-7](#)
[DMN61D9UWQ-13](#) [US6M2GTR](#) [DMN31D5UDJ-7](#) [DMP22D4UFO-7B](#) [IPS60R3K4CEAKMA1](#) [DMN1006UCA6-7](#) [DMN16M9UCA6-7](#)
[STF5N65M6](#) [IRF40H233XTMA1](#) [STU5N65M6](#) [DMN6022SSD-13](#) [DMN13M9UCA6-7](#) [DMTH10H4M6SPS-13](#) [IPS60R360PFD7SAKMA1](#)
[DMN2990UFB-7B](#) [SSM3K35CT,L3F](#) [IPLK60R1K0PFD7ATMA1](#) [2N7002W-G](#) [MCAC30N06Y-TP](#) [IPWS65R035CFD7AXKSA1](#)
[MCQ7328-TP](#) [SSM3J143TU,LXHF](#) [PJMF280N65E1_T0_00201](#) [PJMF380N65E1_T0_00201](#) [PJMF280N60E1_T0_00201](#)
[PJMF600N65E1_T0_00201](#) [PJMF900N65E1_T0_00201](#) [PJMF900N60E1_T0_00201](#)