

### Description

Features of this design are a 150°C junction operating temperature, fast switching speed and improved repetitive avalanche rating. These features combine to make this design an extremely efficient and reliable device for use in a wide variety of other applications.

### Features

- $V_{DS} (V) = -60V$
- $I_D = -42A (V_{GS} = -10V)$
- $R_{DS(ON)} < 20m\Omega (V_{GS} = -10V)$
- Ultra Low On-Resistance
- 150°C Operating Temperature
- Fast Switching

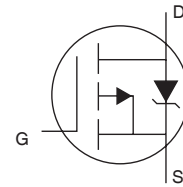
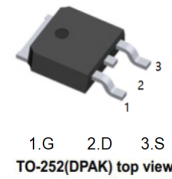

### Absolute Maximum Ratings

	Parameter	Max.	Units
$I_D @ T_C = 25^\circ C$	Continuous Drain Current, $V_{GS} @ 10V$ (Silicon Limited)	-70	A
$I_D @ T_C = 100^\circ C$	Continuous Drain Current, $V_{GS} @ 10V$ (Silicon Limited)	-44	
$I_D @ T_C = 25^\circ C$	Continuous Drain Current, $V_{GS} @ 10V$ (Package Limited)	-42	
$I_{DM}$	Pulsed Drain Current <sup>1</sup> .	-280	
$P_D @ T_C = 25^\circ C$	Power Dissipation	170	W
	Linear Derating Factor	1.3	W/°C
$V_{GS}$	Gate-to-Source Voltage	$\pm 20$	V
$E_{AS}$ (Thermally limited)	Single Pulse Avalanche Energy <sup>2</sup> .	140	mJ
$E_{AS}$ (Tested)	Single Pulse Avalanche Energy Tested Value <sup>6</sup> .	790	
$I_{AR}$	Avalanche Current <sup>1</sup> .	See Fig.12a, 12b, 15, 16	A
$E_{AR}$	Repetitive Avalanche Energy <sup>5</sup> .		mJ
$T_J$	Operating Junction and	-55 to + 150	°C
$T_{STG}$	Storage Temperature Range		
	Soldering Temperature, for 10 seconds	300 (1.6mm from case)	
	Mounting Torque, 6-32 or M3 screw <sup>7</sup> .	10 lbf•in (1.1N•m)	

### Thermal Resistance

	Parameter	Typ.	Max.	Units
$R_{\theta JC}$	Junction-to-Case <sup>8</sup> .		0.75	
$R_{\theta JA}$	Junction-to-Ambient (PCB Mount, steady state) <sup>7,8</sup> .		40	

**Electrical Characteristics @  $T_J = 25^\circ\text{C}$  (unless otherwise specified)**

	Parameter	Min.	Typ.	Max.	Units	Conditions
$V_{(BR)DSS}$	Drain-to-Source Breakdown Voltage	-55			V	$V_{GS} = 0V, I_D = -250\mu A$
$\Delta V_{(BR)DSS}/\Delta T_J$	Breakdown Voltage Temp. Coefficient		-0.054		V/ $^\circ\text{C}$	Reference to $25^\circ\text{C}, I_D = -1\text{mA}$
$R_{DS(on)}$	Static Drain-to-Source On-Resistance			20	m $\Omega$	$V_{GS} = -10V, I_D = -42A^3$
$V_{GS(th)}$	Gate Threshold Voltage	-1.1	-1.8	-2.5	V	$V_{DS} = V_{GS}, I_D = -250\mu A$
gfs	Forward Transconductance		19		S	$V_{DS} = -25V, I_D = -42A$
$I_{DSS}$	Drain-to-Source Leakage Current			-25	$\mu A$	$V_{DS} = -55V, V_{GS} = 0V$
				-200		$V_{DS} = -44V, V_{GS} = 0V, T_J = 125^\circ\text{C}$
$I_{GSS}$	Gate-to-Source Forward Leakage			100	nA	$V_{GS} = -20V$
	Gate-to-Source Reverse Leakage			-100		$V_{GS} = 20V$
$Q_g$	Total Gate Charge		120	180		$I_D = -42A$
$Q_{gs}$	Gate-to-Source Charge		32		nC	$V_{DS} = -44V$
$Q_{gd}$	Gate-to-Drain ("Miller") Charge		53			$V_{GS} = -10V^3$
$t_{d(on)}$	Turn-On Delay Time		20			$V_{DD} = -28V$
$t_r$	Rise Time		99			$I_D = -42A$
$t_{d(off)}$	Turn-Off Delay Time		51		ns	$R_G = 2.6 \Omega$
$t_f$	Fall Time		64			$V_{GS} = -10V^3$
$L_S$	Internal Source Inductance		7.5		nH	Between lead, and center of die contact
$C_{iss}$	Input Capacitance		3500			$V_{GS} = 0V$
$C_{oss}$	Output Capacitance		1250			$V_{DS} = -25V$
$C_{rss}$	Reverse Transfer Capacitance		450		pF	$f = 1.0\text{MHz}$
$C_{oss}$	Output Capacitance		4620			$V_{GS} = 0V, V_{DS} = -1.0V, f = 1.0\text{MHz}$
$C_{oss}$	Output Capacitance		940			$V_{GS} = 0V, V_{DS} = -44V, f = 1.0\text{MHz}$
$C_{oss \text{ eff.}}$	Effective Output Capacitance		1530			$V_{GS} = 0V, V_{DS} = 0V \text{ to } -44V^4$

**Source-Drain Ratings and Characteristics**

	Parameter	Min.	Typ.	Max.	Units	Conditions
$I_S$	Continuous Source Current (Body Diode)		-42		A	MOSFET symbol showing the integral reverse
$I_{SM}$	Pulsed Source Current (Body Diode) <sup>1</sup>			-280		p-n junction diode.
$V_{SD}$	Diode Forward Voltage			-1.3	V	$T_J = 25^\circ\text{C}, I_S = -42A, V_{GS} = 0V^3$
$t_{rr}$	Reverse Recovery Time		61	92	ns	$T_J = 25^\circ\text{C}, I_F = -42A, V_{DD} = -28V$
$Q_{rr}$	Reverse Recovery Charge		150	220	nC	$di/dt = -100A/\mu s^3$
$t_{on}$	Forward Turn-On Time	Intrinsic turn-on time is negligible (turn-on is dominated by LS+LD)				

**Notes:**

1. Repetitive rating; pulse width limited by max. junction temperature.
2. Limited by  $T_{Jmax}$ , starting  $T_J = 25^\circ\text{C}$ ,  $L = 0.16\text{mH}$ ,  $R_G = 25\Omega$ ,  $I_{AS} = -42A$ ,  $V_{GS} = -10V$ . Part not recommended for use above this value.
3. Pulse width  $\leq 1.0\text{ms}$ ; duty cycle  $\leq 2\%$ .
4.  $C_{oss \text{ eff.}}$  is a fixed capacitance that gives the same charging time as  $C_{oss}$  while  $V_{DS}$  is rising from 0 to 80%  $V_{DSS}$ .
5. Limited by  $T_{Jmax}$ , see Fig.12a, 12b, 15, 16 for typical repetitive avalanche performance.
6. This value determined from sample failure population. 100% tested to this value in production.
7. This is applied to D<sup>2</sup>Pak, when mounted on 1" square PCB (FR-4 or G-10 Material).
8.  $R_{\theta}$  is measured at  $T_J$  approximately  $90^\circ\text{C}$

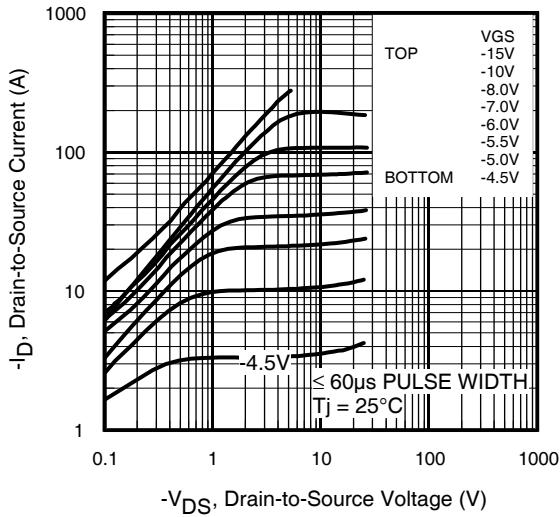

Fig 1. Typical Output Characteristics

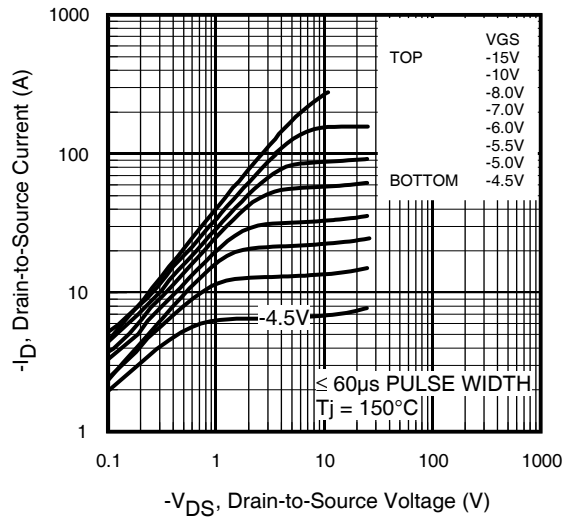

Fig 2. Typical Output Characteristics

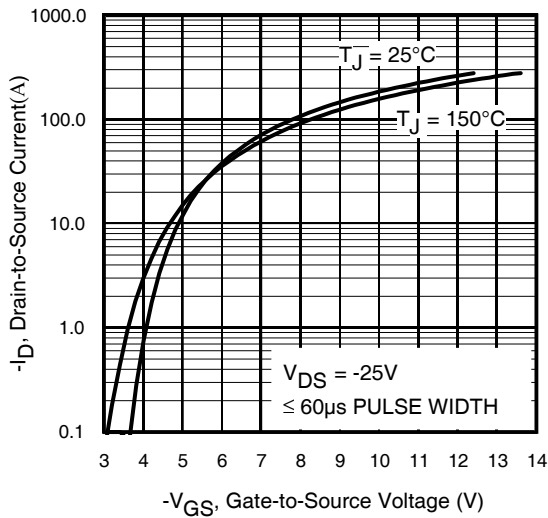

Fig 3. Typical Transfer Characteristics

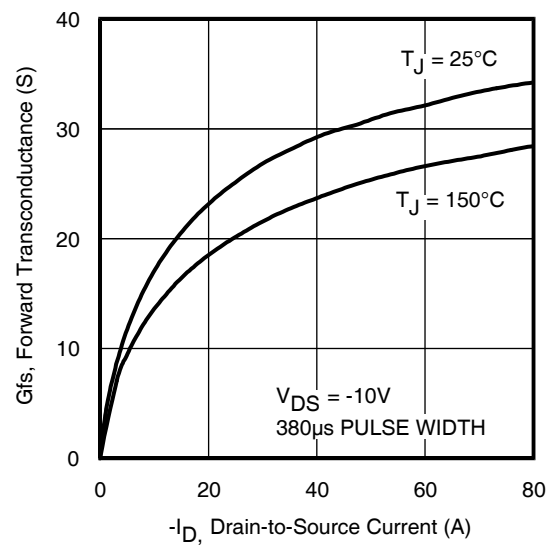

Fig 4. Typical Forward Transconductance Vs. Drain Current

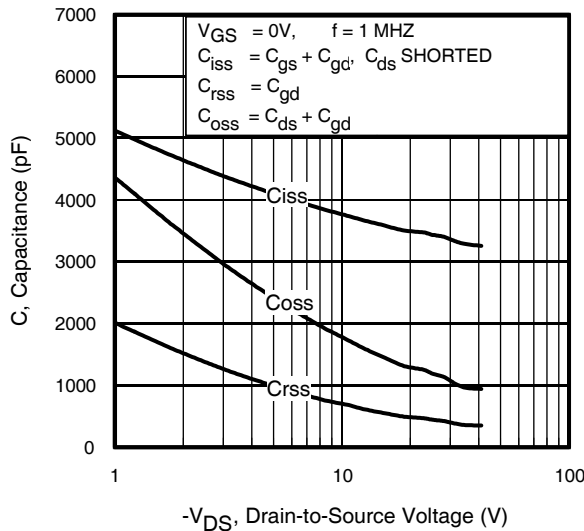

Fig 5. Typical Capacitance Vs. Drain-to-Source Voltage

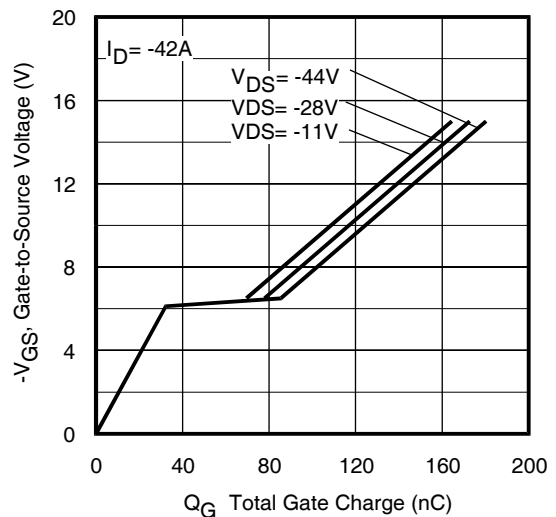

Fig 6. Typical Gate Charge Vs. Gate-to-Source Voltage

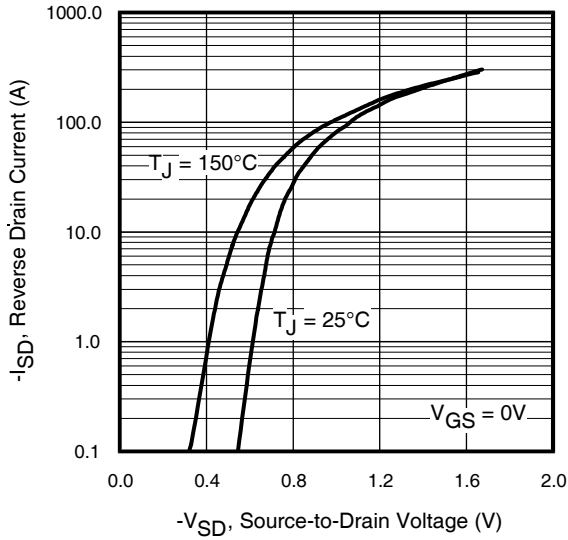

Fig 7. Typical Source-Drain Diode Forward Voltage

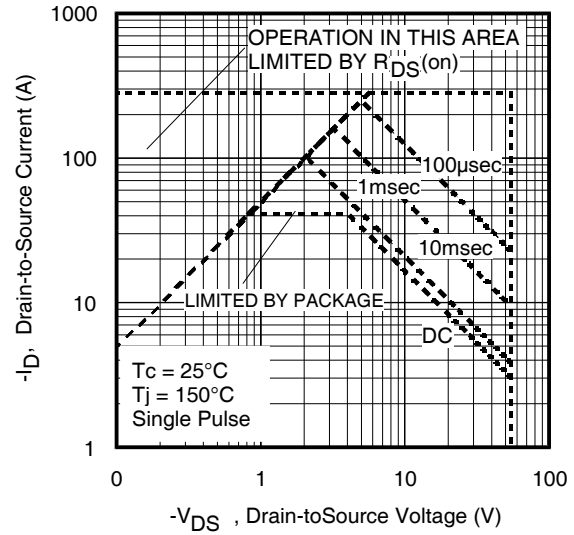

Fig 8. Maximum Safe Operating Area

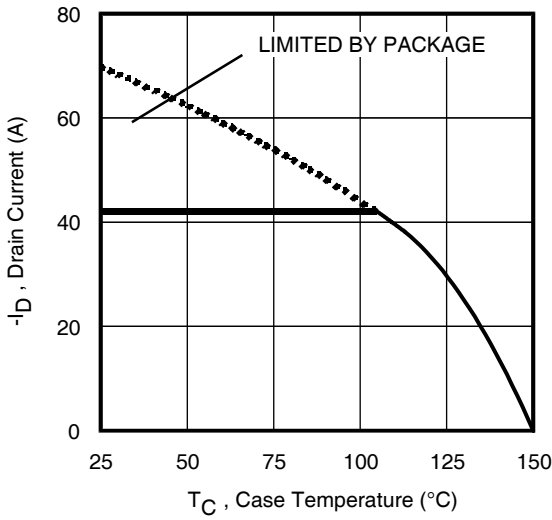

Fig 9. Maximum Drain Current Vs. Case Temperature

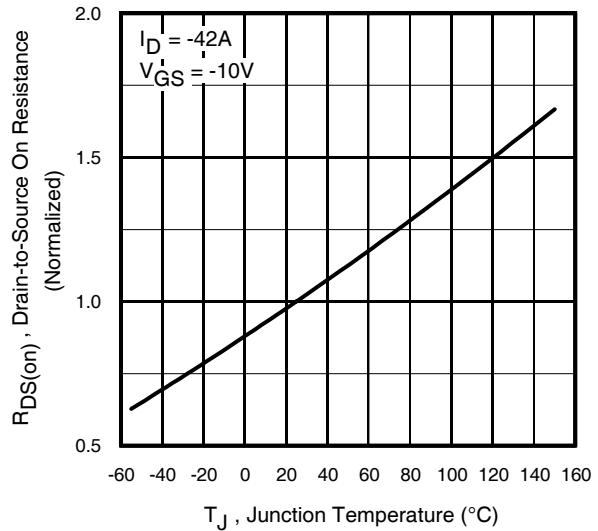

Fig 10. Normalized On-Resistance Vs. Temperature

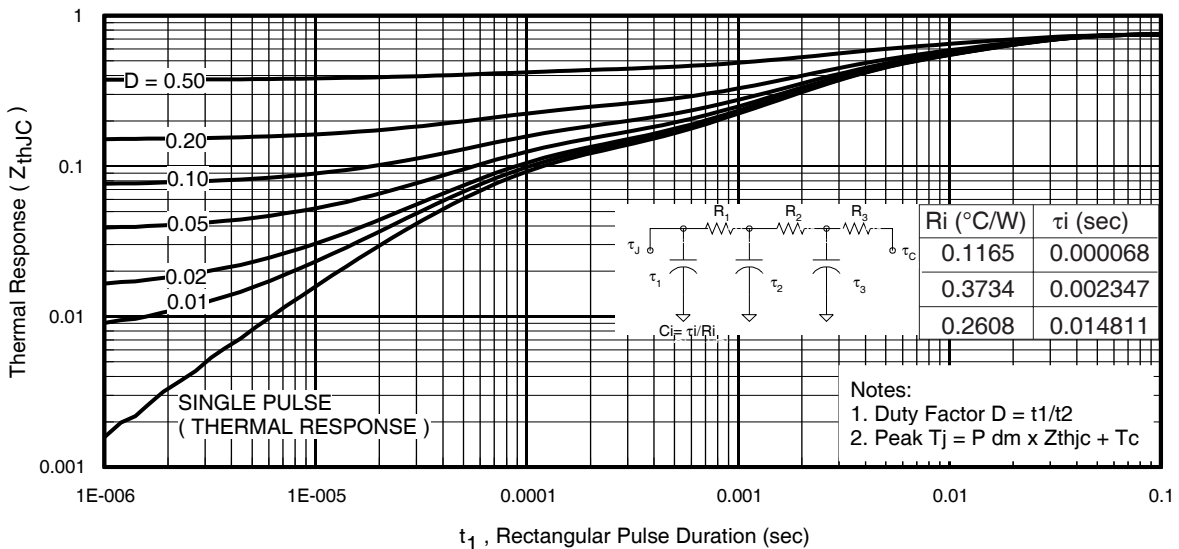

Fig 11. Maximum Effective Transient Thermal Impedance, Junction-to-Case

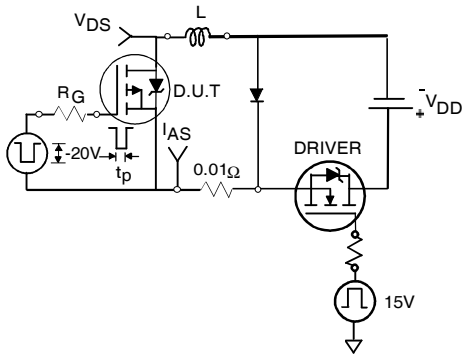

Fig 12a. Unclamped Inductive Test Circuit

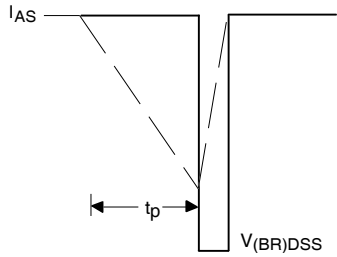

Fig 12b. Unclamped Inductive Waveforms

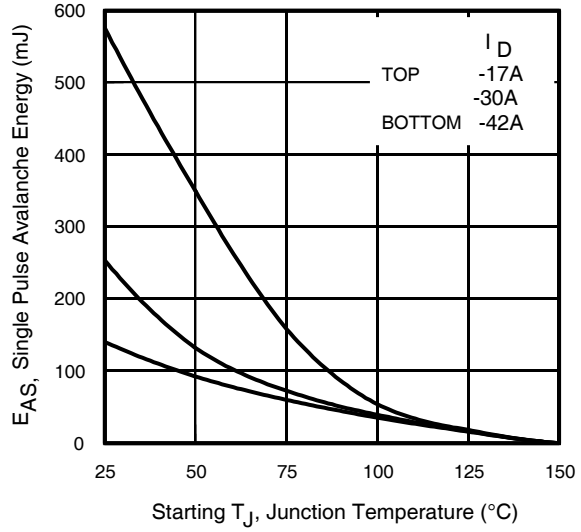

Fig 12c. Maximum Avalanche Energy Vs. Drain Current

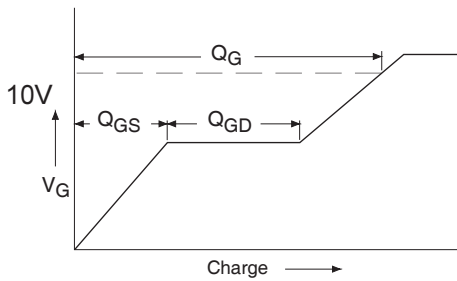

Fig 13a. Basic Gate Charge Waveform

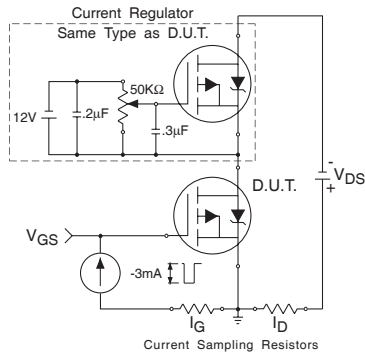

Fig 13b. Gate Charge Test Circuit

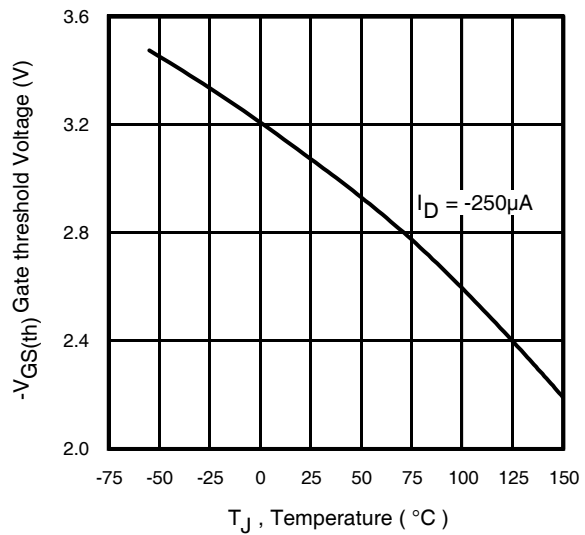

Fig 14. Threshold Voltage Vs. Temperature

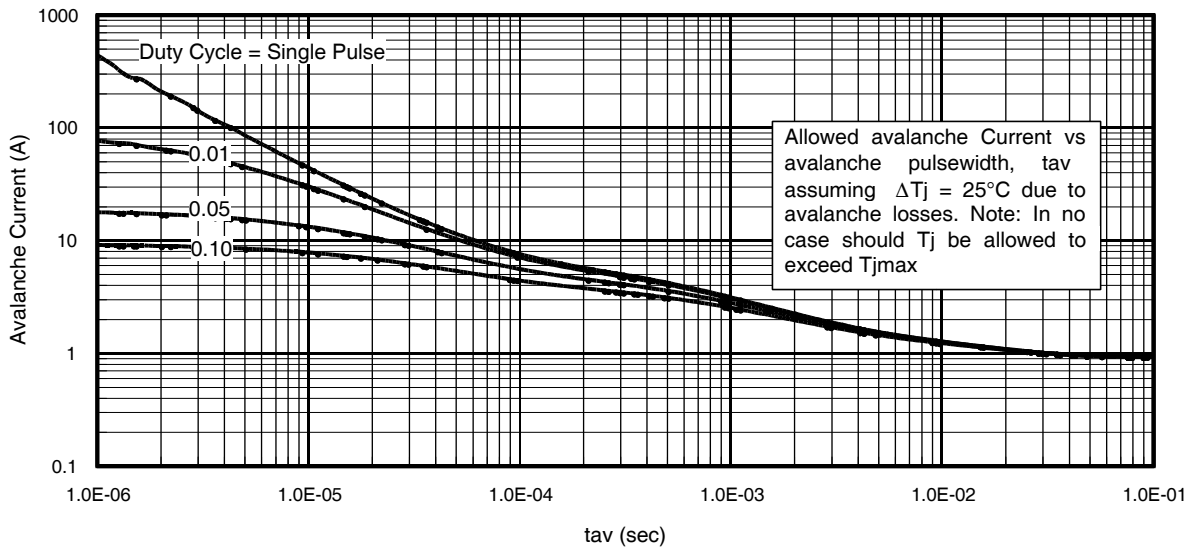

Fig 15. Typical Avalanche Current Vs.Pulsewidth

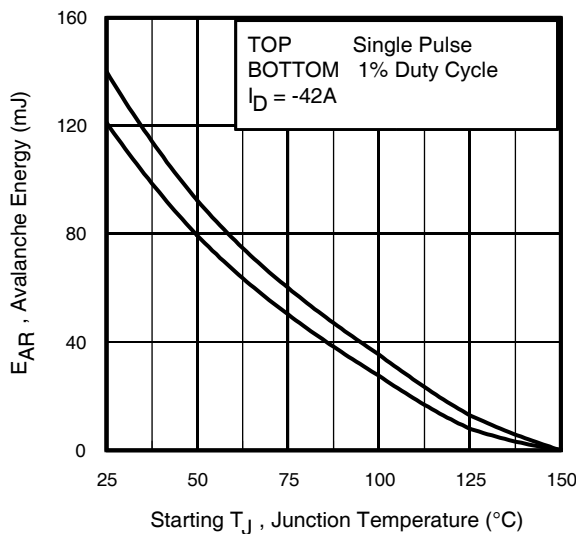

Fig 16. Maximum Avalanche Energy Vs. Temperature

Notes on Repetitive Avalanche Curves , Figures 15, 16:

1. Avalanche failures assumption:  
Purely a thermal phenomenon and failure occurs at a temperature far in excess of  $T_{jmax}$ . This is validated for every part type.
2. Safe operation in Avalanche is allowed as long as  $T_{jmax}$  is not exceeded.
3. Equation below based on circuit and waveforms shown in Figures 12a, 12b.
4.  $P_{D(ave)}$  = Average power dissipation per single avalanche pulse.
5.  $BV$  = Rated breakdown voltage (1.3 factor accounts for voltage increase during avalanche).
6.  $I_{av}$  = Allowable avalanche current.
7.  $\Delta T$  = Allowable rise in junction temperature, not to exceed  $T_{jmax}$  (assumed as 25°C in Figure 15, 16).  
 $t_{av}$  = Average time in avalanche.  
 $D$  = Duty cycle in avalanche =  $t_{av} \cdot f$   
 $Z_{thJC}(D, t_{av})$  = Transient thermal resistance)

$$P_{D(ave)} = 1/2 ( 1.3 \cdot BV \cdot I_{av} ) = \Delta T / Z_{thJC}$$

$$I_{av} = 2\Delta T / [1.3 \cdot BV \cdot Z_{th}]$$

$$E_{AS(AR)} = P_{D(ave)} \cdot t_{av}$$

Package Mechanical Data TO-263

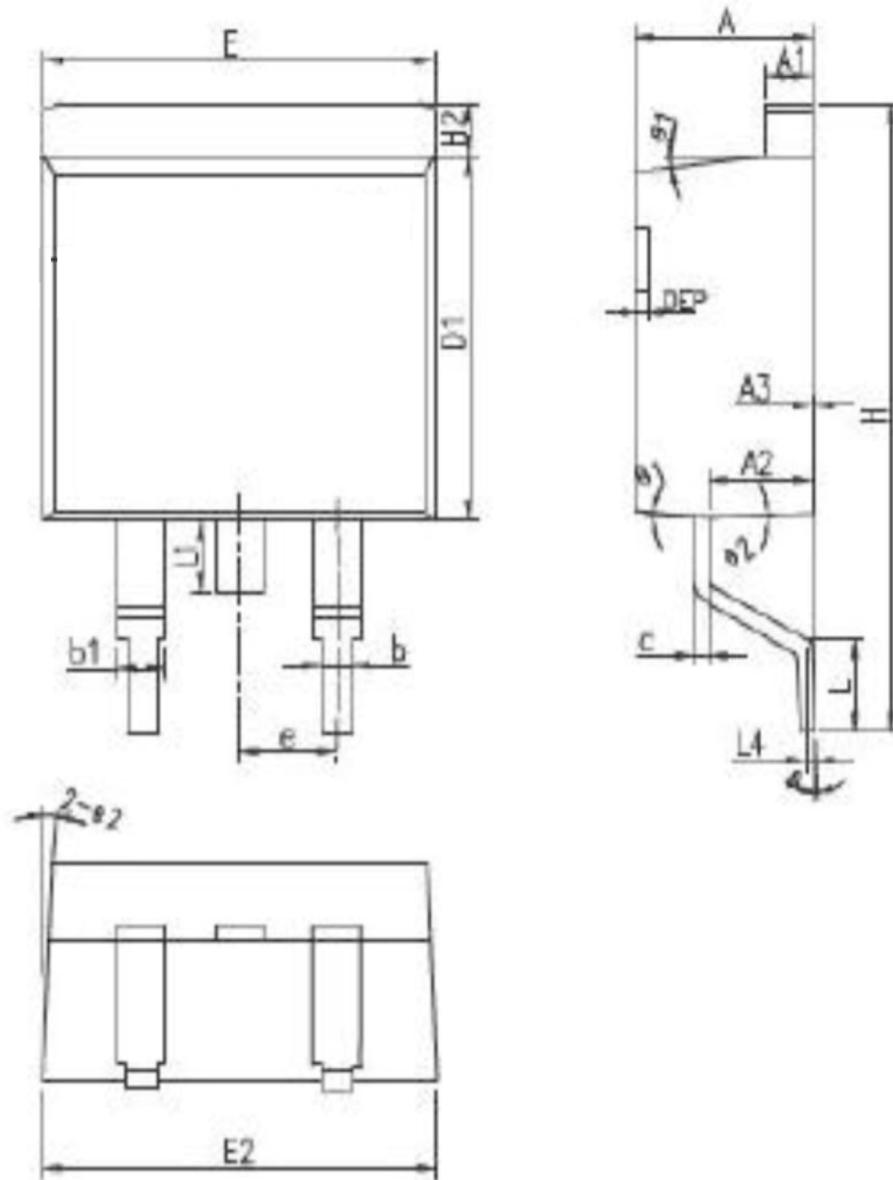

Symbol	Inches			Millimeters		
	Min	Nom	Max	Min	Nom	Max
A	4.40	4.57	4.57	0.173	0.180	0.185
A1	1.22	1.27	1.27	0.048	0.050	0.052
A2	2.59	2.69	2.69	0.102	0.106	0.110
A3	0.00	0.10	0.10	0.000	0.004	0.008
b	0.77	0.813	0.813	0.030	0.032	0.035
b1	1.20	1.270	1.270	0.047	0.050	0.054
c	0.34	0.381	0.381	0.013	0.015	0.019
D1	8.60	8.70	8.99	0.339	0.343	0.354
E	10.00	10.16	10.16	0.394	0.400	0.404
E2	10.00	10.10	10.10	0.394	0.398	0.402
e	2.54BSC			0.100BSC		
H	14.70	15.10	15.50	0.579	0.594	0.610
H2	1.17	1.27	1.40	0.046	0.050	0.055
L	2.00	2.30	2.60	0.079	0.091	0.102
L1	1.45	1.55	1.70	0.057	0.061	0.067
L4	0.25BSC			0.010BSC		
θ	0°	5°	8°	0°	5°	8°
θ1	5°	7°	9°	5°	7°	9°
θ2	1°	3°	5°	1°	3°	5°
DEP	0.05	0.10	0.20	0.002	0.004	0.008

Package Mechanical Data TO-220

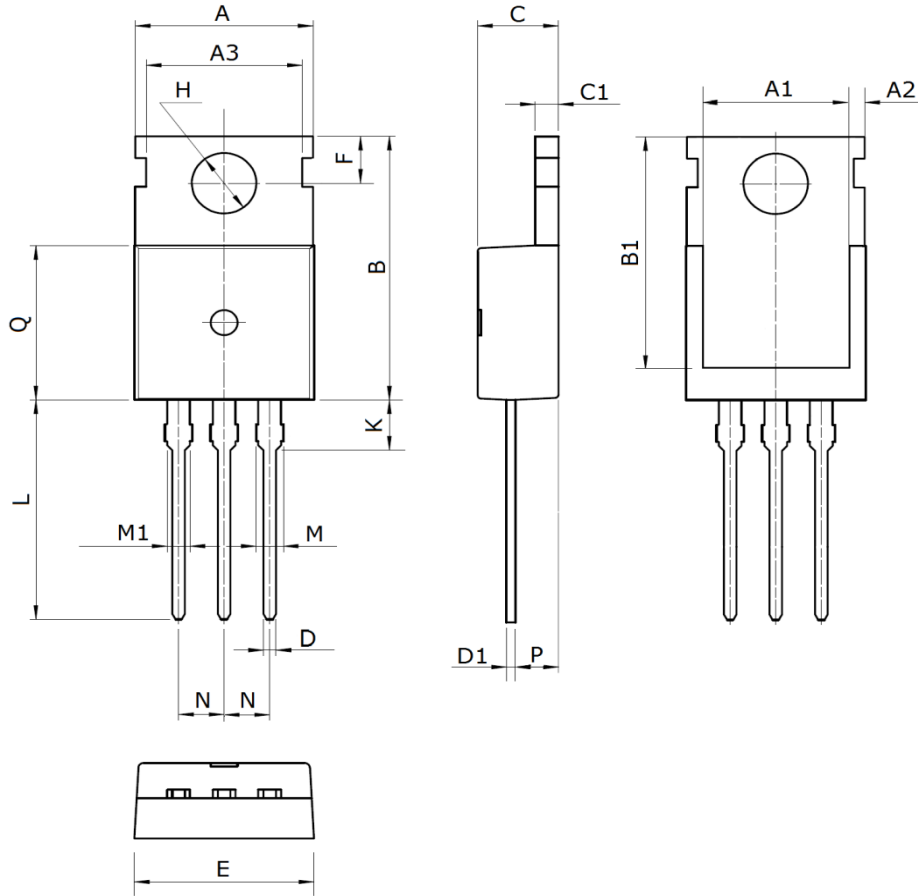



Package Mechanical Data TO-252

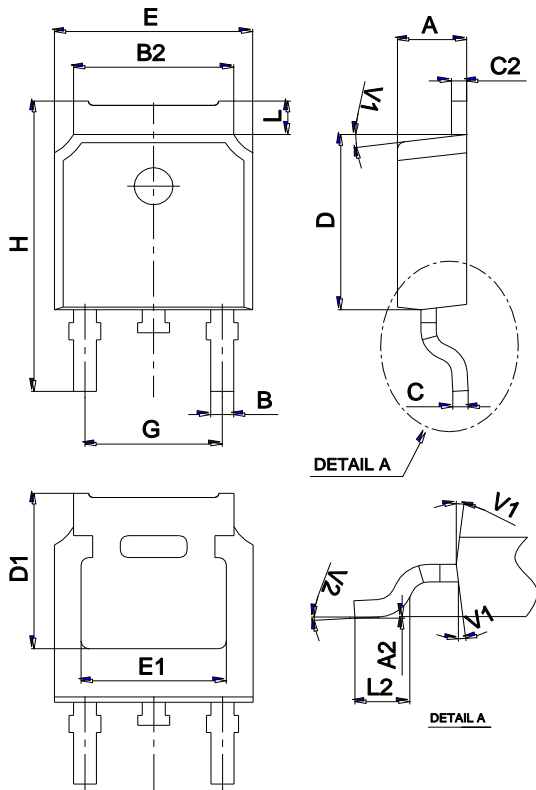

Ref.	Dimensions					
	Millimeters			Inches		
	Min.	Typ.	Max.	Min.	Typ.	Max.
A	2.10		2.50	0.083		0.098
A2	0		0.10	0		0.004
B	0.66		0.86	0.026		0.034
B2	5.18		5.48	0.202		0.216
C	0.40		0.60	0.016		0.024
C2	0.44		0.58	0.017		0.023
D	5.90		6.30	0.232		0.248
D1	5.30REF			0.209REF		
E	6.40		6.80	0.252		0.268
E1	4.63			0.182		
G	4.47		4.67	0.176		0.184
H	9.50		10.70	0.374		0.421
L	1.09		1.21	0.043		0.048
L2	1.35		1.65	0.053		0.065
V1		7°			7°	
V2	0°		6°	0°		6°

Ordering information

Order code	Package	Baseqty	Deliverymode
UMW IRF4905STRL	TO-252	2500	Tape and reel
UMW IRF4905STRLP	TO-263	800	Tape and reel
UMW IRF4905	TO-220	1000	Tube and Box

## X-ON Electronics

Largest Supplier of Electrical and Electronic Components

*Click to view similar products for [MOSFET](#) category:*

*Click to view products by [Youtai](#) manufacturer:*

Other Similar products are found below :

[IRFD120](#) [JANTX2N5237](#) [2SK2267\(Q\)](#) [BUK455-60A/B](#) [TK100A10N1,S4X\(S](#) [MIC4420CM-TR](#) [VN1206L](#) [NDP4060](#) [SI4482DY](#)  
[IRS2092STRPBF-EL](#) [IPS70R2K0CEAKMA1](#) [TK31J60W5,S1VQ\(O](#) [TK31J60W,S1VQ\(O](#) [TK16J60W,S1VQ\(O](#) [2SK2614\(TE16L1,Q\)](#)  
[DMN1017UCP3-7](#) [EFC2J004NUZTDG](#) [P85W28HP2F-7071](#) [DMN1053UCP4-7](#) [NTE2384](#) [DMC2700UDMQ-7](#) [DMN2080UCB4-7](#)  
[DMN61D9UWQ-13](#) [US6M2GTR](#) [DMN31D5UDJ-7](#) [DMP22D4UFO-7B](#) [IPS60R3K4CEAKMA1](#) [DMN1006UCA6-7](#) [DMN16M9UCA6-7](#)  
[STF5N65M6](#) [IRF40H233XTMA1](#) [STU5N65M6](#) [DMN6022SSD-13](#) [DMN13M9UCA6-7](#) [DMTH10H4M6SPS-13](#) [IPS60R360PFD7SAKMA1](#)  
[DMN2990UFB-7B](#) [SSM3K35CT,L3F](#) [IPLK60R1K0PFD7ATMA1](#) [2N7002W-G](#) [MCAC30N06Y-TP](#) [IPWS65R035CFD7AXKSA1](#)  
[MCQ7328-TP](#) [SSM3J143TU,LXHF](#) [DMN12M3UCA6-7](#) [PJMF280N65E1\\_T0\\_00201](#) [PJMF380N65E1\\_T0\\_00201](#)  
[PJMF280N60E1\\_T0\\_00201](#) [PJMF600N65E1\\_T0\\_00201](#) [PJMF900N65E1\\_T0\\_00201](#)