

Applications

- Charge and Discharge Switch for Notebook PC Battery Application

Features

- $V_{DS} (V) = -30V$
- $I_D = -12 A (V_{GS} = -10V)$
- $R_{DS(ON)} < 11.9m\Omega (V_{GS} = -10V)$
- $R_{DS(ON)} < 19.7 m\Omega (V_{GS} = -4.5V)$

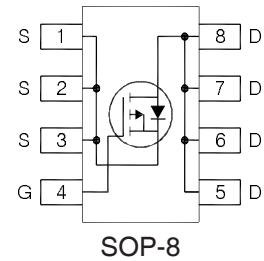

Absolute Maximum Ratings

	Parameter	Max.	Units
V_{DS}	Drain-to-Source Voltage	-30	V
V_{GS}	Gate-to-Source Voltage	± 20	
$I_D @ T_A = 25^\circ C$	Continuous Drain Current, $V_{GS} @ 10V$	-12	A
$I_D @ T_A = 70^\circ C$	Continuous Drain Current, $V_{GS} @ 10V$	-9.6	
I_{DM}	Pulsed Drain Current ①	-96	
$P_D @ T_A = 25^\circ C$	Power Dissipation ②	2.5	W
$P_D @ T_A = 70^\circ C$	Power Dissipation ②	1.6	
	Linear Derating Factor	0.02	W/°C
T_J	Operating Junction and	-55 to + 150	°C
T_{STG}	Storage Temperature Range		

Static @ T_J= 25°C (unless otherwise specified)

	Parameter	Min.	Typ.	Max.	Units	Conditions
BV _{DSS}	Drain-to-Source Breakdown Voltage	-30			V	V _{GS} = 0V, I _D = -250μA
ΔBV _{DSS} /ΔT _J	Breakdown Voltage Temp. Coefficient		0.021		V/°C	Reference to 25°C, I _D = -1mA
R _{DS(on)}	Static Drain-to-Source On-Resistance		10	11.9	mΩ	V _{GS} = -10V, I _D = -12A ③
			16.1	19.7		V _{GS} = -4.5V, I _D = -9.6A ③
V _{GS(th)}	Gate Threshold Voltage	-1.0	-1.5	-2.0	V	V _{DS} = V _{GS} , I _D = -25μA
ΔV _{GS(th)}	Gate Threshold Voltage Coefficient		-5.8		mV/°C	
I _{DSS}	Drain-to-Source Leakage Current			-1.0	μA	V _{DS} = -24V, V _{GS} = 0V
				-150		V _{DS} = -24V, V _{GS} = 0V, T _J = 125°C
I _{GSS}	Gate-to-Source Forward Leakage			-100	nA	V _{GS} = -20V
	Gate-to-Source Reverse Leakage			100		V _{GS} = 20V
g _{fs}	Forward Transconductance	20			S	V _{DS} = -10V, I _D = -9.6A
Q _g	Total Gate Charge ⑥		18		nC	V _{DS} = -15V, V _{GS} = -4.5V, I _D = -9.6A
Q _{gs}	Gate-to-Source Charge ⑥		5.3		nC	V _{GS} = -10V
Q _{gd}	Gate-to-Drain Charge ⑥		8.5			V _{DS} = -15V I _D = -9.6A
R _G	Gate Resistance ⑥		15		Ω	
t _{d(on)}	Turn-On Delay Time		19		ns	V _{DD} = -15V, V _{GS} = -4.5V ③
t _r	Rise Time		57			I _D = -1.0A
t _{d(off)}	Turn-Off Delay Time		80			R _G = 6.8Ω
t _f	Fall Time		66			See Figs. 20a & 20b
C _{iss}	Input Capacitance		1680		pF	V _{GS} = 0V
C _{oss}	Output Capacitance		350			V _{DS} = -25V
C _{rss}	Reverse Transfer Capacitance		220			f = 1.0kHz

Avalanche Characteristics

	Parameter	Typ.	Max.	Units
E _{AS}	Single Pulse Avalanche Energy ②		120	mJ
I _{AR}	Avalanche Current ①		-9.6	A

Diode Characteristics

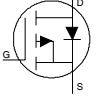
	Parameter	Min.	Typ.	Max.	Units	Conditions
I _S	Continuous Source Current (Body Diode)			-2.5	A	MOSFET symbol showing the integral reverse p-n junction diode. 
I _{SM}	Pulsed Source Current (Body Diode) ①			-96		
V _{SD}	Diode Forward Voltage			-1.2	V	T _J = 25°C, I _S = -2.5A, V _{GS} = 0V ③
t _{rr}	Reverse Recovery Time		51	76	ns	T _J = 25°C, I _F = -2.5A, V _{DD} = -24V
Q _{rr}	Reverse Recovery Charge		35	53	nC	di/dt = 100A/μs ③

Thermal Resistance

	Parameter	Typ.	Max.	Units
R _{θJL}	Junction-to-Drain Lead ⑤		20	°C/W
R _{θJA}	Junction-to-Ambient ④		50	

Notes:

- ① Repetitive rating; pulse width limited by max. junction temperature.
- ② Starting T_J = 25°C, L = 2.6mH, R_G = 25Ω, I_{AS} = -9.6A.
- ③ Pulse width ≤ 400μs; duty cycle ≤ 2%.
- ④ When mounted on 1 inch square copper board.
- ⑤ R_θ is measured at T_J of approximately 90°C.
- ⑥ For DESIGN AID ONLY, not subject to production testing.

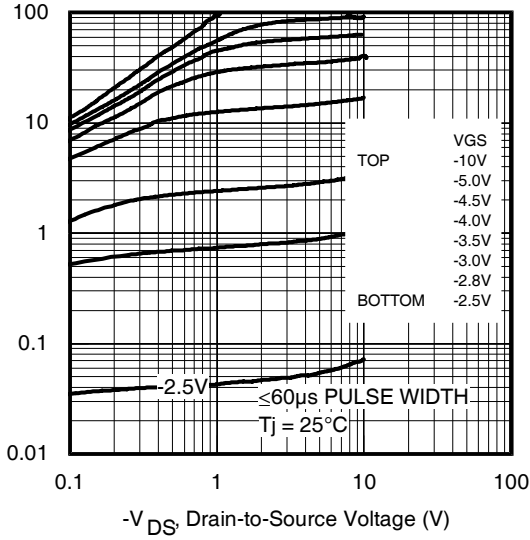

Fig 1. Typical Output Characteristics

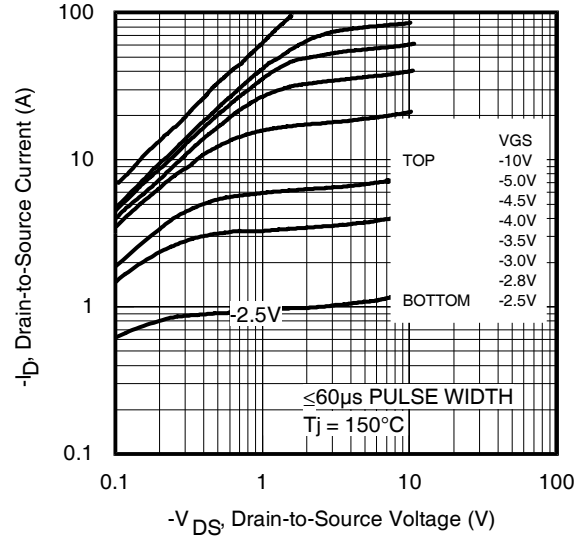

Fig 2. Typical Output Characteristics

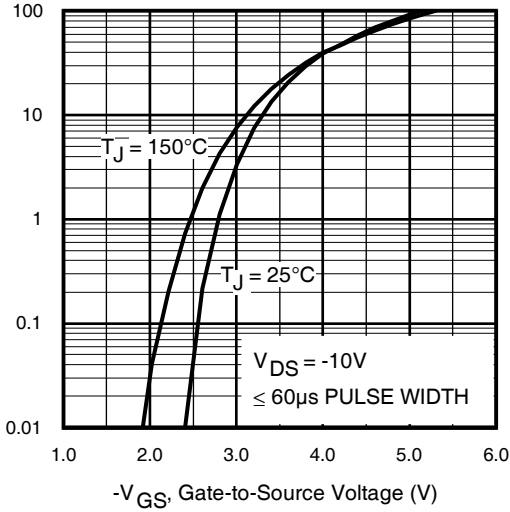

Fig 3. Typical Transfer Characteristics

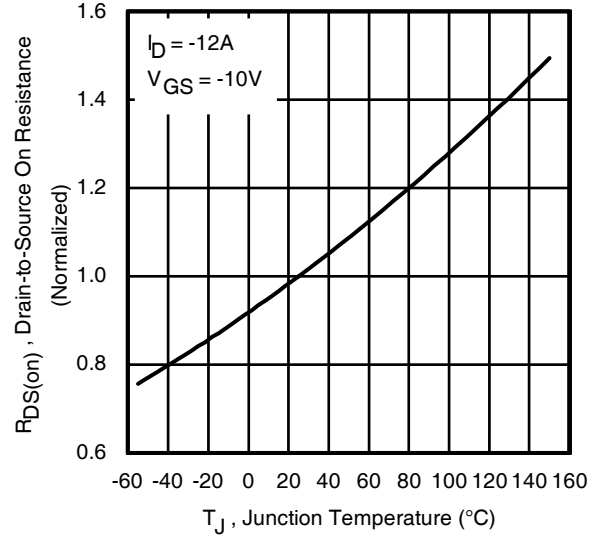

Fig 4. Normalized On-Resistance vs. Temperature

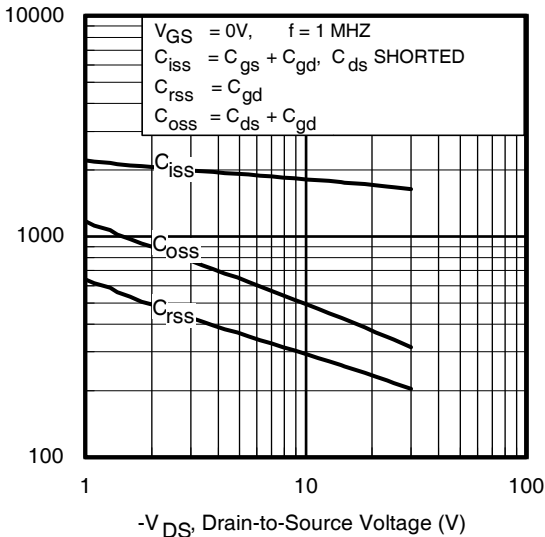

Fig 5. Typical Capacitance vs. Drain-to-Source Voltage

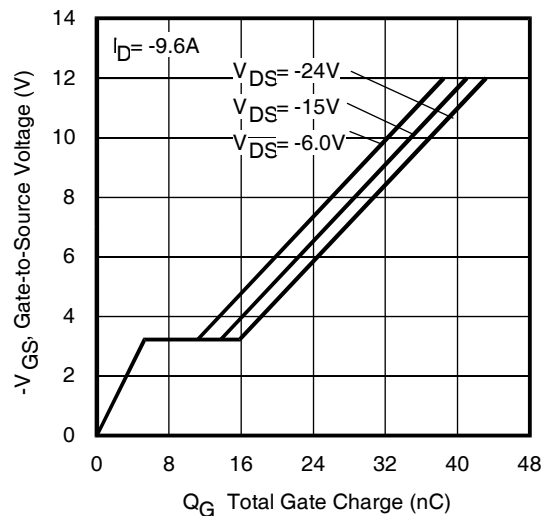

Fig 6. Typical Gate Charge vs. Gate-to-Source Voltage

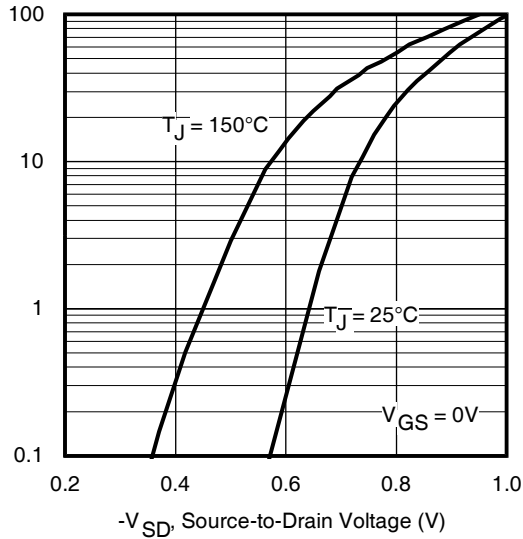

Fig 7. Typical Source-Drain Diode Forward Voltage

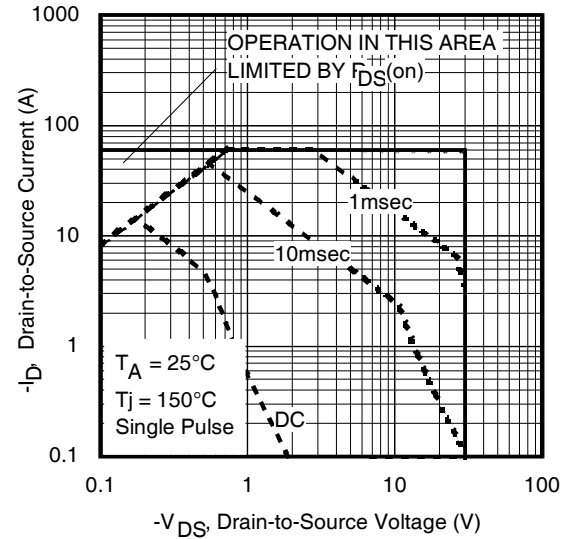

Fig 8. Maximum Safe Operating Area

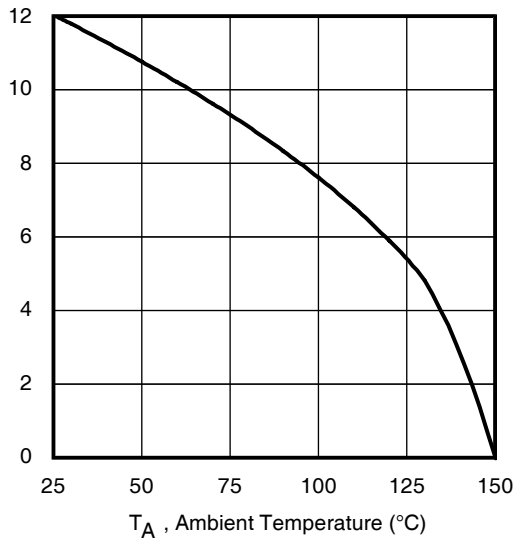

Fig 9. Maximum Drain Current vs. Ambient Temperature

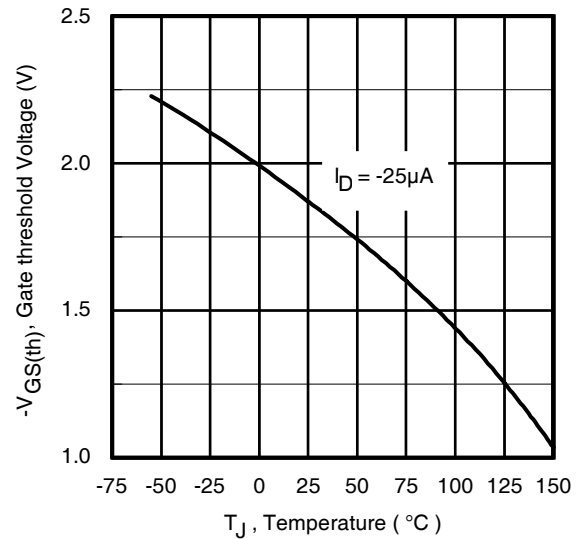

Fig 10. Threshold Voltage vs. Temperature

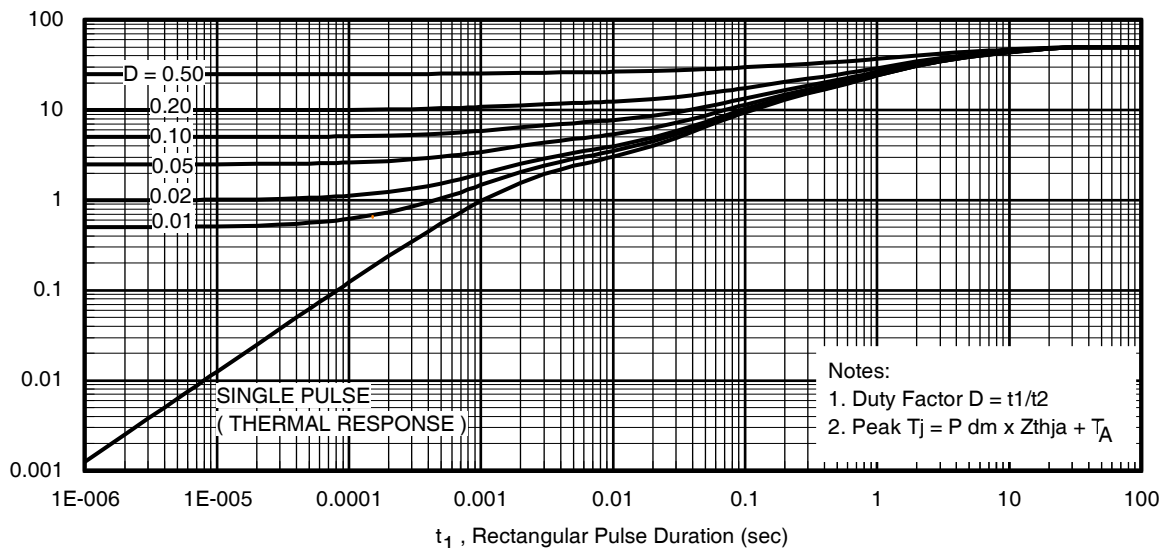

Fig 11. Maximum Effective Transient Thermal Impedance, Junction-to-Ambient

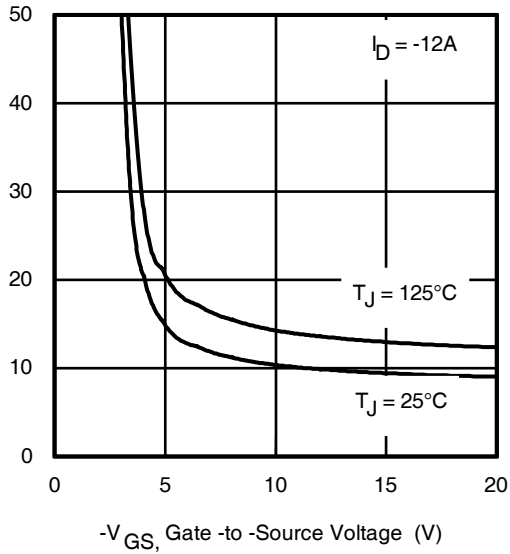

Fig 12. On-Resistance vs. Gate Voltage

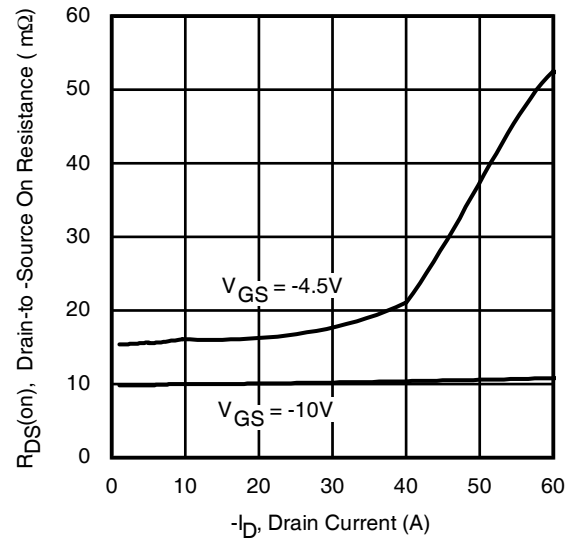

Fig 13. Typical On-Resistance vs. Drain Current

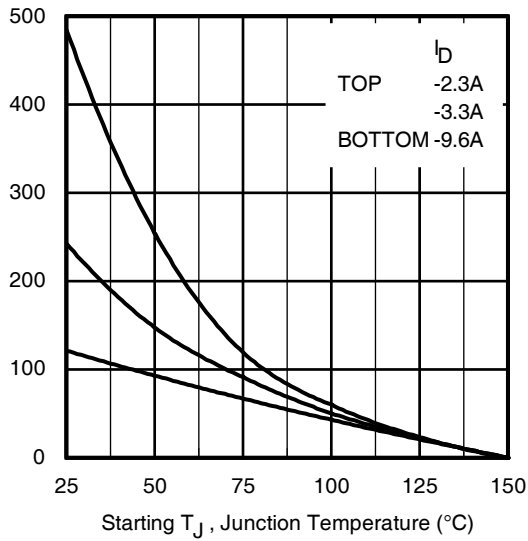

Fig 14. Maximum Avalanche Energy vs. Drain Current

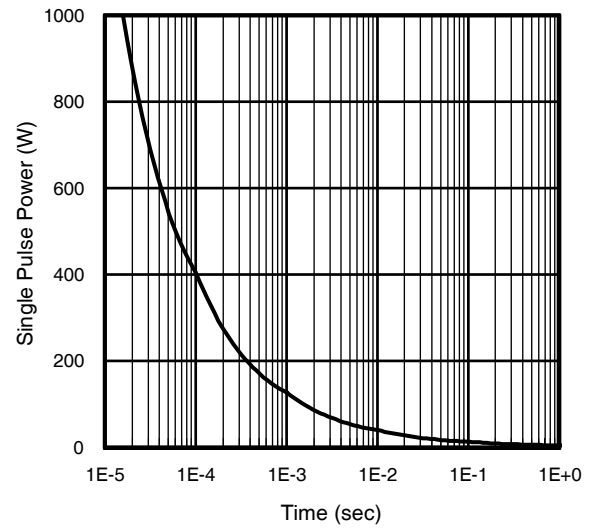

Fig 16. Typical Power vs. Time

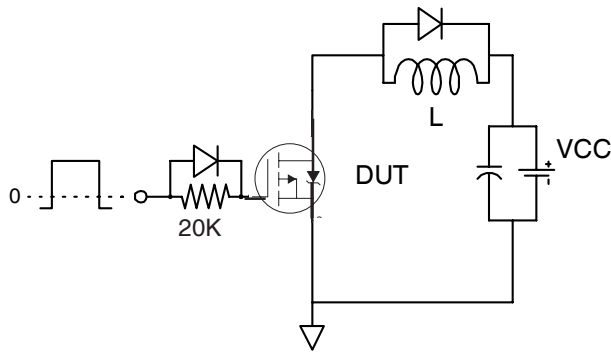

Fig 17a. Gate Charge Test Circuit

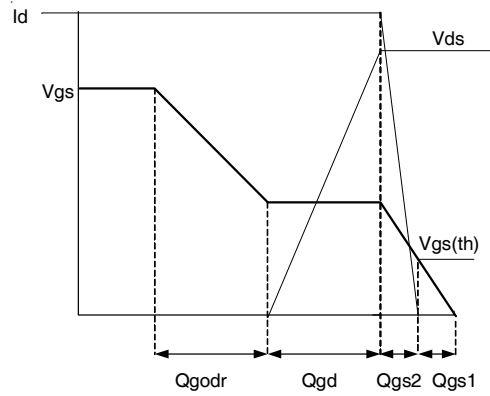

Fig 17b. Gate Charge Waveform

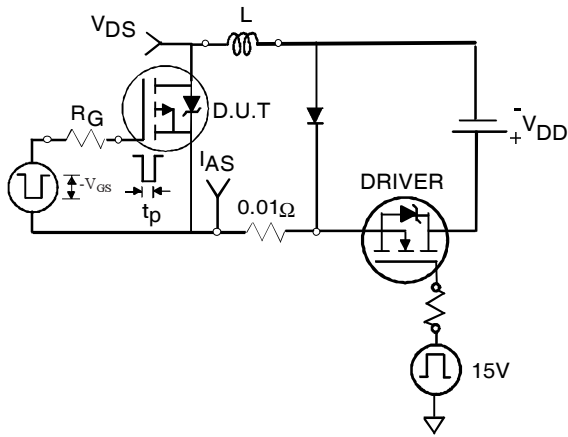

Fig 18a. Unclamped Inductive Test Circuit

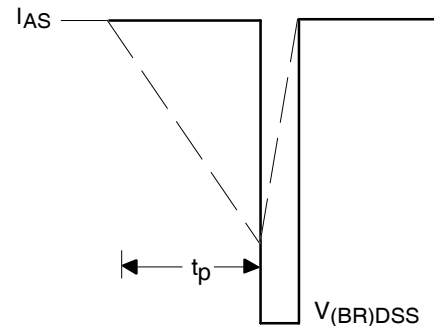

Fig 18b. Unclamped Inductive Waveforms

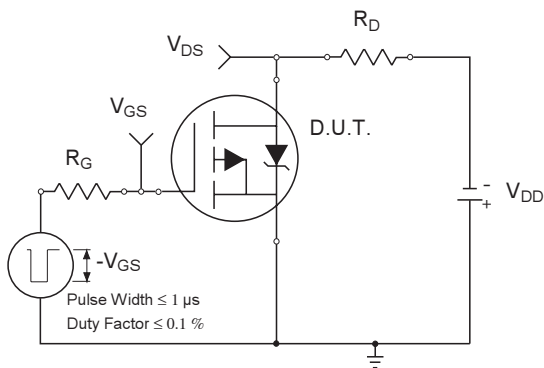

Fig 19a. Switching Time Test Circuit

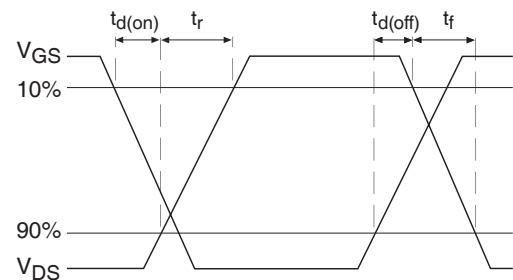
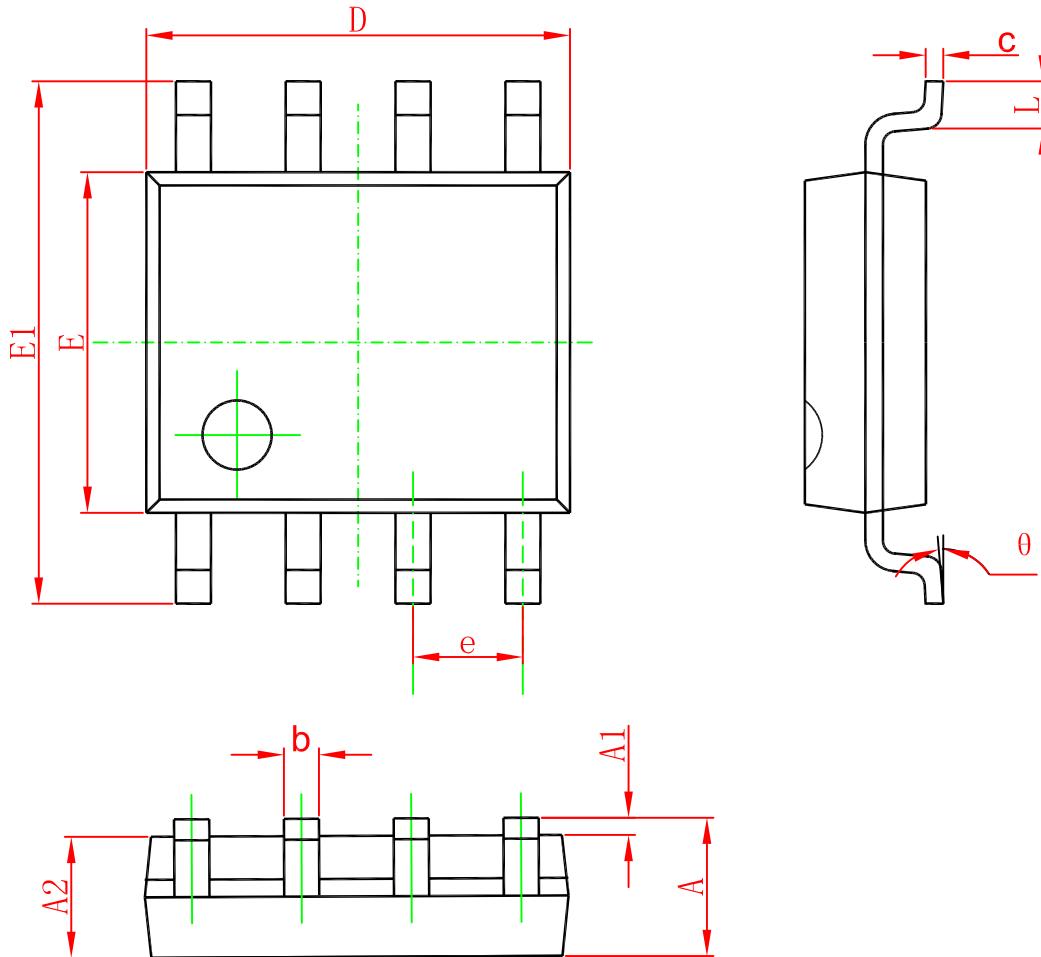

Fig 19b. Switching Time Waveforms

Package Mechanical Data SOP-8



Symbol	Dimensions In Millimeters		Dimensions In Inches	
	Min	Max	Min	Max
A	1.350	1.750	0.053	0.069
A1	0.100	0.250	0.004	0.010
A2	1.350	1.550	0.053	0.061
b	0.330	0.510	0.013	0.020
c	0.170	0.250	0.006	0.010
D	4.700	5.100	0.185	0.200
E	3.800	4.000	0.150	0.157
E1	5.800	6.200	0.228	0.244
e	1.270(BSC)		0.050(BSC)	
L	0.400	1.270	0.016	0.050
theta	0°	8°	0°	8°

Marking

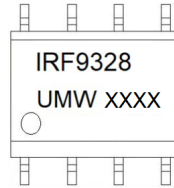

Ordering information

Order code	Package	Baseqty	Deliverymode
UMW IRF9328TR	SOP-8	3000	Tape and reel

X-ON Electronics

Largest Supplier of Electrical and Electronic Components

Click to view similar products for [MOSFET](#) category:

Click to view products by [Youtai](#) manufacturer:

Other Similar products are found below :

[IRFD120](#) [JANTX2N5237](#) [2SK2267\(Q\)](#) [BUK455-60A/B](#) [TK100A10N1,S4X\(S](#) [MIC4420CM-TR](#) [VN1206L](#) [NDP4060](#) [SI4482DY](#)
[IRS2092STRPBF-EL](#) [IPS70R2K0CEAKMA1](#) [TK31J60W5,S1VQ\(O](#) [TK31J60W,S1VQ\(O](#) [TK16J60W,S1VQ\(O](#) [2SK2614\(TE16L1,Q\)](#)
[DMN1017UCP3-7](#) [EFC2J004NUZTDG](#) [P85W28HP2F-7071](#) [DMN1053UCP4-7](#) [NTE2384](#) [DMC2700UDMQ-7](#) [DMN2080UCB4-7](#)
[DMN61D9UWQ-13](#) [US6M2GTR](#) [DMN31D5UDJ-7](#) [DMP22D4UFO-7B](#) [IPS60R3K4CEAKMA1](#) [DMN1006UCA6-7](#) [DMN16M9UCA6-7](#)
[STF5N65M6](#) [IRF40H233XTMA1](#) [STU5N65M6](#) [DMN6022SSD-13](#) [DMN13M9UCA6-7](#) [DMTH10H4M6SPS-13](#) [IPS60R360PFD7SAKMA1](#)
[DMN2990UFB-7B](#) [SSM3K35CT,L3F](#) [IPLK60R1K0PFD7ATMA1](#) [2N7002W-G](#) [MCAC30N06Y-TP](#) [IPWS65R035CFD7AXKSA1](#)
[MCQ7328-TP](#) [SSM3J143TU,LXHF](#) [DMN12M3UCA6-7](#) [PJMF280N65E1_T0_00201](#) [PJMF380N65E1_T0_00201](#)
[PJMF280N60E1_T0_00201](#) [PJMF600N65E1_T0_00201](#) [PJMF900N65E1_T0_00201](#)