

Features

- $V_{DS} (V) = 30V$
- $R_{DS(ON)} < 5.8m\Omega$ ($V_{GS} = 10V$)
- $R_{DS(ON)} < 8 m\Omega$ ($V_{GS} = 4.5V$)

Applications

- High Frequency Synchronous Buck Converters for Computer Processor Power
- High Frequency Isolated DC-DC Converters with Synchronous Rectification for Telecom and Industrial Use

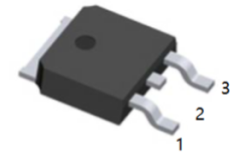

1.G 2.D 3.S
TO-252(DPAK) top view

Benefits

- Very Low $R_{DS(on)}$ at 4.5V V_{GS}
- Ultra-Low Gate Impedance
- Fully Characterized Avalanche Voltage and Current

Absolute Maximum Ratings

	Parameter	Max.	Units
V_{DS}	Drain-to-Source Voltage	30	V
V_{GS}	Gate-to-Source Voltage	± 20	
$I_D @ T_C = 25^\circ C$	Continuous Drain Current, $V_{GS} @ 10V$	86 ^④	A
$I_D @ T_C = 100^\circ C$	Continuous Drain Current, $V_{GS} @ 10V$	61 ^④	
I_{DM}	Pulsed Drain Current ^①	340	
$P_D @ T_C = 25^\circ C$	Maximum Power Dissipation ^⑥	75	W
$P_D @ T_C = 100^\circ C$	Maximum Power Dissipation ^⑥	38	
	Linear Derating Factor	0.5	W/ $^\circ C$
T_J	Operating Junction and	-55 to + 175	$^\circ C$
T_{STG}	Storage Temperature Range		
	Soldering Temperature, for 10 seconds	300 (1.6mm from case)	

Thermal Resistance

	Parameter	Typ.	Max.	Units
$R_{\theta JC}$	Junction-to-Case ^⑥		2.0	$^\circ C/W$
$R_{\theta JA}$	Junction-to-Ambient (PCB Mount) ^⑤		50	
$R_{\theta JA}$	Junction-to-Ambient		110	

Notes

- ① Repetitive rating; pulse width limited by max. junction temperature.
- ② Starting $T_J = 25^\circ C$, $L = 0.605mH$, $R_G = 25\Omega$, $I_{AS} = 20A$.
- ③ Pulse width $\leq 400\mu s$; duty cycle $\leq 2\%$.
- ④ Calculated continuous current based on maximum allowable junction temperature. Package limitation current is 50A.
- ⑤ When mounted on 1" square PCB (FR-4 or G-10 Material).For recommended footprint and soldering techniques refer to application note #AN-994.
- ⑥ R_θ is measured at T_J approximately at $90^\circ C$

Static @ $T_J = 25^\circ\text{C}$ (unless otherwise specified)

	Parameter	Min.	Typ.	Max.	Units	Conditions
BV_{DSS}	Drain-to-Source Breakdown Voltage	30			V	$V_{GS} = 0V, I_D = 250\mu A$
$\Delta BV_{DSS}/\Delta T_J$	Breakdown Voltage Temp. Coefficient		20		mV/ $^\circ\text{C}$	Reference to $25^\circ\text{C}, I_D = 1\text{mA}$
$R_{DS(on)}$	Static Drain-to-Source On-Resistance		4.0 5.8	5.8 8.0	m Ω	$V_{GS} = 10V, I_D = 25A$ ③ $V_{GS} = 4.5V, I_D = 20A$ ③
$V_{GS(th)}$	Gate Threshold Voltage	1.35	1.80	2.35	V	$V_{DS} = V_{GS}, I_D = 50\mu A$
$\Delta V_{GS(th)}/\Delta T_J$	Gate Threshold Voltage Coefficient		-8.6		mV/ $^\circ\text{C}$	
I_{DSS}	Drain-to-Source Leakage Current			1.0 150	μA	$V_{DS} = 24V, V_{GS} = 0V$ $V_{DS} = 24V, V_{GS} = 0V, T_J = 125^\circ\text{C}$
I_{GSS}	Gate-to-Source Forward Leakage			100	nA	$V_{GS} = 20V$
	Gate-to-Source Reverse Leakage			-100	nA	$V_{GS} = -20V$
g_{fs}	Forward Transconductance	73			S	$V_{DS} = 15V, I_D = 20A$
Q_g	Total Gate Charge		15	23	nC	$V_{DS} = 15V$ $V_{GS} = 4.5V$ $I_D = 20A$ See Fig. 15
Q_{gs1}	Pre-Vth Gate-to-Source Charge		3.7			
Q_{gs2}	Post-Vth Gate-to-Source Charge		1.9			
Q_{gd}	Gate-to-Drain Charge		5.7			
Q_{godr}	Gate Charge Overdrive		3.7			
Q_{sw}	Switch Charge ($Q_{gs2} + Q_{gd}$)		7.6			
Q_{oss}	Output Charge		10		nC	$V_{DS} = 15V, V_{GS} = 0V$
R_G	Gate Resistance		2.0	3.5	Ω	
$t_{d(on)}$	Turn-On Delay Time		12		ns	$V_{DD} = 15V, V_{GS} = 4.5V$ ③ $I_D = 20A$ $R_G = 1.8\Omega$ See Fig. 13
t_r	Rise Time		49			
$t_{d(off)}$	Turn-Off Delay Time		15			
t_f	Fall Time		16			
C_{iss}	Input Capacitance		2150		pF	$V_{GS} = 0V$ $V_{DS} = 15V$ $f = 1.0\text{MHz}$
C_{oss}	Output Capacitance		480			
C_{rss}	Reverse Transfer Capacitance		205			

Avalanche Characteristics

	Parameter	Typ.	Max.	Units
E_{AS}	Single Pulse Avalanche Energy ②		120	mJ
I_{AR}	Avalanche Current ①		20	A

Diode Characteristics

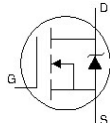
	Parameter	Min.	Typ.	Max.	Units	Conditions
I_S	Continuous Source Current (Body Diode)			86 ④	A	MOSFET symbol showing the integral reverse p-n junction diode. 
I_{SM}	Pulsed Source Current (Body Diode) ①			340		
V_{SD}	Diode Forward Voltage			1.0	V	$T_J = 25^\circ\text{C}, I_S = 20A, V_{GS} = 0V$ ③
t_{rr}	Reverse Recovery Time		24	36	ns	$T_J = 25^\circ\text{C}, I_F = 20A, V_{DD} = 15V$
Q_{rr}	Reverse Recovery Charge		52	78	nC	$di/dt = 300A/\mu s$ ③

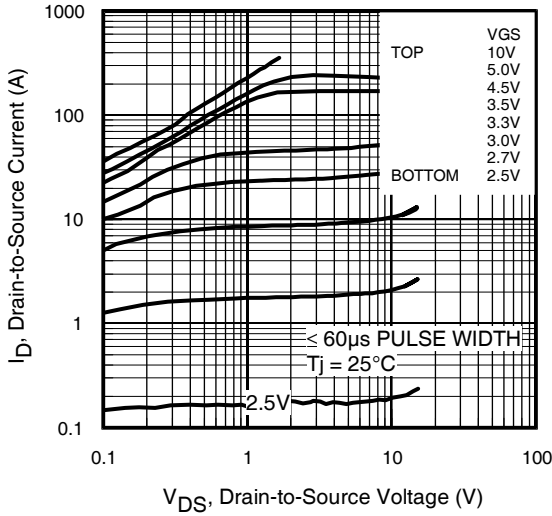

Fig 1. Typical Output Characteristics

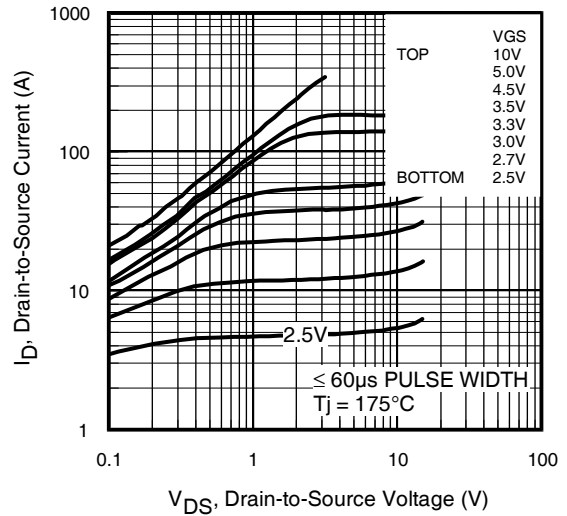

Fig 2. Typical Output Characteristics

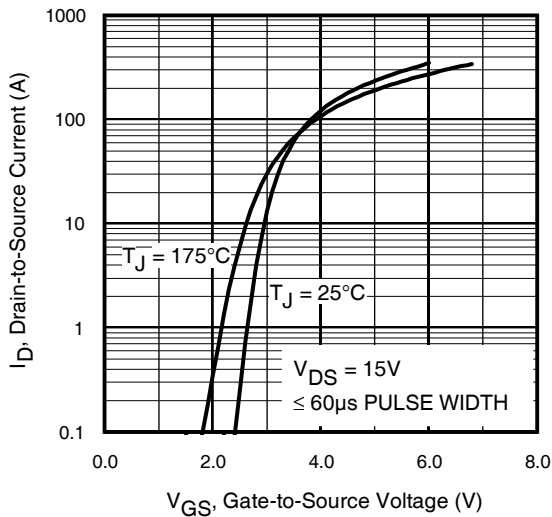

Fig 3. Typical Transfer Characteristics

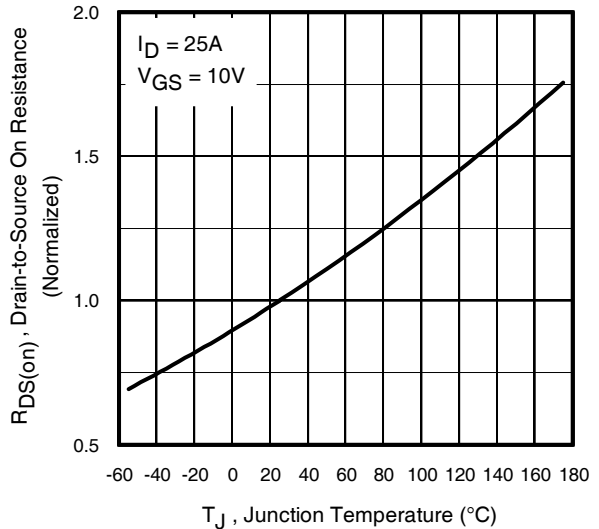

Fig 4. Normalized On-Resistance vs. Temperature

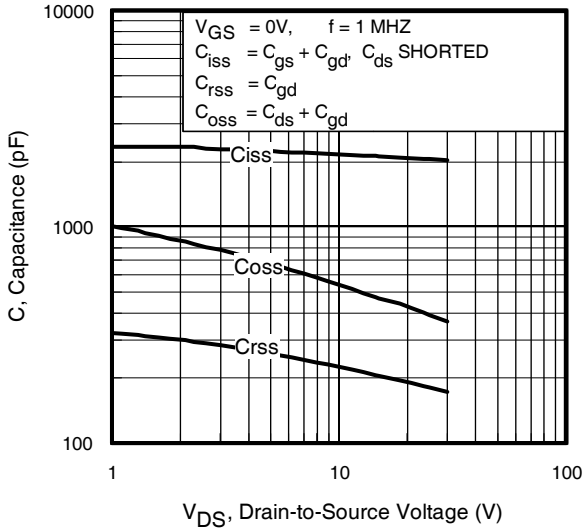

Fig 5. Typical Capacitance vs. Drain-to-Source Voltage

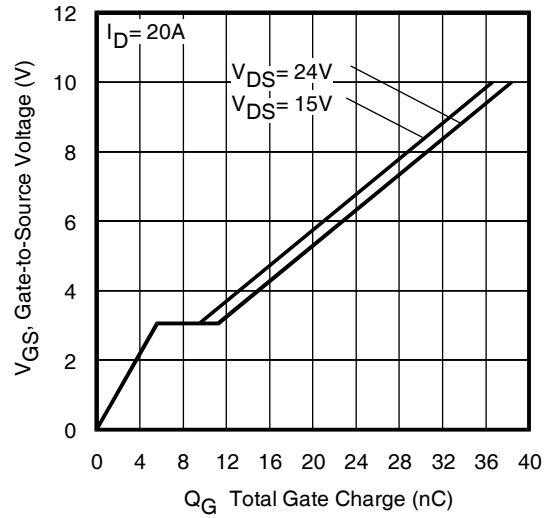

Fig 6. Typical Gate Charge vs. Gate-to-Source Voltage

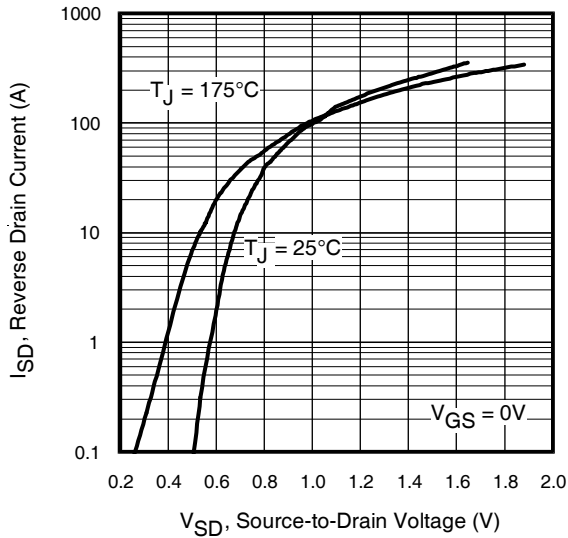

Fig 7. Typical Source-Drain Diode Forward Voltage

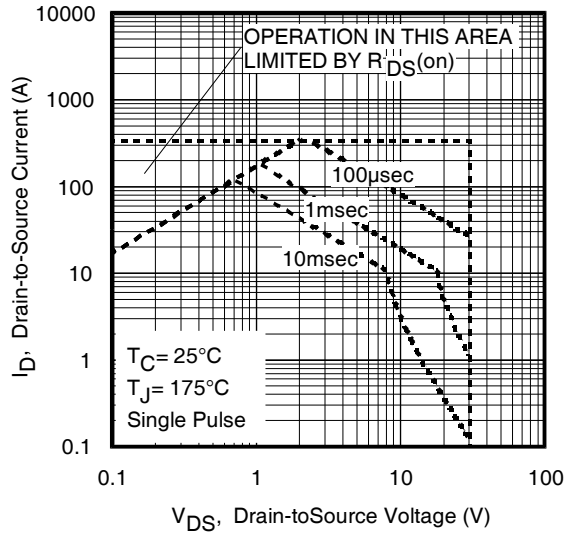

Fig 8. Maximum Safe Operating Area

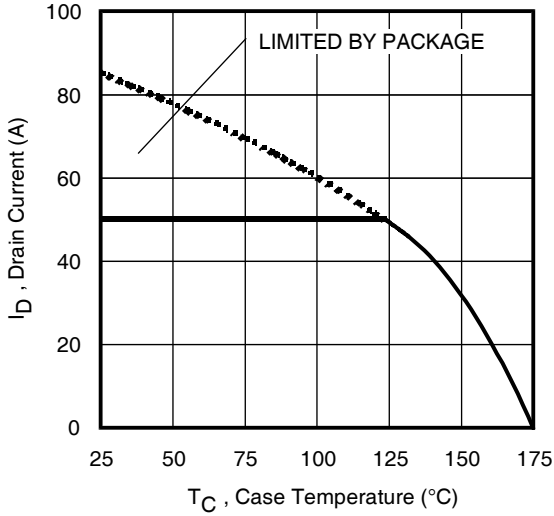

Fig 9. Maximum Drain Current vs. Case Temperature

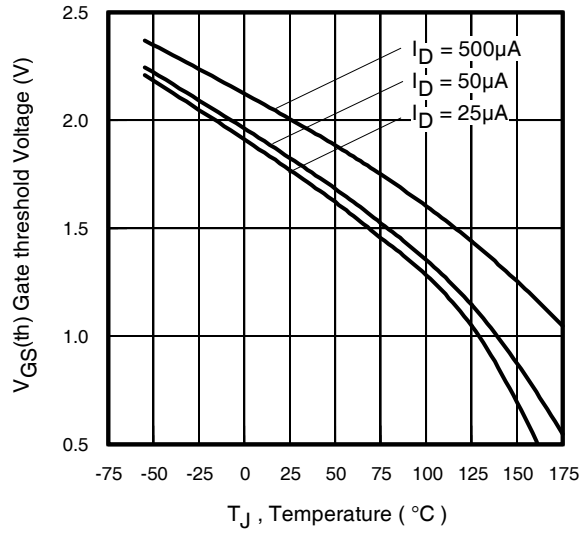

Fig 10. Threshold Voltage vs. Temperature

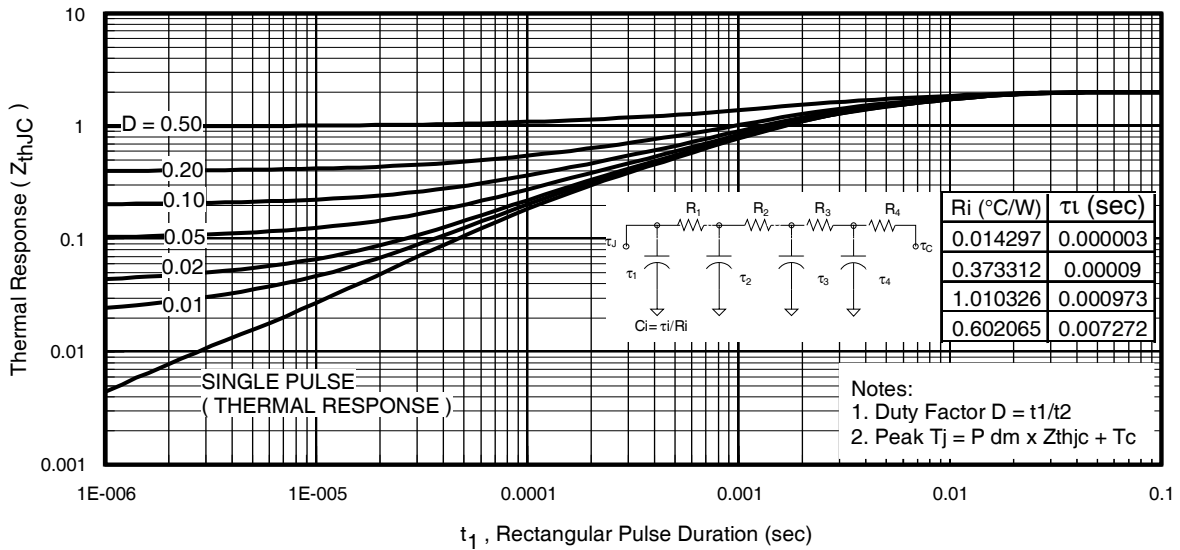

Fig 11. Maximum Effective Transient Thermal Impedance, Junction-to-Case

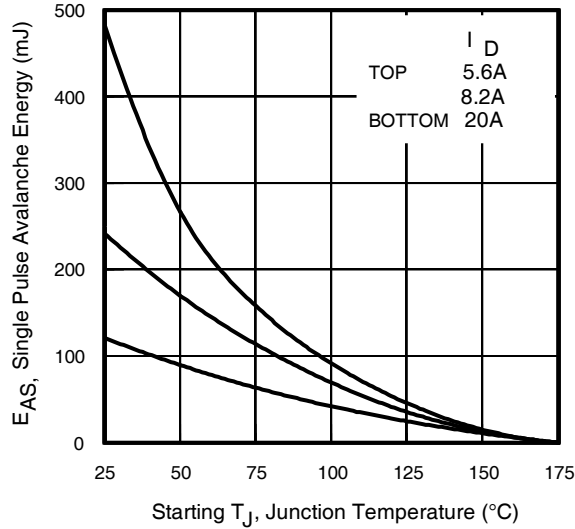

Fig 12a. Maximum Avalanche Energy Vs. Drain Current

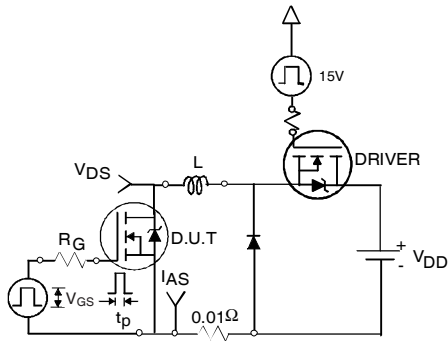

Fig 12b. Unclamped Inductive Test Circuit

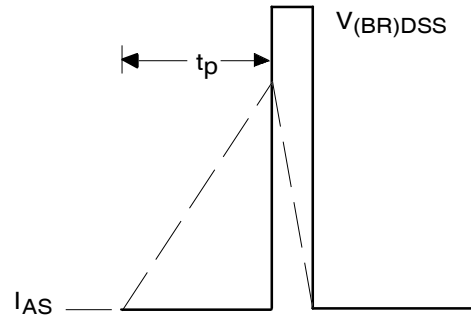

Fig 12c. Unclamped Inductive Waveforms

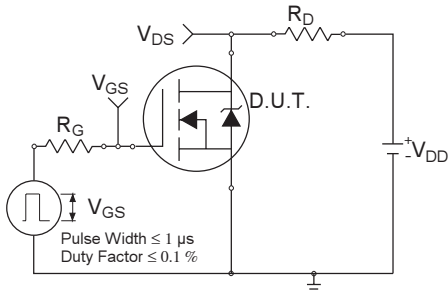

Fig 13a. Switching Time Test Circuit

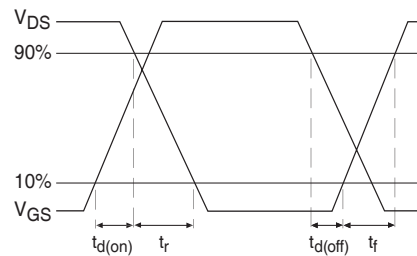
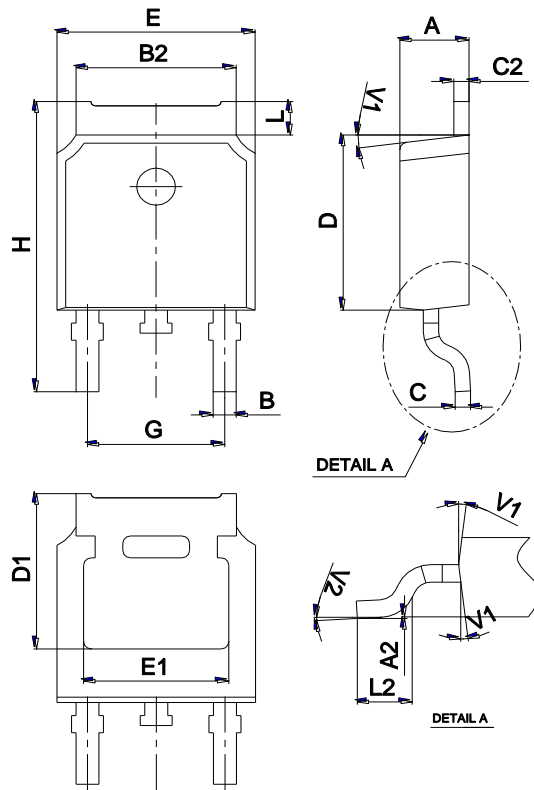

Fig 13b. Switching Time Waveforms

Package Mechanical Data TO-252



Ref.	Dimensions					
	Millimeters			Inches		
	Min.	Typ.	Max.	Min.	Typ.	Max.
A	2.10		2.50	0.083		0.098
A2	0		0.10	0		0.004
B	0.66		0.86	0.026		0.034
B2	5.18		5.48	0.202		0.216
C	0.40		0.60	0.016		0.024
C2	0.44		0.58	0.017		0.023
D	5.90		6.30	0.232		0.248
D1	5.30REF			0.209REF		
E	6.40		6.80	0.252		0.268
E1	4.63			0.182		
G	4.47		4.67	0.176		0.184
H	9.50		10.70	0.374		0.421
L	1.09		1.21	0.043		0.048
L2	1.35		1.65	0.053		0.065
V1		7°			7°	
V2	0°		6°	0°		6°

Marking

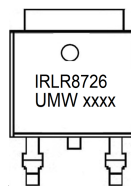

Ordering information

Order code	Package	Baseqty	Deliverymode
UMW IRLR8726TR	TO-252	2500	Tape and reel

X-ON Electronics

Largest Supplier of Electrical and Electronic Components

Click to view similar products for [MOSFET](#) category:

Click to view products by [Youtai](#) manufacturer:

Other Similar products are found below :

[IRFD120](#) [JANTX2N5237](#) [BUK455-60A/B](#) [MIC4420CM-TR](#) [VN1206L](#) [NDP4060](#) [SI4482DY](#) [IPS70R2K0CEAKMA1](#) [SQD23N06-31L-GE3](#)
[TK16J60W,S1VQ\(O](#) [2SK2614\(TE16L1,Q\)](#) [DMN1017UCP3-7](#) [DMN1053UCP4-7](#) [SQJ469EP-T1-GE3](#) [NTE2384](#) [DMC2700UDMQ-7](#)
[DMN2080UCB4-7](#) [DMN61D9UWQ-13](#) [US6M2GTR](#) [DMN31D5UDJ-7](#) [DMP22D4UFO-7B](#) [DMN1006UCA6-7](#) [DMN16M9UCA6-7](#)
[STF5N65M6](#) [IRF40H233XTMA1](#) [STU5N65M6](#) [DMN6022SSD-13](#) [DMN13M9UCA6-7](#) [DMTH10H4M6SPS-13](#) [DMN2990UFB-7B](#)
[IPB80P04P405ATMA2](#) [2N7002W-G](#) [MCAC30N06Y-TP](#) [MCQ7328-TP](#) [BXP7N65D](#) [BXP4N65F](#) [AOL1454G](#) [WMJ80N60C4](#) [BXP2N20L](#)
[BXP2N65D](#) [BXT1150N10J](#) [BXT1700P06M](#) [TSM60NB380CP](#) [ROG](#) [RQ7L055BGTCR](#) [DMNH15H110SK3-13](#) [SLF10N65ABV2](#)
[BSO203SP](#) [BSO211P](#) [IPA60R230P6](#) [IPA60R460CE](#)