

SOT-23 Plastic-Encapsulate Transistors

MMBT4403 TRANSISTOR (PNP)

FEATURES

Switching transistor

MARKING : 2T

MAXIMUM RATINGS (T_a=25°C unless otherwise noted)

Symbol	Parameter	Value	Unit
V _{CB0}	Collector-Base Voltage	-40	V
V _{CEO}	Collector-Emitter Voltage	-40	V
V _{EBO}	Emitter-Base Voltage	-5	V
I _C	Collector Current -Continuous	-0.6	A
P _C	Collector Power Dissipation	0.3	W
T _j	Junction Temperature	150	°C
T _{stg}	Storage Temperature	-55-150	°C

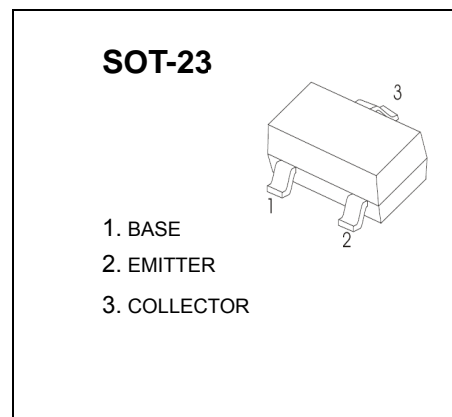

ELECTRICAL CHARACTERISTICS (T_a=25°C unless otherwise specified)

Parameter	Symbol	Test conditions	Min	Max	Unit
Collector-base breakdown voltage	V _{(BR)CBO}	I _C =-100μA, I _E =0	-40		V
Collector-emitter breakdown voltage	V _{(BR)CEO}	I _C =-1mA, I _B =0	-40		V
Emitter-base breakdown voltage	V _{(BR)EBO}	I _E =-100μA, I _C =0	-5		V
Collector cut-off current	I _{CBO}	V _{CB} =-35V, I _E =0		-0.1	μA
Collector cut-off current	I _{CEO}	V _{CE} =-35 V, I _B =0		-0.1	μA
Emitter cut-off current	I _{EBO}	V _{EB} =-4V, I _C =0		-0.1	μA
DC current gain	h _{FE}	V _{CE} =-2V, I _C =-150mA	100	300	
Collector-emitter saturation voltage	V _{CE(sat)}	I _C =-150mA, I _B =-15mA		-0.4	V
Base-emitter saturation voltage	V _{BE(sat)}	I _C =-150mA, I _B =-15mA		-0.95	V
Transition frequency	f _T	V _{CE} =-10V, I _C =-20mA f = 100MHz	200		MHz
Delay time	t _d	V _{CC} =-30V, V _{EB} =-2V, I _C =-150mA, I _{B1} =-15mA		15	ns
Rise time	t _r			20	ns
Storage time	t _s	V _{CC} =-30V, I _C =-150mA, I _{B1} = I _{B2} =-15mA		225	ns
Fall time	t _f			30	ns

Typical Characteristics

MMBT4403

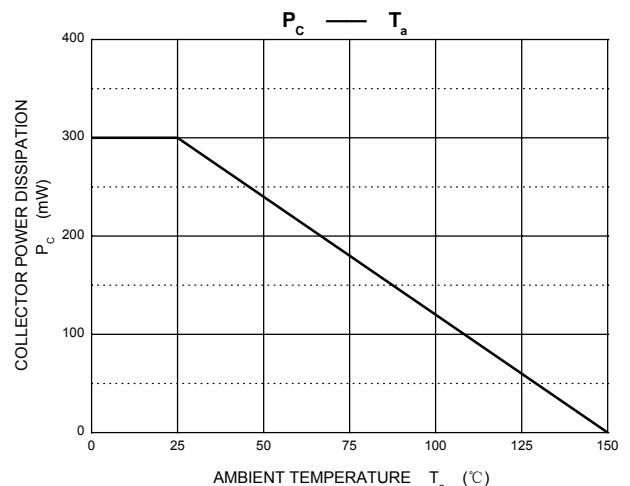
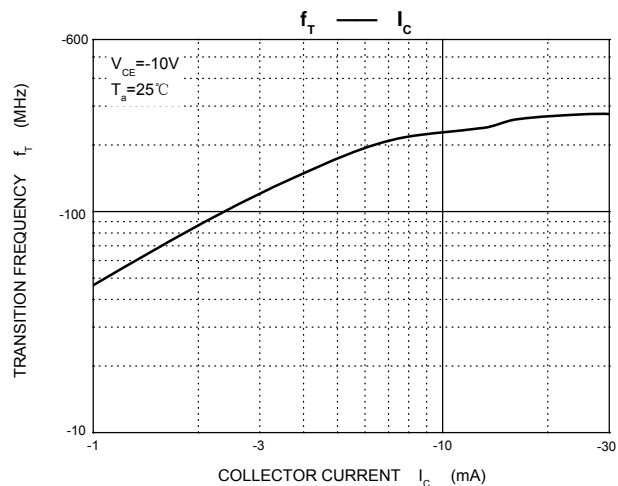
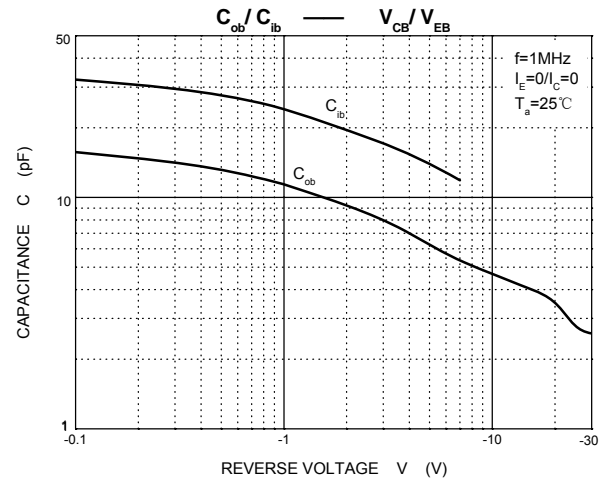
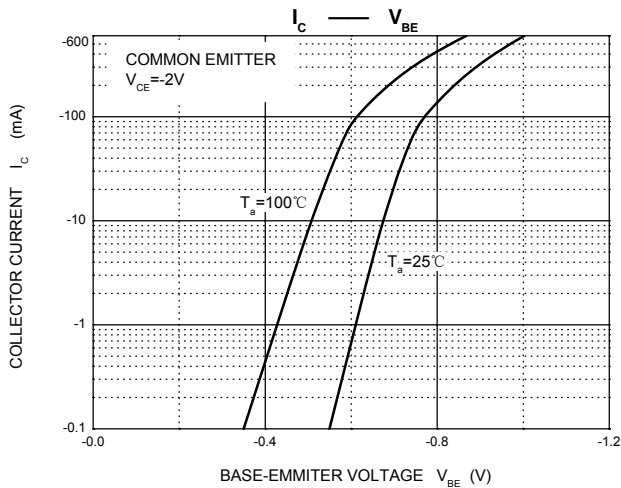
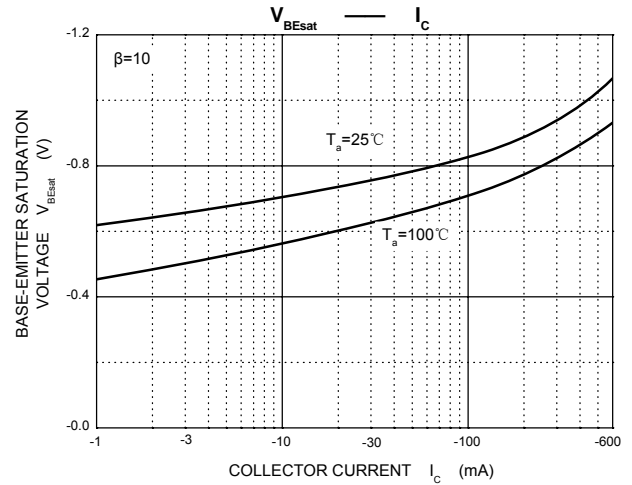
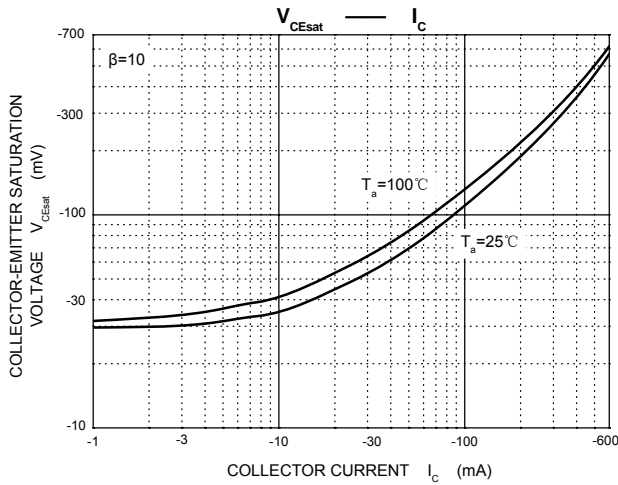
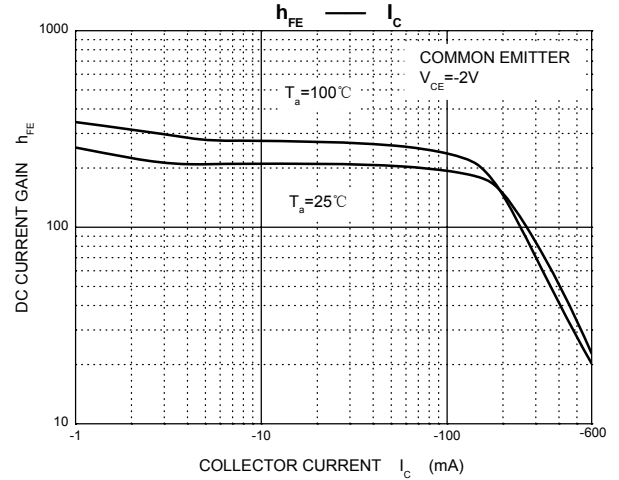
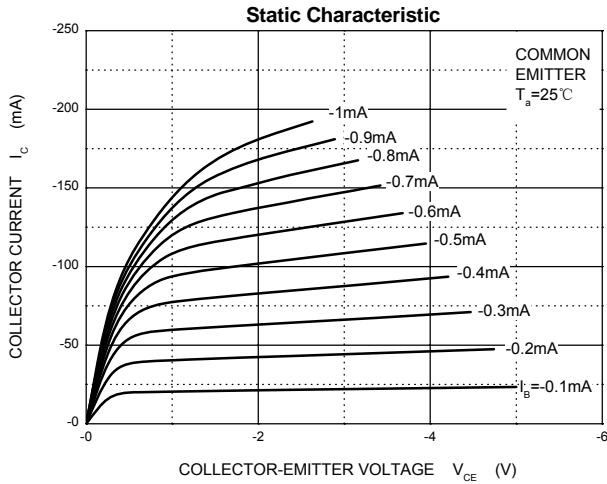

X-ON Electronics

Largest Supplier of Electrical and Electronic Components

Click to view similar products for [Bipolar Transistors - BJT category](#):

Click to view products by [Youtai manufacturer](#):

Other Similar products are found below :

[619691C](#) [MCH4017-TL-H](#) [MJ15024/WS](#) [MJ15025/WS](#) [BC546/116](#) [BC556/FSC](#) [BC557/116](#) [BSW67A](#) [HN7G01FU-A\(T5L,F,T](#)
[NJVMJD148T4G](#) [NSVMMBT6520LT1G](#) [NTE187A](#) [NTE195A](#) [NTE2302](#) [NTE2330](#) [NTE2353](#) [NTE316](#) [IMX9T110](#) [NTE63](#) [NTE65](#)
[C4460](#) [SBC846BLT3G](#) [2SA1419T-TD-H](#) [2SA1721-O\(TE85L,F\)](#) [2SA1727TLP](#) [2SA2126-E](#) [2SB1202T-TL-E](#) [2SB1204S-TL-E](#) [2SC5488A-](#)
[TL-H](#) [2SD2150T100R](#) [SP000011176](#) [FMC5AT148](#) [2N2369ADCSM](#) [2SB1202S-TL-E](#) [2SC2412KT146S](#) [2SC4618TLN](#) [2SC5490A-TL-H](#)
[2SD1816S-TL-E](#) [2SD1816T-TL-E](#) [CMXT2207 TR](#) [CPH6501-TL-E](#) [MCH4021-TL-E](#) [BC557B](#) [TTC012\(Q\)](#) [BULD128DT4](#) [JANTX2N3810](#)
[Jantx2N5416](#) [US6T6TR](#) [KSF350](#) [068071B](#)