

**DESCRIPTION**

The small size and low power consumption (34µA per channel maximum) of the OPA347 make it ideal for portable and battery-powered applications. The input range of the OPA347 extends 200mV beyond the rails, and the output range is within 5mV of the rails. The OPA347 also features an excellent speed/power ratio with a bandwidth of 350kHz.

The OPA347 can be operated with a single or dual power supply from 2.3V to 5.5V. All models are specified for operation from -55°C to +125°C.

**FEATURES**

- LOW I<sub>Q</sub>: 20µA
- HIGH SPEED/POWER RATIO WITH BANDWIDTH: 350kHz
- RAIL-TO-RAIL INPUT AND OUTPUT
- SINGLE SUPPLY: 2.3V to 5.5V

**APPLICATIONS**

- PORTABLE EQUIPMENT
- BATTERY-POWERED EQUIPMENT
- 2-WIRE TRANSMITTERS
- SMOKE DETECTORS
- CO DETECTORS

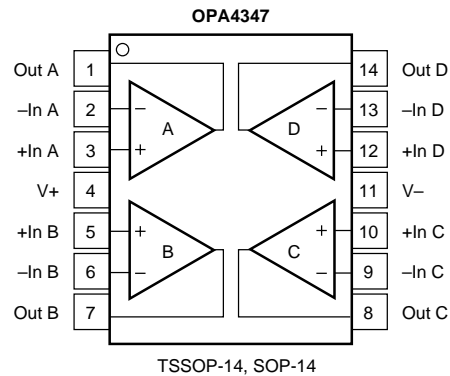
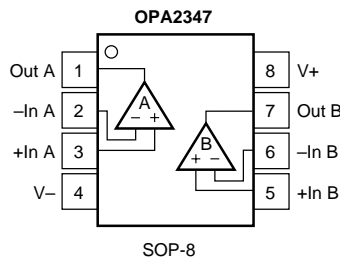
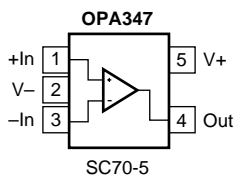

## microPower, Rail-to-Rail Operational Amplifiers

### ELECTRICAL CHARACTERISTICS: $V_S = 2.5V$ to $5.5V$

Boldface limits apply over the specified temperature range,  $T_A = -55^\circ C$  to  $+125^\circ C$ .

At  $T_A = +25^\circ C$ ,  $R_L = 100k\Omega$  connected to  $V_S/2$  and  $V_{OUT} = V_S/2$ , unless otherwise noted.

PARAMETER	CONDITION	OPA347SA OPA2347UA, OPA4347EA, UA			UNITS
		MIN	TYP	MAX	
Input Offset Voltage	$V_{OS}$	$V_S = 5.5V, V_{CM} = (V-) + 0.8V$			mV
over Temperature			2	6	mV
Drift	$dV_{OS}/dT$		3	7	$\mu V/^\circ C$
vs Power Supply	PSRR	$V_S = 2.5V$ to $5.5V, V_{CM} < (V+) - 1.7V$			$\infty V/V$
over Temperature		$V_S = 2.5V$ to $5.5V, V_{CM} < (V+) - 1.7V$			$\infty V/V$
Channel Separation, DC			0.3		$\mu V/V$
	$f = 1kHz$		128		dB
Common-Mode Voltage Range	$V_{CM}$	$(V-) - 0.2$		$(V+) + 0.2$	V
Common-Mode Rejection Ratio	CMRR	$V_S = 5.5V, (V-) - 0.2V < V_{CM} < (V+) - 1.7V$			dB
over Temperature		$V_S = 5.5V, V- < V_{CM} < (V+) - 1.7V$			dB
		$V_S = 5.5V, (V-) - 0.2V < V_{CM} < (V+) + 0.2V$			dB
over Temperature		$V_S = 5.5V, V- < V_{CM} < V+$			dB
Input Bias Current	$I_b$		$\pm 0.5$	$\pm 10$	pA
Input Offset Current	$I_{OS}$		$\pm 0.5$	$\pm 10$	pA
Differential			$10^{13} \parallel 3$		$\Omega \parallel pF$
Common-Mode			$10^{13} \parallel 6$		$\Omega \parallel pF$
NOISE	$V_{CM} < (V+) - 1.7V$				
Input Voltage Noise, $f = 0.1Hz$ to $10Hz$			12		$\mu V_{pp}$
Input Voltage Noise Density, $f = 1kHz$	$e_n$		60		$nV/\sqrt{Hz}$
Input Current Noise Density, $f = 1kHz$	$i_n$		0.7		$fA/\sqrt{Hz}$
Open-Loop Voltage Gain	$A_{OL}$	$V_S = 5.5V, R_L = 100k\Omega, 0.015V < V_O < 5.485V$			dB
over Temperature		$V_S = 5.5V, R_L = 100k\Omega, 0.015V < V_O < 5.485V$			dB
		$V_S = 5.5V, R_L = 5k\Omega, 0.125V < V_O < 5.375V$			dB
over Temperature		$V_S = 5.5V, R_L = 5k\Omega, 0.125V < V_O < 5.375V$			dB
$A_{OL}$ (SC-70 only)		$V_S = 5.5V, R_L = 5k\Omega, 0.125V < V_O < 5.375V$			dB
Voltage Output Swing from Rail		$R_L = 100k\Omega, A_{OL} > 100dB$			mV
over Temperature		$R_L = 100k\Omega, A_{OL} > 88dB$			mV
		$R_L = 5k\Omega, A_{OL} > 100dB$			mV
over Temperature		$R_L = 5k\Omega, A_{OL} > 88dB$			mV
Short-Circuit Current	$I_{SC}$		$\pm 17$		mA
Capacitive Load Drive	$C_{LOAD}$	See Typical Characteristics			
FREQUENCY RESPONSE	$C_L = 100pF$				
Gain-Bandwidth Product	GBW		350		kHz
Slew Rate	SR		0.17		$V/\mu s$
Settling Time, 0.1%	$t_s$	$V_S = 5V, 2V$ Step, $G = +1$			$\mu s$
0.01%		$V_S = 5V, 2V$ Step, $G = +1$			$\mu s$
Overload Recovery Time		$V_{IN} \times Gain = V_S$			$\mu s$
Specified Voltage Range	$V_S$	2.5		5.5	V
Minimum Operating Voltage			2.3		V
Minimum Operating Voltage (OPA347SA)			2.4		V
Quiescent Current (per amplifier)	$I_Q$		20	34	$\mu A$
over Temperature				38	$\mu A$
Specified Range		-55		125	$^\circ C$
Operating Range		-65		150	$^\circ C$
Storage Range		-65		150	$^\circ C$
Thermal Resistance	$\theta_{JA}$				
SOT23-5 Surface-Mount			200		$^\circ C/W$
SOT23-8 Surface-Mount			150		$^\circ C/W$
SO-8 Surface-Mount			150		$^\circ C/W$
SO-14 Surface-Mount			100		$^\circ C/W$
TSSOP-14 Surface-Mount			100		$^\circ C/W$
DIP-8			100		$^\circ C/W$
SC70-5 Surface-Mount			250		$^\circ C/W$
WCSP			250		$^\circ C/W$

### TYPICAL CHARACTERISTICS

At  $T_A = +25^\circ\text{C}$ ,  $V_S = +5\text{V}$ , and  $R_L = 100\text{k}\Omega$  connected to  $V_S/2$ , unless otherwise noted.

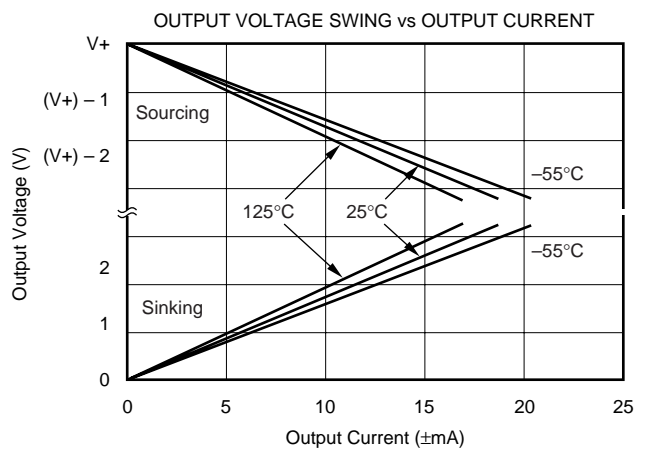
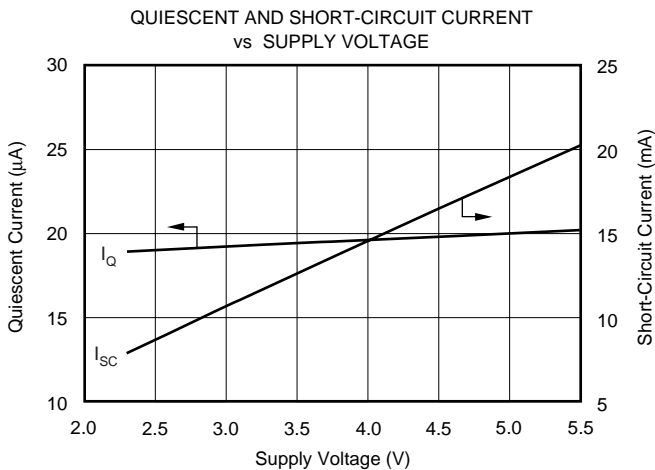
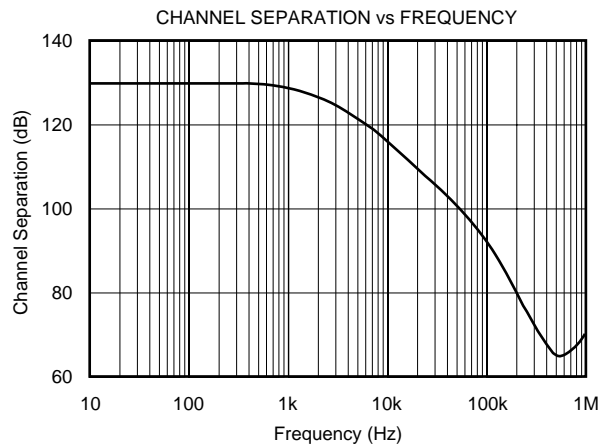
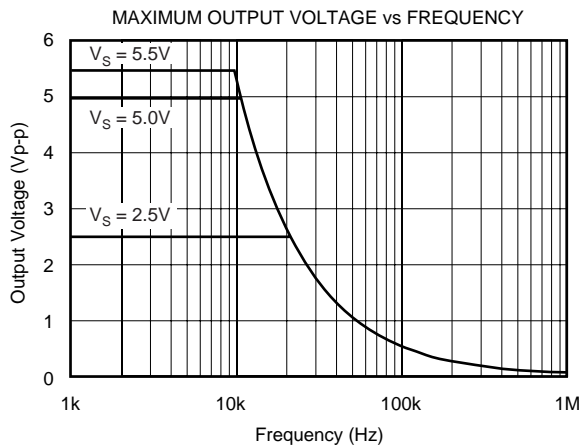
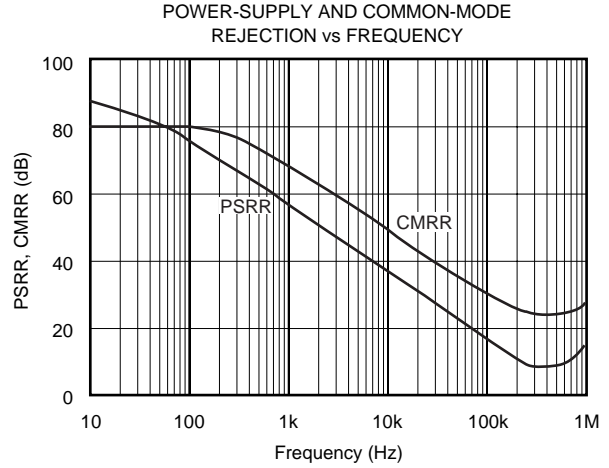
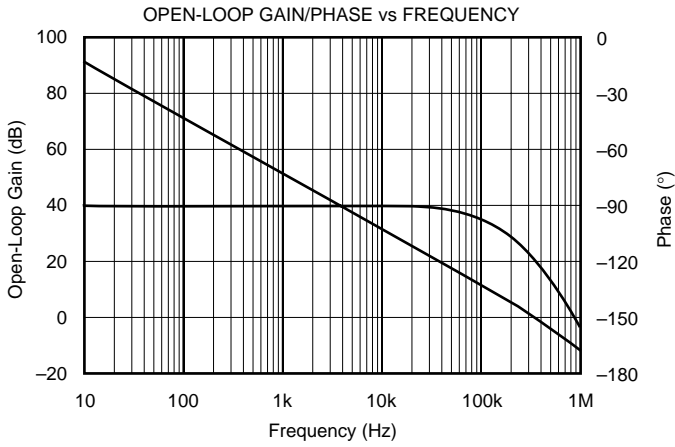

**TYPICAL CHARACTERISTICS(Cont.)**

At  $T_A = +25^\circ\text{C}$ ,  $V_S = +5\text{V}$ , and  $R_L = 100\text{k}\Omega$  connected to  $V_S/2$ , unless otherwise noted.

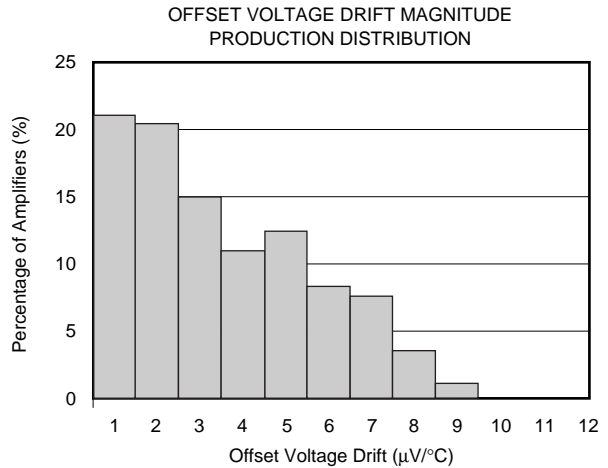
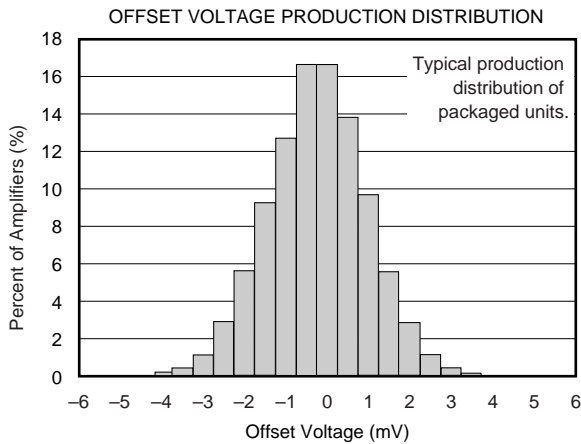
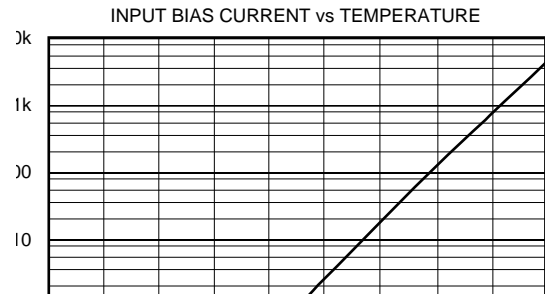
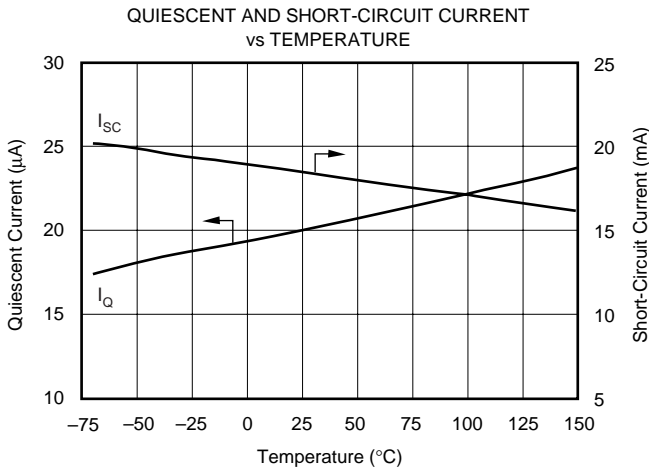
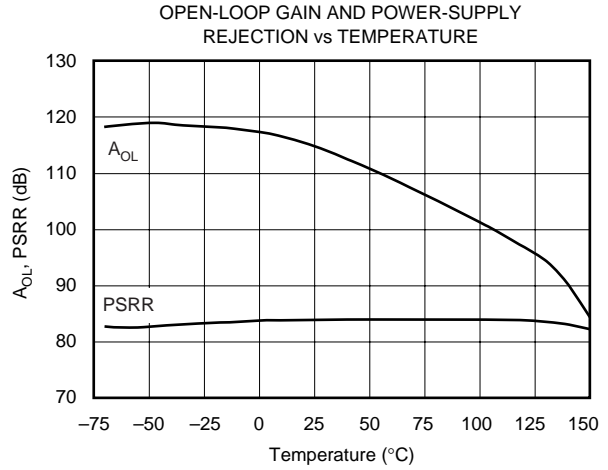
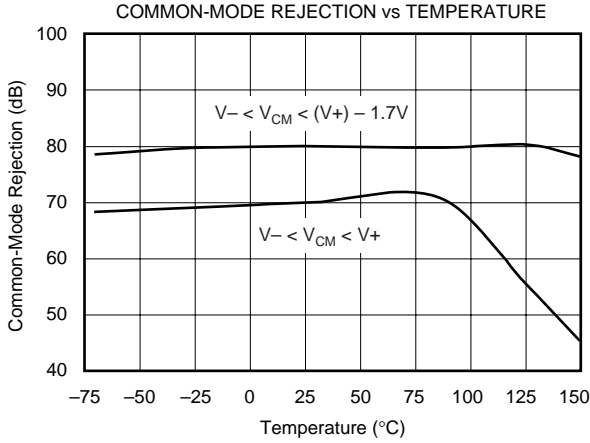

**TYPICAL CHARACTERISTICS (Cont.)**

At  $T_A = +25^\circ\text{C}$ ,  $V_S = +5\text{V}$ , and  $R_L = 100\text{k}\Omega$  connected to  $V_S/2$ , unless otherwise noted.

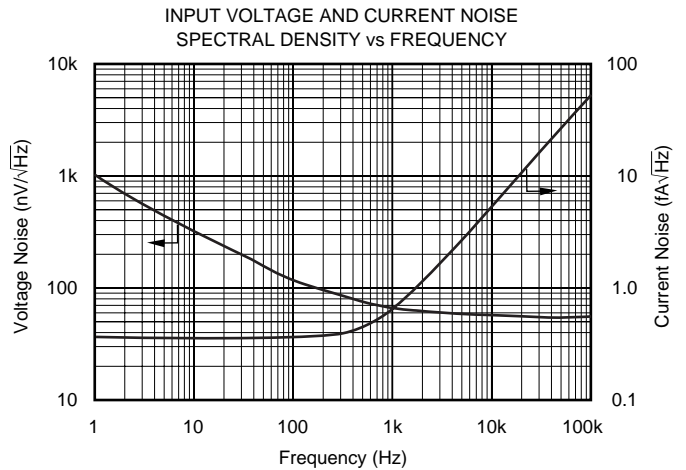
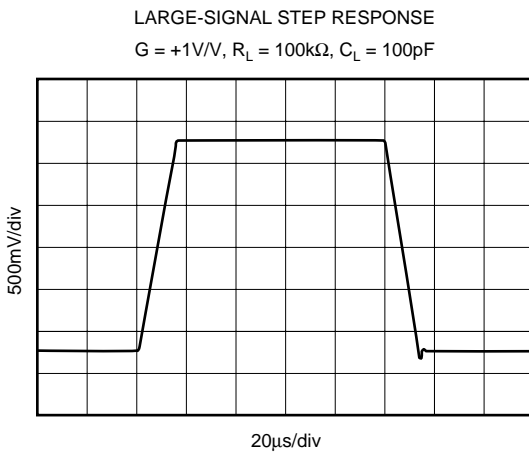
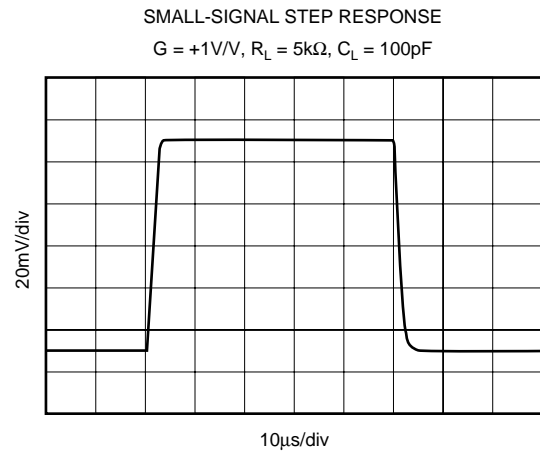
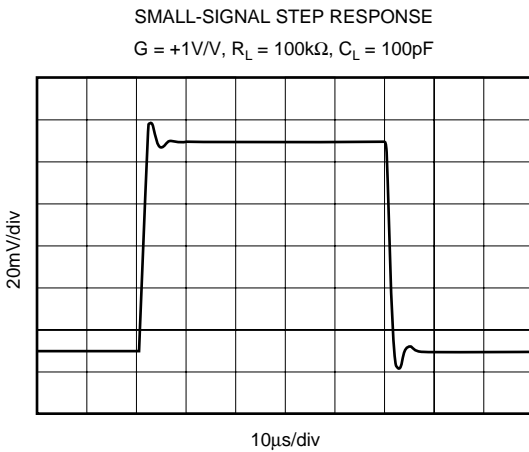
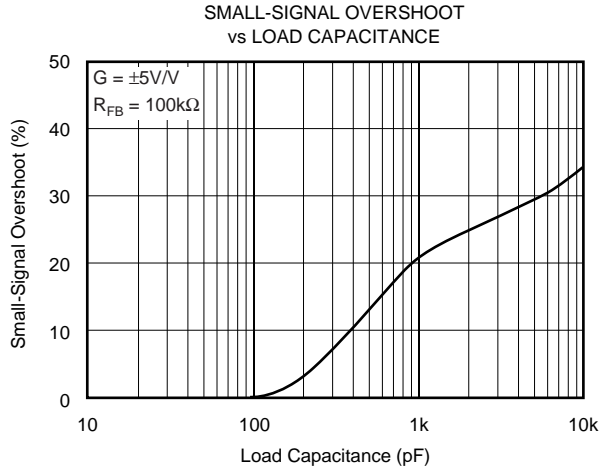
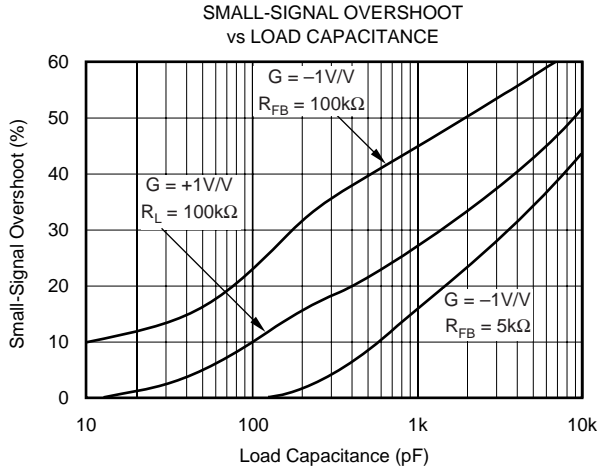

Package Dimension

SC70-5 (SOT353)

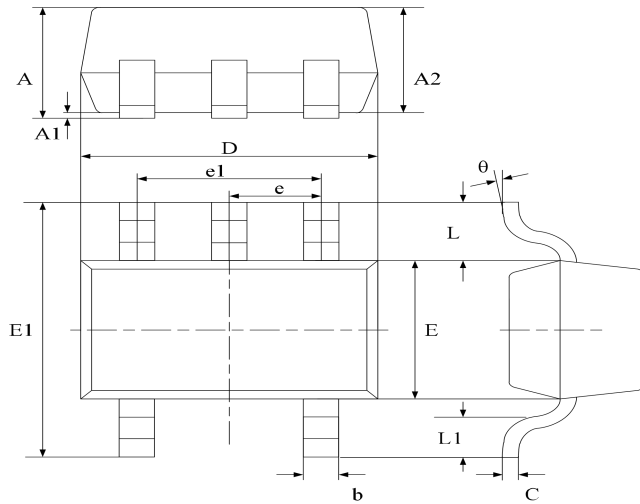

Symbol	Dimensions In Millimeters		Dimensions In Inches	
	Min	Max	Min	Max
A	0.800	1.100	0.035	0.043
A1	0.000	0.100	0.000	0.004
A2	0.800	0.900	0.035	0.039
b	0.150	0.350	0.006	0.014
C	0.080	0.150	0.003	0.006
D	1.8500	2.150	0.079	0.087
E	1.100	1.400	0.045	0.053
E1	1.950	2.200	0.085	0.096
e	0.850 typ.		0.026 typ.	
e1	1.200	1.400	0.047	0.055
L	0.42 ref.		0.021 ref.	
L1	0.260	0.460	0.010	0.018
theta	0°	8°	0°	8°

SOP-14

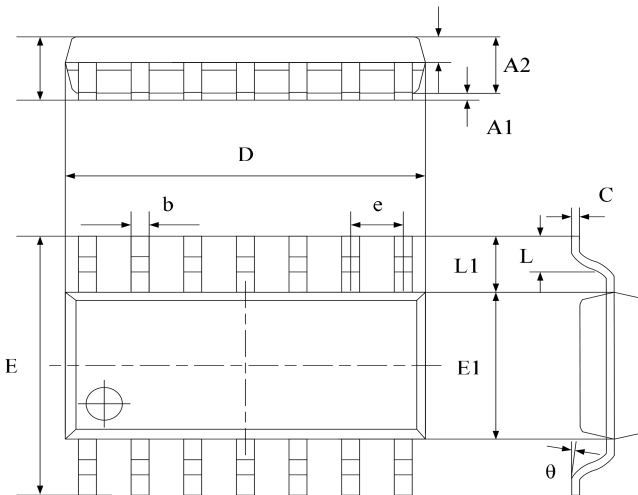

Symbol	Dimensions In Millimeters		Dimensions In Inches	
	Min	Max	Min	Max
A	1.450	1.850	0.059	0.076
A1	0.100	0.300	0.004	0.012
A2	1.350	1.550	0.055	0.063
A3	0.550	0.750	0.022	0.031
b	0.406typ.		0.017typ.	
C	0.203typ.		0.008typ.	
D	8.630	8.830	0.352	0.360
E	5.840	6.240	0.238	0.255
E1	3.850	4.050	0.157	0.165
e	1.270 typ.		0.050 typ.	
L1	1.040 ref.		0.041 ref.	
L	0.350	0.750	0.014	0.031
theta	2°	8°	2°	8°

SOP-8

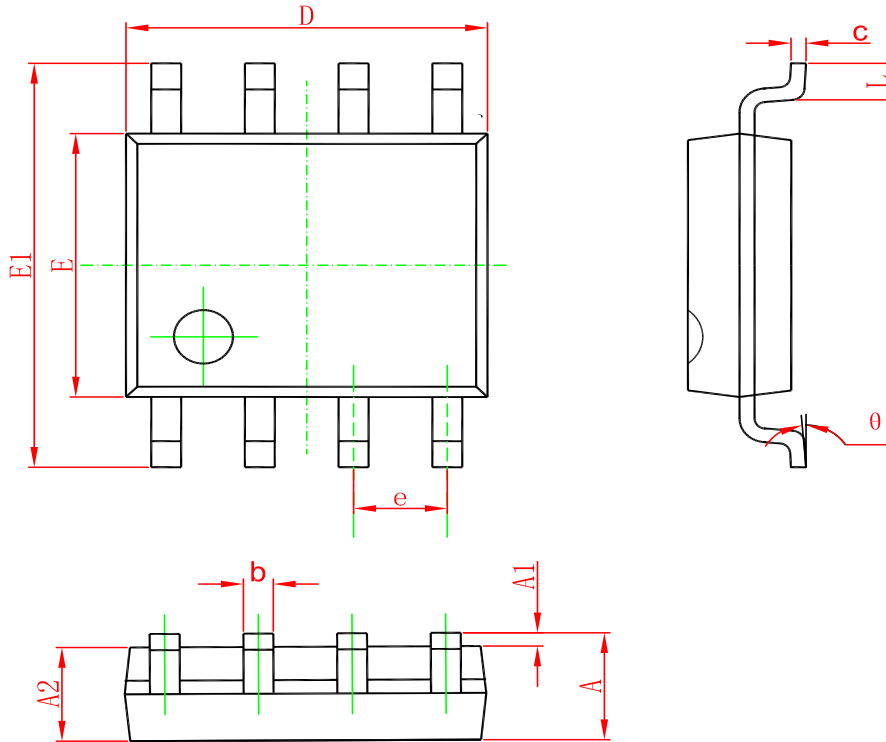

Symbol	Dimensions In Millimeters		Dimensions In Inches	
	Min	Max	Min	Max
A	1.350	1.750	0.053	0.069
A1	0.100	0.250	0.004	0.010
A2	1.350	1.550	0.053	0.061
b	0.330	0.510	0.013	0.020
c	0.170	0.250	0.006	0.010
D	4.700	5.100	0.185	0.200
E	3.800	4.000	0.150	0.157
E1	5.800	6.200	0.228	0.244
e	1.270(BSC)		0.050(BSC)	
L	0.400	1.270	0.016	0.050
θ	0°	8°	0°	8°

TSSOP-14

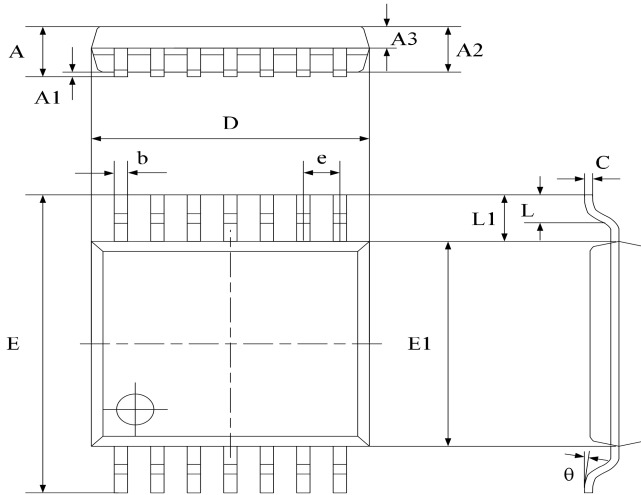

Symbol	Dimensions In Millimeters		Dimensions In Inches	
	Min	Max	Min	Max
A	-	1.200	-	0.0472
A1	0.050	0.150	0.002	0.006
A2	0.900	1.050	0.037	0.043
A3	0.390	0.490	0.016	0.020
b	0.200	0.290	0.008	0.012
C	0.130	0.180	0.005	0.007
D	4.860	5.060	0.198	0.207
E	6.200	6.600	0.253	0.269
E1	4.300	4.500	0.176	0.184
e	0.650 typ.		0.0256 typ.	
L1	1.000 ref.		0.0393 ref.	
L	0.450	0.750	0.018	0.031
θ	0°	8°	0°	8°

Ordering information

Order code	Package	Baseqty	Deliverymode	Marking
UMW OPA347SA	SC70-5	3000	Tape and reel	S47 U
UMW OPA4347UA	SOP-14	2500	Tape and reel	OPA4347UA
UMW OPA2347UA	SOP-8	2500	Tape and reel	OPA2347UA
UMW OPA4347EA	TSSOP-14	4000	Tape and reel	OPA4347EA



## X-ON Electronics

Largest Supplier of Electrical and Electronic Components

*Click to view similar products for [Operational Amplifiers - Op Amps](#) category:*

*Click to view products by [Youtai](#) manufacturer:*

Other Similar products are found below :

[430227FB](#) [LT1678IS8](#) [NCV33202DMR2G](#) [NJM324E](#) [M38510/13101BPA](#) [NTE925](#) [AZV358MTR-G1](#) [AP4310AUMTR-AG1](#)  
[AZV358MMTR-G1](#) [SCY33178DR2G](#) [NCV20034DR2G](#) [NTE778S](#) [NTE871](#) [NTE937](#) [NJU7057RB1-TE2](#) [SCY6358ADR2G](#)  
[NJM2904CRB1-TE1](#) [UPC4570G2-E1-A](#) [UPC4741G2-E1-A](#) [UPC4574GR-9LG-E1-A](#) [NJM8532RB1-TE1](#) [EL2250CS](#) [EL5100IS](#) [EL5104IS](#)  
[EL5127CY](#) [EL5127CYZ](#) [EL5133IW](#) [EL5152IS](#) [EL5156IS](#) [EL5162IS](#) [EL5202IY](#) [EL5203IY](#) [EL5204IY](#) [EL5210CS](#) [EL5210CYZ](#)  
[EL5211IYE](#) [EL5220CY](#) [EL5223CLZ](#) [EL5223CR](#) [EL5224ILZ](#) [EL5227CLZ](#) [EL5227CRZ](#) [EL5244CS](#) [EL5246CS](#) [EL5246CSZ](#) [EL5250IY](#)  
[EL5251IS](#) [EL5257IS](#) [EL5260IY](#) [EL5261IS](#)