

## Product profile

### General description

PESD1LIN in a very small SOD323 (SC-76) Surface-Mounted Device (SMD) plastic package designed to protect one automotive Local Interconnect Network (LIN) bus line from the damage caused by ElectroStatic Discharge (ESD) and other transients.

### Features and benefits

- ESD protection of one automotive LIN-bus line
- Asymmetrical diode configuration ensures an optimized protection against ElectroMagnetic Interferences (EMI) of a LIN Electronic Control Unit (ECU)
- Max. peak pulse power:  $P_{PP} = 160 \text{ W}$  at  $t_p = 8/20 \mu\text{s}$
- Low clamping voltage:  $V_{CL} = 40 \text{ V}$  at  $I_{PP} = 1 \text{ A}$
- Ultra low leakage current:  $I_{RM} < 1 \text{ nA}$
- ESD protection of up to 23 kV
- IEC 61000-4-2, level 4 (ESD)
- IEC 61000-4-5 (surge);  $I_{PP} = 3 \text{ A}$  at  $t_p = 8/20 \mu\text{s}$
- AEC-Q101 qualified

### Applications

- LIN-bus protection
- Automotive applications

### Quick reference data

**Table 1. Quick reference data**  
*T<sub>amb</sub> = 25 °C unless otherwise specified.*

Symbol	Parameter	Conditions	Min	Typ	Max	Unit
$V_{RWM}$	reverse standoff voltage					
	PESD1LIN (15 V)		-	-	15	V
	PESD1LIN (24 V)		-	-	24	V
$C_d$	diode capacitance	$V_R = 0 \text{ V};$ $f = 1 \text{ MHz}$	-	13	17	pF

## Pinning information

**Table 2. Pinning**

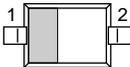
Pin	Description	Simplified outline	Graphic symbol
1	cathode 1 (15 V)		
2	cathode 2 (24 V)		

## Limiting values

**Table 3. Limiting values**

In accordance with the Absolute Maximum Rating System (IEC 60134).

Symbol	Parameter	Conditions	Min	Max	Unit
P <sub>PP</sub>	peak pulse power	t <sub>p</sub> = 8/20 μs	[1] -	160	W
I <sub>PP</sub>	peak pulse current	t <sub>p</sub> = 8/20 μs	[1] -	3	A
T <sub>j</sub>	junction temperature		-	150	°C
T <sub>amb</sub>	ambient temperature		-65	+150	°C
T <sub>stg</sub>	storage temperature		-65	+150	°C

[1] Non-repetitive current pulse 8/20 μs exponential decay waveform according to IEC 61000-4-5.

**Table 4. ESD maximum ratings**

Symbol	Parameter	Conditions	Min	Max	Unit
V <sub>ESD</sub>	electrostatic discharge voltage	IEC 61000-4-2 (contact discharge)	[1] -	23	kV
		MIL-STD-883 (human body model)	-	10	kV

[1] Device stressed with ten non-repetitive ESD pulses.

**Table 5. ESD standards compliance**

Standard	Conditions
IEC 61000-4-2; level 4 (ESD)	> 15 kV (air); > 8 kV (contact)
MIL-STD-883; class 3 (human body model)	> 4 kV

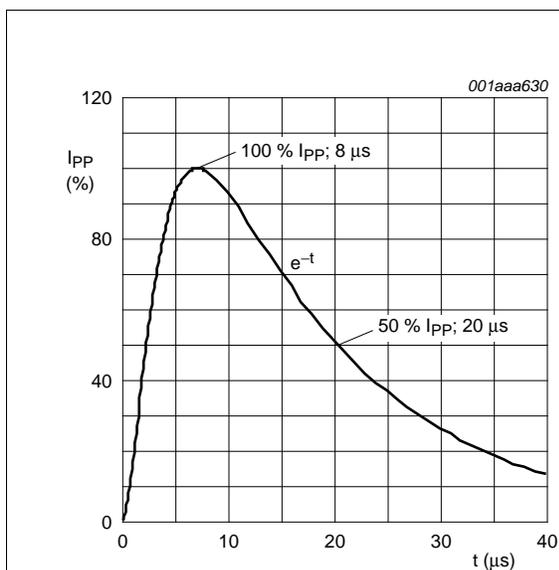

**Fig 1. 8/20 μs pulse waveform according to IEC 61000-4-5**

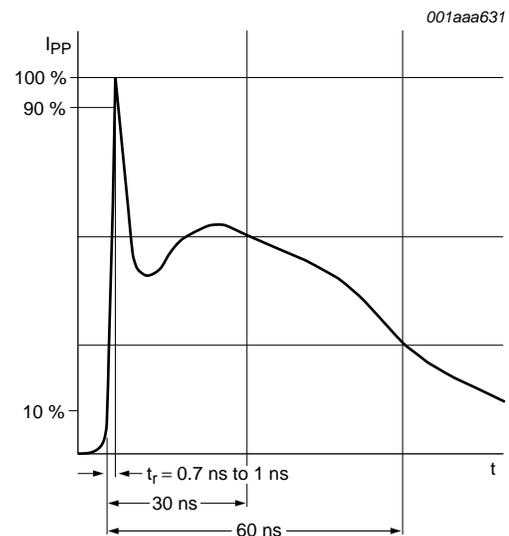

**Fig 2. ESD pulse waveform according to IEC 61000-4-2**

## Characteristics

**Table 6. Characteristics**  
*T<sub>amb</sub> = 25 °C unless otherwise specified.*

Symbol	Parameter	Conditions	Min	Typ	Max	Unit
V <sub>RWM</sub>	reverse standoff voltage					
	PESD1LIN (15 V)		-	-	15	V
	PESD1LIN (24 V)		-	-	24	V
I <sub>RM</sub>	reverse leakage current					
	PESD1LIN (15 V)	V <sub>RWM</sub> = 15 V	-	< 1	50	nA
	PESD1LIN (24 V)	V <sub>RWM</sub> = 24 V	-	< 1	50	nA
V <sub>BR</sub>	breakdown voltage	I <sub>R</sub> = 5 mA				
	PESD1LIN (15 V)		17.1	18.9	20.3	V
	PESD1LIN (24 V)		25.4	27.8	30.3	V
C <sub>d</sub>	diode capacitance	V <sub>R</sub> = 0 V; f = 1 MHz	-	13	17	pF
V <sub>CL</sub>	clamping voltage		[1]			
	PESD1LIN (15 V)	I <sub>PP</sub> = 1 A	-	-	25	V
		I <sub>PP</sub> = 5 A	-	-	44	V
	PESD1LIN (24 V)	I <sub>PP</sub> = 1 A	-	-	40	V
		I <sub>PP</sub> = 3 A	-	-	70	V
r <sub>dif</sub>	differential resistance					
	PESD1LIN (15 V)	I <sub>R</sub> = 1 mA	-	-	225	Ω
	PESD1LIN (24 V)	I <sub>R</sub> = 1 mA	-	-	300	Ω

[1] Non-repetitive current pulse 8/20 μs exponential decay waveform according to IEC 61000-4-5.

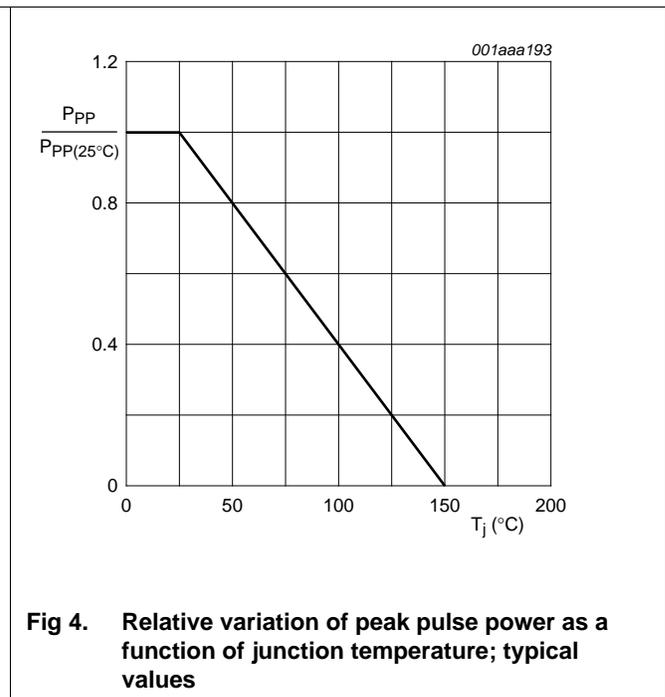
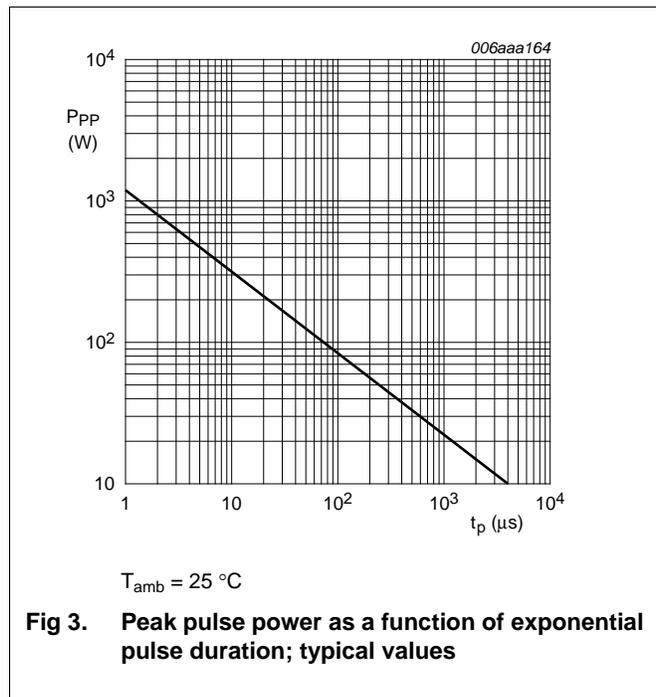

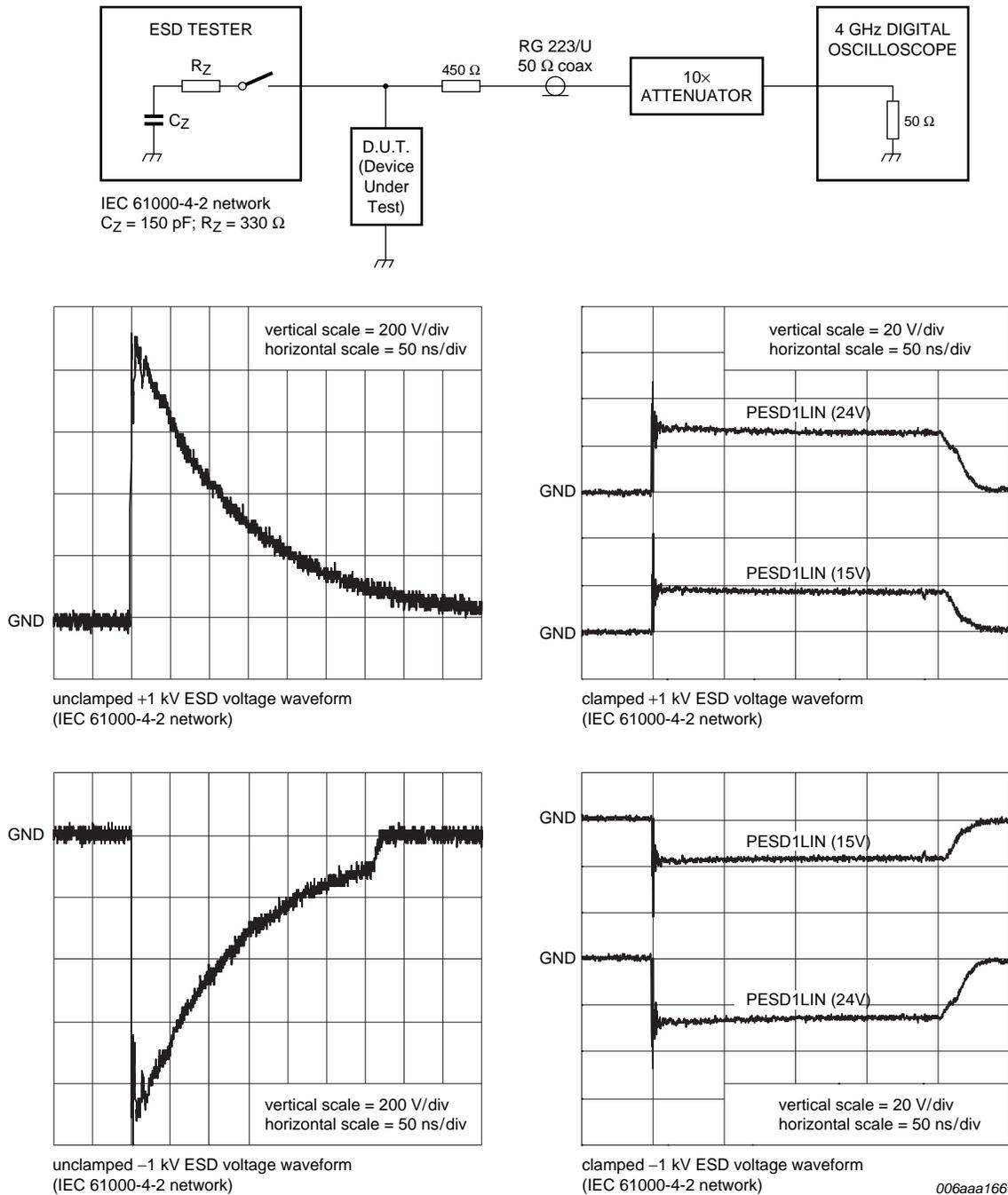

Fig 5. ESD clamping test setup and waveforms

## Application information

The PESD1LIN is designed for the protection of one LIN-bus signal line from the damage caused by ESD and surge pulses. The PESD1LIN provides a surge capability of up to 160 W per line for a 8/20  $\mu$ s waveform.

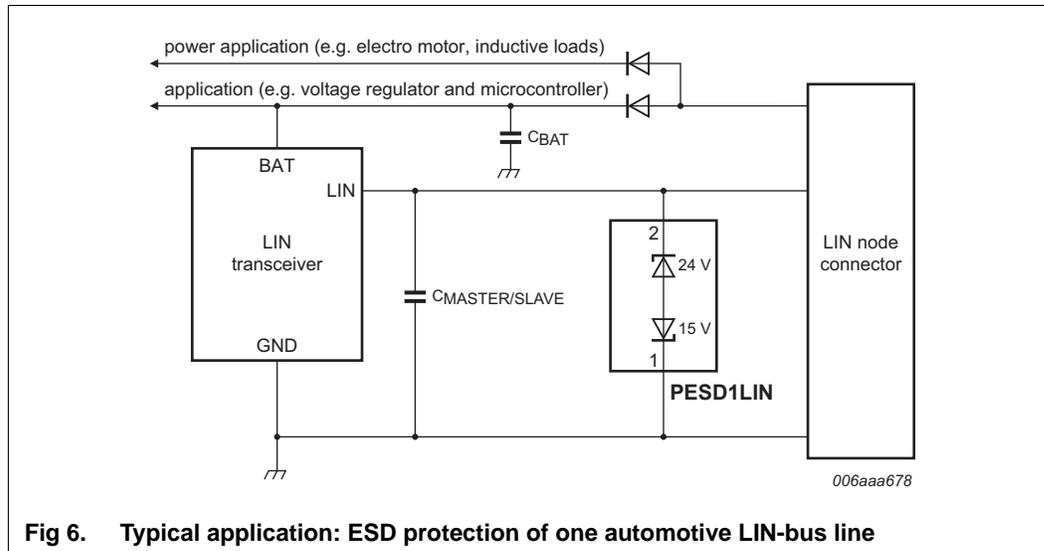

Fig 6. Typical application: ESD protection of one automotive LIN-bus line

### Circuit board layout and protection device placement

Circuit board layout is critical for the suppression of ESD, Electrical Fast Transient (EFT) and surge transients. The following guidelines are recommended:

1. Place the PESD1LIN as close to the input terminal or connector as possible.
2. The path length between the PESD1LIN and the protected line should be minimized.
3. Keep parallel signal paths to a minimum.
4. Avoid running protection conductors in parallel with unprotected conductor.
5. Minimize all Printed-Circuit Board (PCB) conductive loops including power and ground loops.
6. Minimize the length of the transient return path to ground.
7. Avoid using shared transient return paths to a common ground point.
8. Ground planes should be used whenever possible. For multilayer PCBs, use ground vias.

## Test information

### Quality information

This product has been qualified in accordance with the Automotive Electronics Council (AEC) standard *Q101 - Stress test qualification for discrete semiconductors*, and is suitable for use in automotive applications.

### Package outline

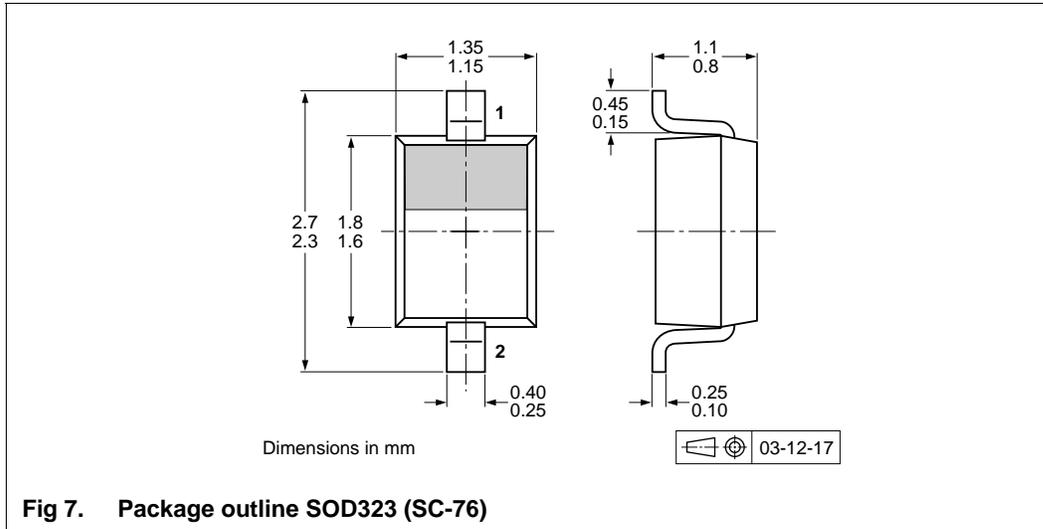

Fig 7. Package outline SOD323 (SC-76)

### Soldering

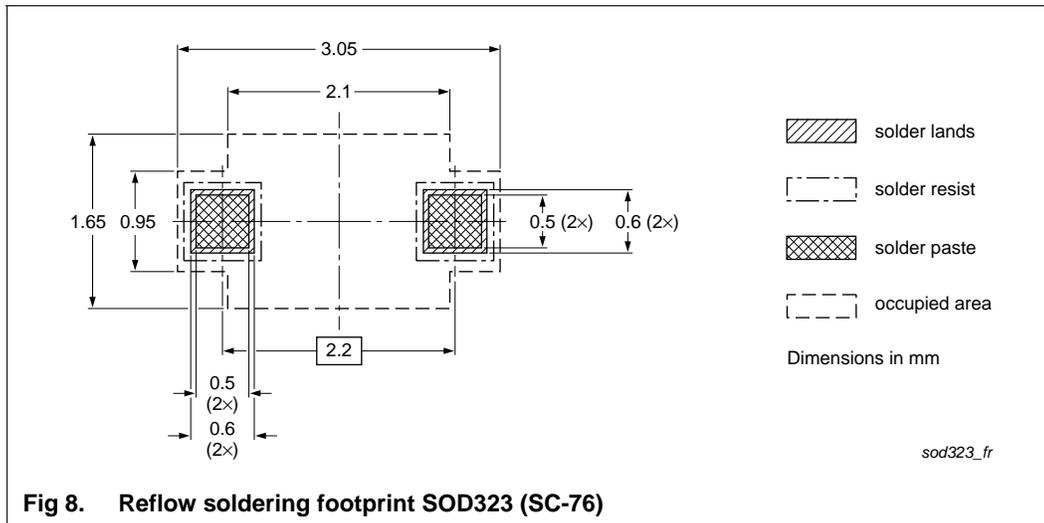

Fig 8. Reflow soldering footprint SOD323 (SC-76)

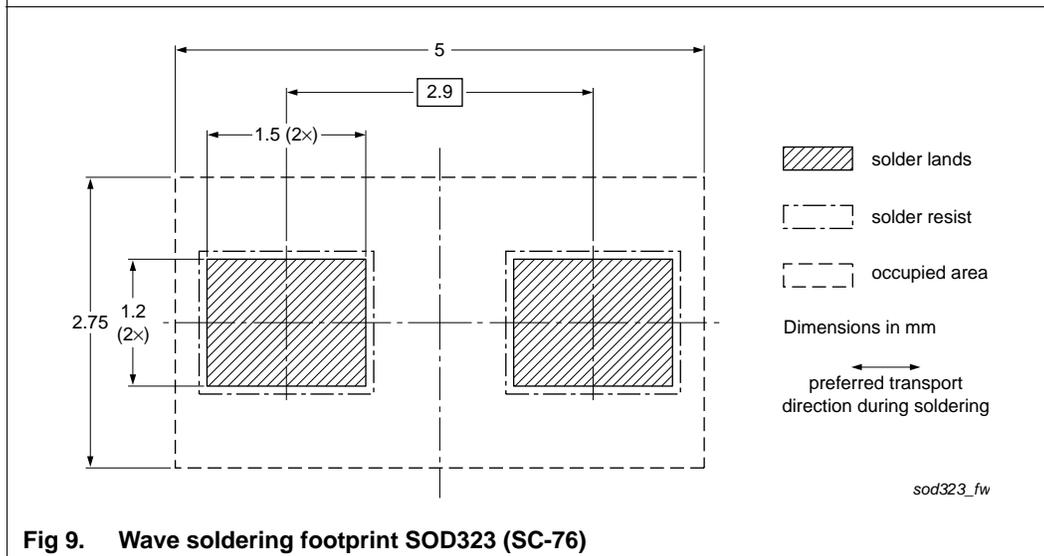

Fig 9. Wave soldering footprint SOD323 (SC-76)

## Marking



## Ordering information

Order code	Package	Base qty	Delivery mode
UMW PESD1LIN	SOD-323	3000	Tape and reel

## X-ON Electronics

Largest Supplier of Electrical and Electronic Components

*Click to view similar products for [ESD Suppressors / TVS Diodes](#) category:*

*Click to view products by [Youtai](#) manufacturer:*

Other Similar products are found below :

[60KS200C](#) [D18V0L1B2LP-7B](#) [D5V0F4U5P5-7](#) [NTE4902](#) [P4KE27CA](#) [P6KE11CA](#) [P6KE39CA-TP](#) [P6KE8.2A](#) [JANTX1N6053A](#)  
[SA110CA](#) [SA60CA](#) [SA64CA](#) [SMBJ12CATR](#) [SMBJ33CATR](#) [SMBJ8.0A](#) [ESD101-B1-02ELS E6327](#) [ESD105-B1-02EL E6327](#) [ESD112-B1-02EL E6327](#) [ESD119B1W01005E6327XTSA1](#) [ESD5V0L1B02VH6327XTSA1](#) [ESD7451N2T5G](#) [19180-510](#) [CPDT-5V0USP-HF](#)  
[3.0SMCJ33CA-F](#) [3.0SMCJ36A-F](#) [HSPC16701B02TP](#) [JANTX1N6126A](#) [JANTX1N6462](#) [JANTX1N6465](#) [USB50805e3/TR7](#)  
[D3V3Q1B2DLP3-7](#) [D55V0M1B2WS-7](#) [DRTR5V0U4SL-7](#) [SCM1293A-04SO](#) [ESD200-B1-CSP0201 E6327](#) [SM12-7](#) [SM1605E3/TR13](#)  
[SMLJ45CA-TP](#) [CEN955 W/DATA](#) [82350120560](#) [VESD12A1A-HD1-GS08](#) [CPDUR5V0R-HF](#) [CPDQC5V0U-HF](#) [CPDQC5V0USP-HF](#)  
[CPDQC5V0-HF](#) [D1213A-01LP4-7B](#) [ESD101-B1-02EL E6327](#) [824500181](#) [MMAD1108/TR13](#) [5KP100A](#)