

### Features

- 300 W peak pulse power ( $t_p = 8/20\mu s$ )
- Bidirectional and unidirectional configurations
- Solid-state silicon-avalanche technology
- Low clamping voltage
- Low leakage current
- Low capacitance ( $C_j = 120$  pF typ.)
- Protection two data lines
- IEC 61000-4-2  $\pm 30$ kV contact  $\pm 30$ kV air
- IEC 61000-4-4 (EFT) 40A(5/50ns)
- IEC 61000-4-5 (Lightning) 20A(8/20 $\mu s$ )

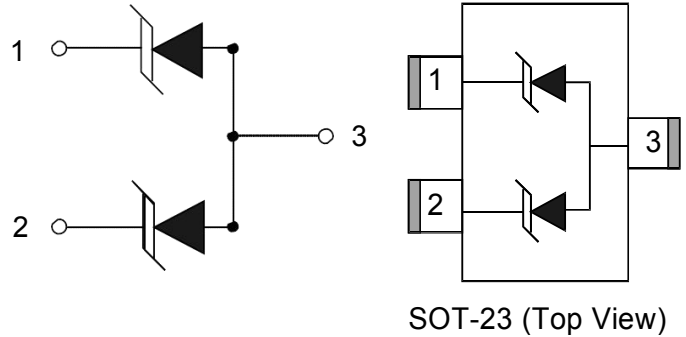

### Applications

- Dataline
- Automatic Teller Machines
- Net works
- Power line

### Mechanical Data

- SOT-23 package
- Molding compound flammability rating: UL 94V-0
- Packaging: Tape and Reel
- RoHS/WEEE Compliant

### Absolute Maximum Rating

Rating	Symbol	Value	Units
Peak Pulse Power ( $t_p = 8/20\mu s$ )	$P_{pp}$	300	W
Peak Pulse Current ( $t_p = 8/20\mu s$ )(note1)	$I_{pp}$	20	A
ESD per IEC 61000-4-2(Air) ESD per IEC 61000-4-2(Contact)	$V_{ESD}$	30 30	kV
Lead Soldering Temperature	$T_L$	260	°C
Junction Temperature	$T_J$	-55 to + 125	°C
Storage Temperature	$T_{stg}$	-55 to + 125	°C

**Electrical Characteristics**

Parameter	Symbol	Conditions	Min	Typical	Max	Units
Reverse Stand-Off Voltage	$V_{RWM}$				5	V
Reverse Breakdown Voltage	$V_{BR}$	$I_T=1mA$	6.0	7.0	8.5	V
Reverse Leakage Current	$I_R$	$V_{RWM}=5V, T=25^{\circ}C$		0.5	1	$\mu A$
Peak Pulse Current	$I_{PP}$	$t_p=8/20\mu s$			20	A
Clamping Voltage	$V_C$	$I_{PP}=10A, t_p=8/20\mu s$			12	V
		$I_{PP}=20A, t_p=8/20\mu s$			16	V
Junction Capacitance	$C_j$	$V_R = 0V, f = 1MHz$ (pin1 \cdot pin2 to pin3)		120		pF

**Electrical Parameters (TA = 25°C unless otherwise noted)**

Symbol	Parameter
$I_{PP}$	Maximum Reverse Peak Pulse Current
$V_C$	Clamping Voltage @ $I_{PP}$
$V_{RWM}$	Working Peak Reverse Voltage
$I_R$	Maximum Reverse Leakage Current @ $V_{RWM}$
$V_{BR}$	Breakdown Voltage @ $I_T$
$I_T$	Test Current

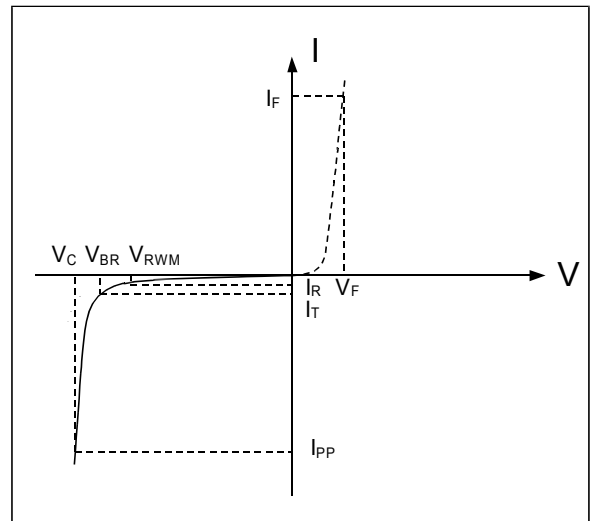

Note: 8/20 $\mu s$  pulse waveform.

## Typical Characteristics

Figure 1: Peak Pulse Power vs. Pulse Time

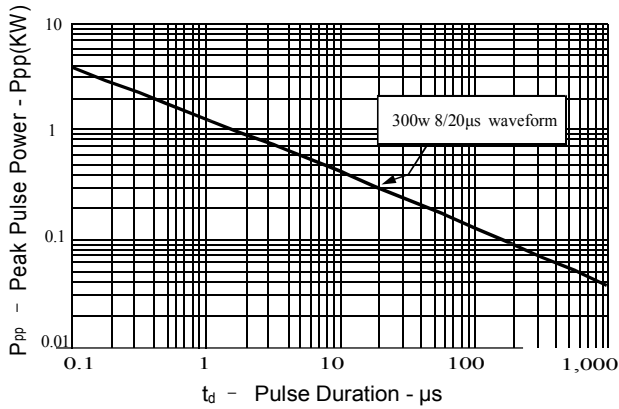

Figure 2: Power Derating Curve

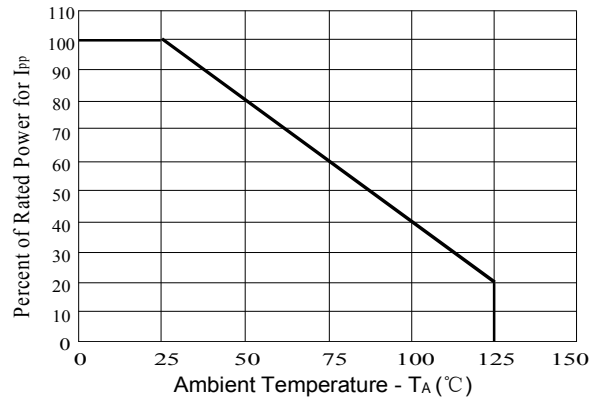

Figure 3: Pulse Waveform

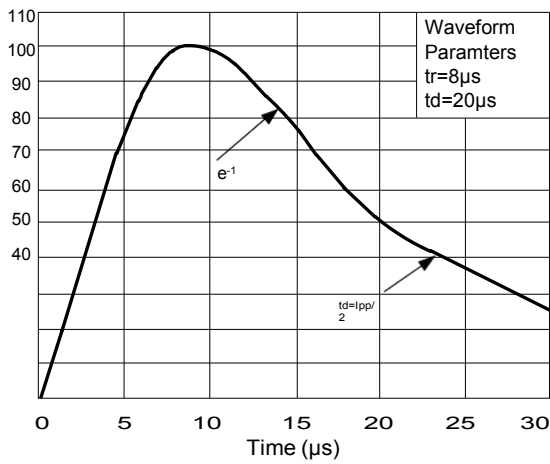
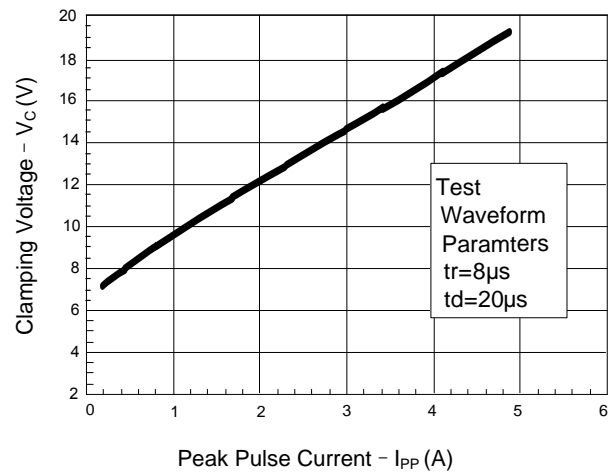
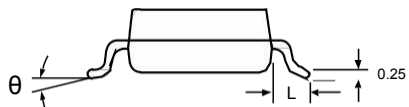
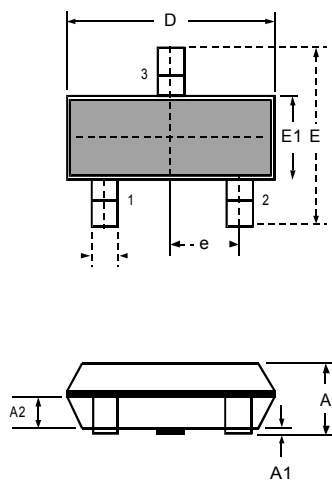

Figure 4: Clamping Voltage vs. I<sub>pp</sub>



### Outline Drawing – SOT-23



#### DIMENSIONS

SYMBOL	MILLIMETER		INCHES	
	MIN	MAX	MIN	MAX
A	0.900	1.150	0.035	0.045
A1	0.000	0.100	0.000	0.004
A2	0.900	1.050	0.035	0.041
D	2.800	3.000	0.110	0.118
b	0.300	0.500	0.012	0.020
E	2.250	2.550	0.089	0.100
E1	1.200	1.400	0.047	0.055
e	0.950 BSC		0.037 BSC	
L	0.300	0.500	0.012	0.020
$\theta$	0	8°	0	8°

### Marking

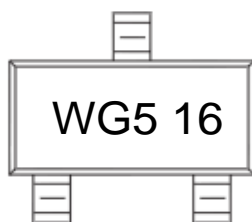

### Ordering information

Order code	Package	Base qty	Delivery mode
UMW PESD5V0S2BT	SOT-23	3000	Tape and reel

## X-ON Electronics

Largest Supplier of Electrical and Electronic Components

*Click to view similar products for [ESD Suppressors / TVS Diodes](#) category:*

*Click to view products by [Youtai](#) manufacturer:*

Other Similar products are found below :

[60KS200C](#) [D18V0L1B2LP-7B](#) [D5V0F4U5P5-7](#) [NTE4902](#) [P4KE27CA](#) [P6KE11CA](#) [P6KE39CA-TP](#) [P6KE8.2A](#) [JANTX1N6053A](#)  
[SA110CA](#) [SA60CA](#) [SA64CA](#) [SMBJ12CATR](#) [SMBJ33CATR](#) [SMBJ8.0A](#) [ESD101-B1-02ELS E6327](#) [ESD105-B1-02EL E6327](#) [ESD112-B1-02EL E6327](#) [ESD119B1W01005E6327XTSA1](#) [ESD5V0L1B02VH6327XTSA1](#) [ESD7451N2T5G](#) [19180-510](#) [CPDT-5V0USP-HF](#)  
[3.0SMCJ33CA-F](#) [3.0SMCJ36A-F](#) [HSPC16701B02TP](#) [JANTX1N6126A](#) [JANTX1N6462](#) [JANTX1N6465](#) [USB50805e3/TR7](#)  
[D3V3Q1B2DLP3-7](#) [D55V0M1B2WS-7](#) [DRTR5V0U4SL-7](#) [SCM1293A-04SO](#) [ESD200-B1-CSP0201 E6327](#) [SM12-7](#) [SM1605E3/TR13](#)  
[SMLJ45CA-TP](#) [CEN955 W/DATA](#) [82350120560](#) [VESD12A1A-HD1-GS08](#) [CPDUR5V0R-HF](#) [CPDQC5V0U-HF](#) [CPDQC5V0USP-HF](#)  
[CPDQC5V0-HF](#) [D1213A-01LP4-7B](#) [ESD101-B1-02EL E6327](#) [824500181](#) [MMAD1108/TR13](#) [5KP100A](#)