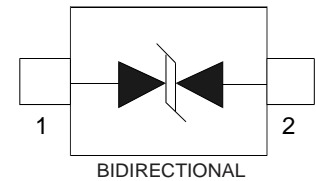
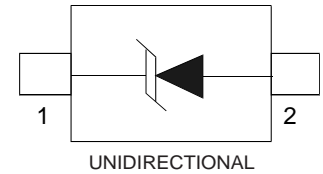


## DESCRIPTION

The PSDxx and PSDxxC Series are transient voltage suppressor arrays designed for ESD protection of SMART phones, laptop computers and other portable electronics. These silicon based diodes offer superior clamping voltage and performance compared to other technologies such as MLVs. The PSDxx and PSDxxC Series can be utilized as a single line protector in either a unidirectional or bidirectional configuration. The SOD-323 small package configuration offers designers the flexibility of placement on the printed circuit board for each I/O port or voltage bus. The PSDxx and PSDxxC Series meets the IEC 61000-4-2 (ESD), 61000-4-4 (EFT) and 61000-4-5 requirements.



## FEATURES

- Compatible with IEC 61000-4-2 (ESD): Air -15kV, Contact - 8kV
- Compatible with IEC 61000-4-4 (EFT): 40A -5/50ns
- Compatible with IEC 61000-4-5 (Surge): 24A, 8/20µs Level 2(Line-Gnd) & Level 3 (Line-Line)
- Unidirectional: 500W Peak Pulse Power per Line (tp = 8/20µs)
- Bidirectional: 400W Peak Pulse Power per Line (tp = 8/20µs)
- Replacement for MLV (0805)
- Unidirectional & Bidirectional Configurations
- Protects One Power or I/O Port
- ESD Protection > 25kV
- Low Clamping Voltage
- Available in Multiple Voltages Ranging From 3V to 36V
- RoHS Compliant
- REACH Compliant

## APPLICATIONS

- Laptop Computers
- SMART Phones
- Portable Electronics

## Mechanical Data

- Molded JEDEC SOD-323 Package
- Approximate Weight: 5 milligrams
- Lead-Free Pure-Tin Plating (Annealed)
- Solder Reflow Temperature: Pure-Tin - Sn, 100: 260-270°C
- 8mm Tape and Reel Per EIA Standard 481
- Flammability Rating UL 94V-0

## TYPICAL DEVICE CHARACTERISTICS

### MAXIMUM RATINGS @ 25°C Unless Otherwise Specified

PARAMETER	SYMBOL	VALUE	UNITS
Unidirectional: Peak Pulse Power (tp = 8/20µs) - See Figure 1	P <sub>PP</sub>	500	W
Bidirectional: Peak Pulse Power (tp = 8/20µs) - See Figure 1	P <sub>PP</sub>	400	W
Operating Temperature	T <sub>L</sub>	-55 to 150	°C
Storage Temperature	T <sub>STG</sub>	-55 to 150	°C

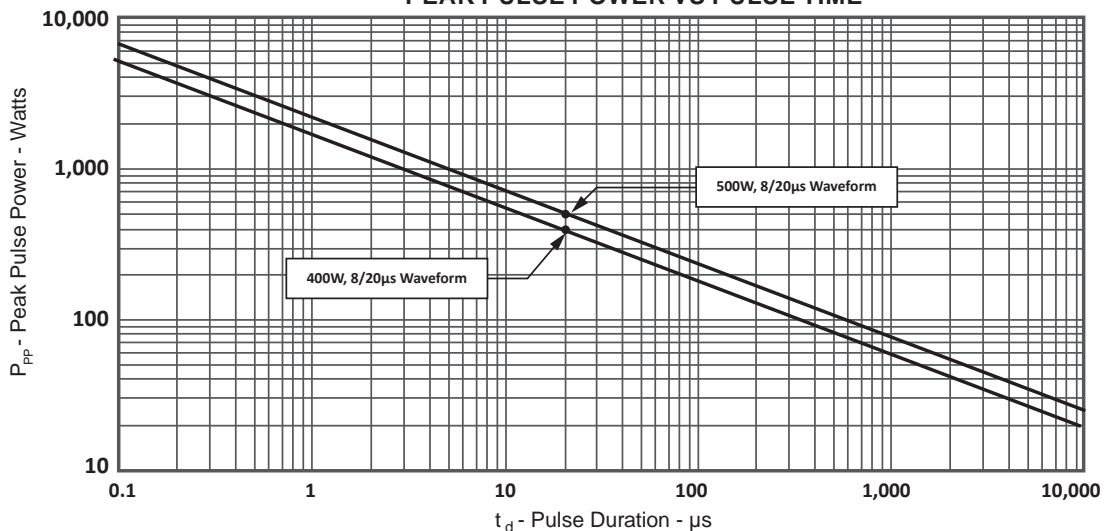
**ELECTRICAL CHARACTERISTICS PER LINE @ 25°C Unless Otherwise Specified**

PART NUMBER (Note 1)	RATED STAND-OFF VOLTAGE	MINIMUM BREAKDOWN VOLTAGE	MAXIMUM CLAMPING VOLTAGE (Fig 2)	MAXIMUM LEAKAGE CURRENT	TYPICAL CAPACITANCE
	$V_{WM}$ VOLTS	@ 1mA $V_{(BR)}$ VOLTS	@ $I_P = 1A$ $V_C$ VOLTS	@ $V_{WM}$ $I_D$ $\mu A$	@ 0V, 1MHz C pF
PSD03	3.3	4.0	6.5	125	500
PSD03C	3.3	4.0	7.0	125	200
PSD05	5.0	6.0	9.8	10	350
PSD05C	5.0	6.0	9.8	10	175
PSD08	8.0	8.5	13.4	10	250
PSD08C	8.0	8.5	13.4	10	150
PSD12	12.0	13.3	19.0	1	150
PSD12C	12.0	13.3	19.0	1	50
PSD15	15.0	16.7	24.0	1	100
PSD15C	15.0	16.7	24.0	1	40
PSD18	18.0	20.0	29.0	1	90
PSD18C	18.0	20.0	29.0	1	40
PSD24	24.0	26.7	43.0	1	88
PSD24C	24.0	26.7	43.0	1	40
PSD36	36.0	40.0	60.0	1	75
PSD36C	36.0	40.0	60.0	1	35

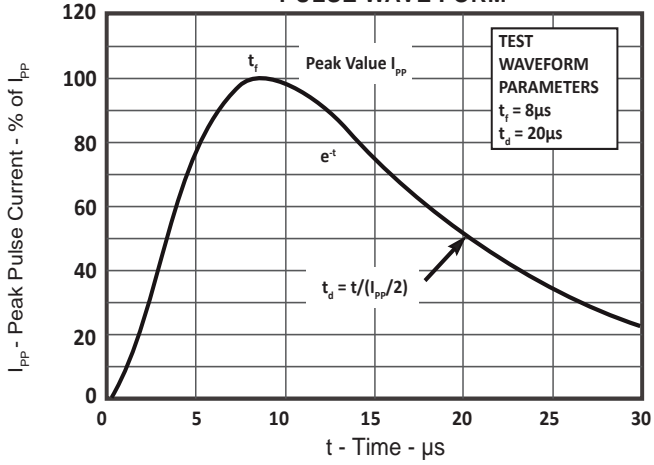
1. Part numbers with an additional "C" suffix are bidirectional devices, i.e., PSD05 C.

**TYPICAL DEVICE CHARACTERISTICS**

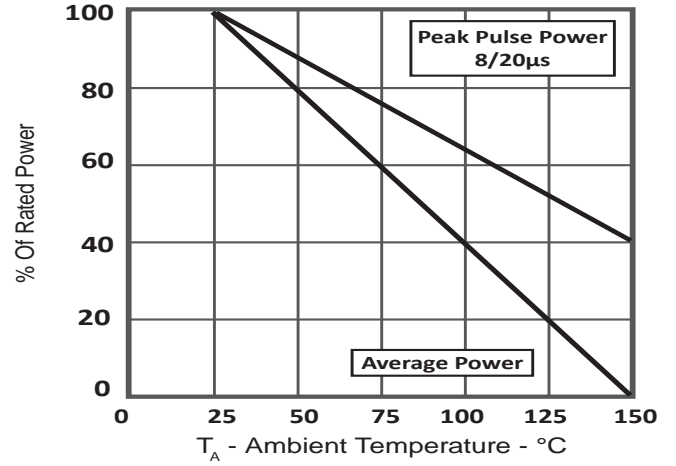
**FIGURE 1  
PEAK PULSE POWER VS PULSE TIME**



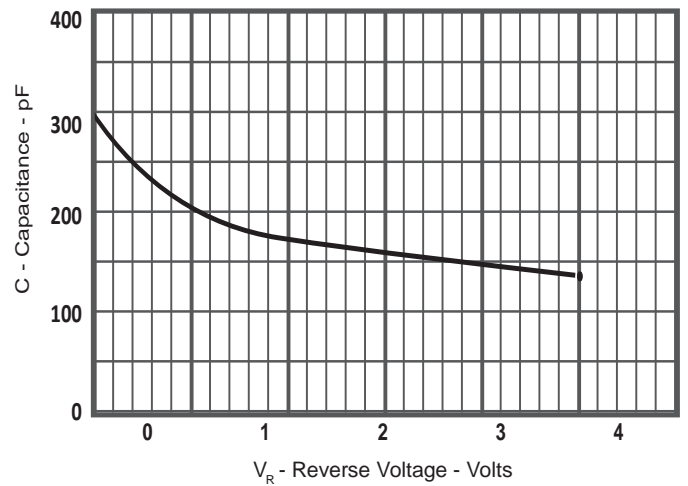
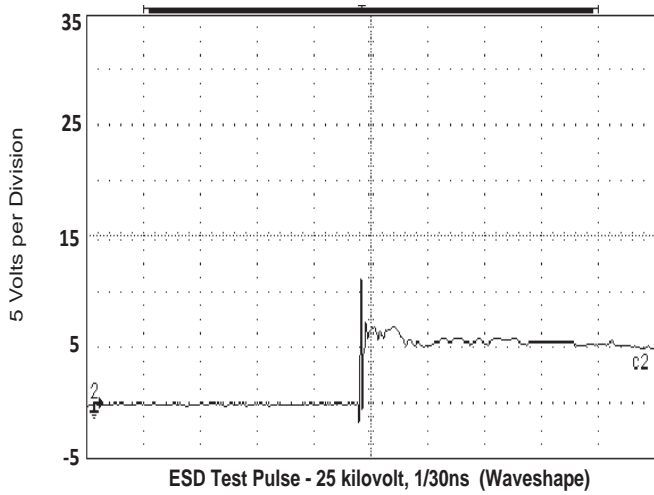
**FIGURE 2  
PULSE WAVE FORM**



**FIGURE 3  
POWER DERATING CURVE**

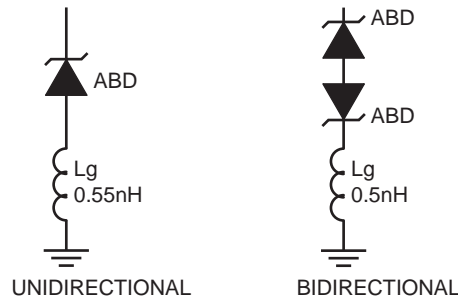


**FIGURE 4  
OVERSHOOT & CLAMPING VOLTAGE FOR PSD03**



**SPICE MODEL**

**FIGURE 1  
SPICE MODEL FOR**

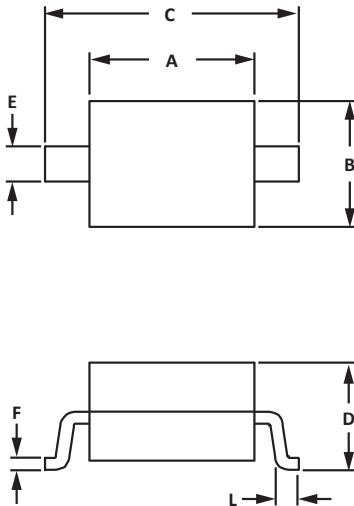


ABD - Avalanche Breakdown Diode (TVS)  
Lg - Lead Inductance

PARAMETER	UNIT	ABD(TVS)
BV	V	See Table 2
IBV	μA	1
C <sub>jo</sub>	pF	See Table 2
I <sub>s</sub>	A	See Table 2
V <sub>j</sub>	V	0.6
M	-	0.33
N	-	1
R <sub>s</sub>	Ohms	See Table 2
TT	s	1E-8
EG	eV	1.11

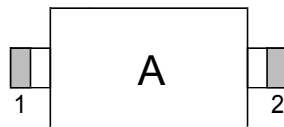
PART NUMBER	B <sub>v</sub> (VOLTS)	C <sub>jo</sub> (pF)	I <sub>s</sub> (AMPS)	R <sub>s</sub> (OHMS)
PSD03	4.0	438	1E-11	0.21
PSD05	6.0	284	1E-11	0.14
PSD08	8.5	146	1E-11	0.28
PSD12	13.3	123	1E-13	0.40
PSD15	16.7	102	1E-13	0.52
PSD24	26.7	61	1E-13	1.54
PSD03C	4.5	219	1E-11	0.21
PSD05C	6.0	142	1E-11	0.14
PSD08C	8.5	73	1E-11	0.28
PSD12C	13.3	62	1E-13	0.40
PSD15C	16.7	51	1E-13	0.52
PSD24C	26.7	30	1E-13	1.54

## Outline Drawing –SOD-323



DIM	OUTLINE DIMENSIONS			
	MILLIMETERS		INCHES	
	MIN	MAX	MIN	MAX
A	1.60	1.90	0.063	0.075
B	1.15	1.45	0.045	0.057
C	2.39	2.70	0.094	0.106
D	0.80	1.10	0.031	0.043
E	0.25	0.40	0.010	0.016
F	0.10	0.20	0.004	0.008
H	-	0.10	-	0.004
L	0.20	-	0.008	-

## Marking



## Ordering information

Order code	Marking code	Package	Baseqty	Deliverymode
UMW PSD03-LF-T7	A	SOD-323	3000	Tape and reel
UMW PSD03C-LF-T7	G	SOD-323	3000	Tape and reel
UMW PSD05-LF-T7	B	SOD-323	3000	Tape and reel
UMW PSD05C-LF-T7	H	SOD-323	3000	Tape and reel
UMW PSD08-LF-T7	C	SOD-323	3000	Tape and reel
UMW PSD08C-LF-T7	J	SOD-323	3000	Tape and reel
UMW PSD12-LF-T7	D	SOD-323	3000	Tape and reel
UMW PSD12C-LF-T7	K	SOD-323	3000	Tape and reel
UMW PSD15-LF-T7	E	SOD-323	3000	Tape and reel
UMW PSD15C-LF-T7	L	SOD-323	3000	Tape and reel
UMW PSD18-LF-T7	18	SOD-323	3000	Tape and reel
UMW PSD18C-LF-T7	N	SOD-323	3000	Tape and reel
UMW PSD24-LF-T7	F	SOD-323	3000	Tape and reel
UMW PSD24C-LF-T7	M	SOD-323	3000	Tape and reel
UMW PSD36-LF-T7	R	SOD-323	3000	Tape and reel
UMW PSD36C-LF-T7	T	SOD-323	3000	Tape and reel

## X-ON Electronics

Largest Supplier of Electrical and Electronic Components

*Click to view similar products for [ESD Suppressors / TVS Diodes](#) category:*

*Click to view products by [Youtai](#) manufacturer:*

Other Similar products are found below :

[60KS200C](#) [D18V0L1B2LP-7B](#) [D5V0F4U5P5-7](#) [NTE4902](#) [P4KE27CA](#) [P6KE11CA](#) [P6KE39CA-TP](#) [P6KE8.2A](#) [JANTX1N6053A](#)  
[SA110CA](#) [SA60CA](#) [SA64CA](#) [SMBJ12CATR](#) [SMBJ33CATR](#) [SMBJ8.0A](#) [ESD101-B1-02ELS E6327](#) [ESD105-B1-02EL E6327](#) [ESD112-B1-02EL E6327](#) [ESD119B1W01005E6327XTSA1](#) [ESD5V0L1B02VH6327XTSA1](#) [ESD7451N2T5G](#) [19180-510](#) [CPDT-5V0USP-HF](#)  
[3.0SMCJ33CA-F](#) [3.0SMCJ36A-F](#) [HSPC16701B02TP](#) [JANTX1N6126A](#) [JANTX1N6462](#) [JANTX1N6465](#) [USB50805e3/TR7](#)  
[D3V3Q1B2DLP3-7](#) [D55V0M1B2WS-7](#) [DRTR5V0U4SL-7](#) [SCM1293A-04SO](#) [ESD200-B1-CSP0201 E6327](#) [SM12-7](#) [SM1605E3/TR13](#)  
[SMLJ45CA-TP](#) [CEN955 W/DATA](#) [82350120560](#) [VESD12A1A-HD1-GS08](#) [CPDUR5V0R-HF](#) [CPDQC5V0U-HF](#) [CPDQC5V0USP-HF](#)  
[CPDQC5V0-HF](#) [D1213A-01LP4-7B](#) [ESD101-B1-02EL E6327](#) [824500181](#) [MMAD1108/TR13](#) [5KP100A](#)