

Features

- Low supply voltage: 1.5 V – 5.5 V
- Rail-to-rail input and output
- Low input offset voltage: 800 μ V max (A version)
- Low power consumption: 29 μ A typical
- Gain bandwidth product: 1.3 MHz typical
- Stable when used in gain configuration
- Micropackages: SOT23-5, SC70-5
- Low input bias current: 1 pA typical
- Extended temperature range: -40 to 125 $^{\circ}$ C
- 4 kV human body model

Description

The the TSV6291 are single operational amplifiers with a high bandwidth which consume only 29 μ A. They must be used in a gain configuration ($G < -3$, $G > 4$).

With a very low input bias current and low offset voltage (800 μ V maximum for the A version), the TSV629family of devices is ideal for applications requiring precision. The devices can operate at a power supply ranging from 1.5 to 5.5 V, and therefore suit battery-powered devices, extending battery life.

Applications

- Battery-powered applications
- Portable devices
- Signal conditioning
- Active filtering
- Medical instrumentation

Package pin connections

Package pin connections (top view)

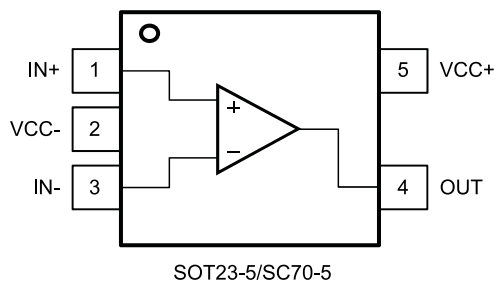

Absolute maximum ratings and operating conditions

Absolute maximum ratings (AMR)

Symbol	Parameter	Value	Unit
V _{CC}	Supply voltage ⁽¹⁾	6	V
V _{id}	Differential input voltage ⁽²⁾	±V _{CC}	
V _{in}	Input voltage ⁽³⁾	(V _{CC-}) - 0.2 to (V _{CC+}) + 0.2	
I _{in}	Input current ⁽⁴⁾	10	mA
$\overline{\text{SHDN}}$	Shutdown voltage ⁽³⁾	(V _{CC-}) - 0.2 to (V _{CC+}) + 0.2	V
T _{stg}	Storage temperature	-65 to 150	°C
T _j	Maximum junction temperature	150	
R _{thja}	Thermal resistance junction-to-ambient ⁽⁵⁾⁽⁶⁾	SOT23-5 250 SC70-5 205	°C/W

⁽¹⁾All voltage values, except differential voltage, are with respect to network ground terminal.

⁽²⁾Differential voltages are the non-inverting input terminal with respect to the inverting input terminal.

⁽³⁾V_{CC} - V_{in} must not exceed 6 V, V_{in} must not exceed 6 V.

⁽⁴⁾Input current must be limited by a resistor in series with the inputs.

⁽⁵⁾R_{th} are typical values.

⁽⁶⁾Short-circuits can cause excessive heating and destructive dissipation.

⁽⁷⁾Human body model: 100 pF discharged through a 1.5 kΩ resistor between two pins of the device, done for all couples of pin combinations with other pins floating.

⁽⁸⁾Machine mode: a 200 pF capacitor is charged to the specified voltage, then discharged directly between two pins of the device with no external series resistor (internal resistor < 5 Ω), done for all couples of pin combinations with other pins floating.

⁽⁹⁾Charged device model: all pins plus package are charged together to the specified voltage and then discharged directly to the ground.

Operating conditions

Symbol	Parameter	Value	Unit
V _{CC}	Supply voltage	1.5 to 5.5	V
V _{icm}	Common mode input voltage range	(V _{CC-}) - 0.1 to (V _{CC+}) + 0.1	
T _{oper}	Operating free air temperature range	-40 to 125	°C

Electrical characteristics

Electrical characteristics at (VCC+) = 1.8 V with (VCC-) = 0 V, Vicm = VCC/2, Tamb = 25 °C, and RL connected to VCC/2 (unless otherwise specified)

Symbol	Parameter	Conditions	Min.	Typ.	Max.	Unit
V _{io}	Offset voltage	TSV6291			4	mV
		TSV6291A			0.8	
		T _{min} < T _{op} < T _{max} , TSV6291			6	
		T _{min} < T _{op} < T _{max} , TSV6291A			2	
DV _{io}	Input offset voltage drift			2		μV/°C
I _{io}	Input offset current, V _{out} = V _{CC} /2 ⁽¹⁾	T _{min} < T _{op} < T _{max}		1	10	pA
				1	100	
I _{ib}	Input bias current, V _{out} = V _{CC} /2 ⁽¹⁾	T _{min} < T _{op} < T _{max}		1	10	pA
				1	100	
CMR	Common mode rejection ratio, 20 log (ΔV _{ic} /ΔV _{io})	0 V to 1.8 V, V _{out} = 0.9 V	53	74		dB
		T _{min} < T _{op} < T _{max}	51			
A _{vd}	Large signal voltage gain	R _L = 10 kΩ, V _{out} = 0.5 V to 1.3 V	78	95		dB
		T _{min} < T _{op} < T _{max}	73			
V _{OH}	High-level output voltage, V _{OH} = V _{CC} - V _{out}	R _L = 10 kΩ		5	35	mV
		T _{min} < T _{op} < T _{max}			50	
V _{OL}	Low-level output voltage	R _L = 10 kΩ		4	35	mV
		T _{min} < T _{op} < T _{max}			50	
I _{out}	Isink	V _{out} = 1.8 V	6	12		mA
		T _{min} < T _{op} < T _{max}	4			
	Isource	V _{out} = 0 V	6	10		
		T _{min} < T _{op} < T _{max}	4			
I _{CC}	Supply current (per operator)	No load, V _{out} = V _{CC} /2		25	31	μA
		T _{min} < T _{op} < T _{max}			33	
GBP	Gain bandwidth product	R _L = 10 kΩ, C _L = 100 pF		1.1		MHz
Gain	Minimum gain for stability	Phase margin = 60°, R _f = 10 kΩ, R _L = 10 kΩ, C _L = 20 pF		4		V/V
					-3	
SR	Slew rate	R _L = 10 kΩ, C _L = 100 pF, V _{out} = 0.5 V to 1.3 V		0.33		V/μs

Micropower with high merit factor cmos operational amplifiers

(VCC+) = 3.3 V, (VCC-) = 0 V, Vicm = VCC/2, Tamb = 25 °C, RL connected to VCC/2 (unless otherwise specified)

Symbol	Parameter	Conditions	Min.	Typ.	Max.	Unit
V _{io}	Offset voltage	TSV6291			4	mV
		TSV6291A			0.8	
		T _{min} < T _{op} < T _{max} , TSV6291			6	
		T _{min} < T _{op} < T _{max} , TSV6291A			2	
DV _{io}	Input offset voltage drift			2		μV/°C
I _{io}	Input offset current ⁽¹⁾	T _{min} < T _{op} < T _{max}		1	10	pA
				1	100	
I _{ib}	Input bias current ⁽¹⁾	T _{min} < T _{op} < T _{max}		1	10	
				1	100	
CMR	Common mode rejection ratio, 20 log (ΔV _{ic} /ΔV _{io})	0 V to 3.3 V, V _{out} = 1.65 V	57	79		dB
		T _{min} < T _{op} < T _{max}	53			
A _{vd}	Large signal voltage gain	R _L = 10 kΩ, V _{out} = 0.5 V to 2.8 V	81	98		dB
		T _{min} < T _{op} < T _{max}	76			
V _{OH}	High-level output voltage, V _{OH} = V _{CC} - V _{out}	R _L = 10 kΩ		5	35	mV
		T _{min} < T _{op} < T _{max}			50	
V _{OL}	Low-level output voltage	R _L = 10 kΩ		4	35	
		T _{min} < T _{op} < T _{max}			50	
I _{out}	Isink	V _{out} = 5 V	23	45		mA
		T _{min} < T _{op} < T _{max}	20			
	Isource	V _{out} = 0 V	23	38		
		T _{min} < T _{op} < T _{max}	20			
I _{cc}	Supply current (per operator)	No load, V _{out} = 2.5 V		26	33	μA
		T _{min} < T _{op} < T _{max}			35	
GBP	Gain bandwidth product	R _L = 10 kΩ, C _L = 100 pF		1.2		MHz
Gain	Minimum gain for stability	Phase margin = 60°, R _f = 10 kΩ, R _L = 10 kΩ, C _L = 20 pF		4		V/V
					-3	
SR	Slew rate	R _L = 10 kΩ, C _L = 100 pF, V _{out} = 0.5 V to 2.8 V		0.4		V/μs

Micropower with high merit factor cmos operational amplifiers

(VCC+) = 5 V, (VCC-) = 0 V, Vicm = VCC/2, Tamb = 25 °C, RL connected to VCC/2 (unless otherwise specified)

Symbol	Parameter		Min.	Typ.	Max.	Unit
V _{io}	Offset voltage	TSV6291			4	mV
		TSV6291A			0.8	
		T _{min} < T _{op} < T _{max} , TSV6291			6	
		T _{min} < T _{op} < T _{max} , TSV6291A			2	
DV _{io}	Input offset voltage drift			2		μV/°C
I _{io}	Input offset current ⁽¹⁾			1	10	pA
		T _{min} < T _{op} < T _{max}		1	100	
I _{ib}	Input bias current ⁽¹⁾			1	10	pA
		T _{min} < T _{op} < T _{max}		1	100	
CMR	Common mode rejection ratio, 20 log (ΔV _{ic} /ΔV _{io})	0 V to 5 V, V _{out} = 2.5 V	60	80		dB
		T _{min} < T _{op} < T _{max}	55			
SVR	Supply voltage rejection ratio, 20 log (ΔV _{CC} /ΔV _{io})	V _{CC} = 1.8 to 5 V	75	102		dB
		T _{min} < T _{op} < T _{max}	73			
A _{vd}	Large signal voltage gain	R _L = 10 kΩ, V _{out} = 0.5 V to 4.5 V	85	98		dB
		T _{min} < T _{op} < T _{max}	80			
V _{OH}	High-level output voltage, V _{OH} = V _{CC} - V _{out}	R _L = 10 kΩ		7	35	mV
		T _{min} < T _{op} < T _{max}			50	
V _{OL}	Low-level output voltage	R _L = 10 kΩ		6	35	mV
		T _{min} < T _{op} < T _{max}			50	
I _{out}	I _{sink}	V _{out} = 5 V	40	69		mA
		T _{min} < T _{op} < T _{max}	35			
	I _{source}	V _{out} = 0 V	40	74		
		T _{min} < T _{op} < T _{max}	35			
I _{CC}	Supply current (per operator)	No load, V _{out} = 2.5 V		30	36	μA
		T _{min} < T _{op} < T _{max}			38	
GBP	Gain bandwidth product	R _L = 10 kΩ, C _L = 100 pF		1.3		MHz
Gain	Minimum gain for stability	Phase margin = 60 °, R _f = 10 kΩ, R _L = 10 kΩ, C _L = 20 pF		4		V/V
					-3	
SR	Slew rate	R _L = 10 kΩ, C _L = 100 pF, V _{out} = 0.5 V to 4.5 V		0.5		V/μs
e _n	Equivalent input noise voltage	f = 1 kHz		70		nV/√Hz
THD	Total harmonic distortion	A _v = -10, f _{in} = 1 kHz, R _L = 100 kΩ, V _{icm} = V _{CC} /2, V _{in} = 40 mVpp		0.15		%

Electrical characteristic curves

Figure 2: Supply current vs. supply voltage at $V_{icm} = V_{CC}/2$

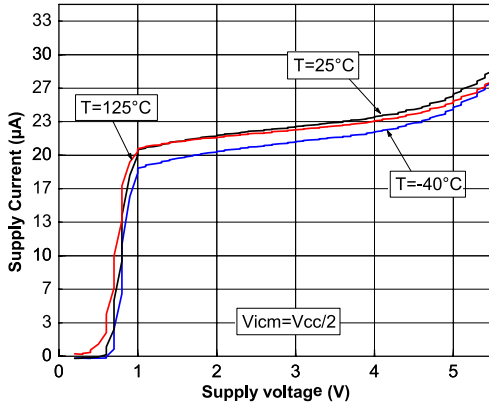

Figure 3: Output current vs. output voltage at $V_{CC} = 1.5 V$

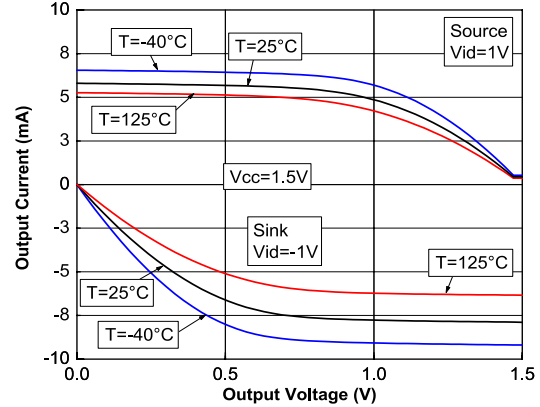

Figure 4: Output current vs. output voltage at $V_{CC} = 5 V$

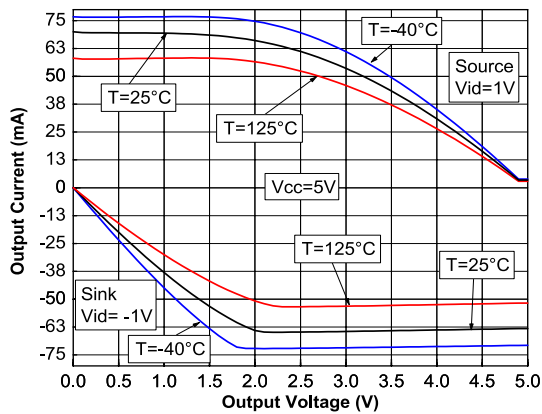

Figure 5: Peaking at closed loop gain = -10 at $V_{CC} = 1.5 V$ and $V_{CC} = 5 V$

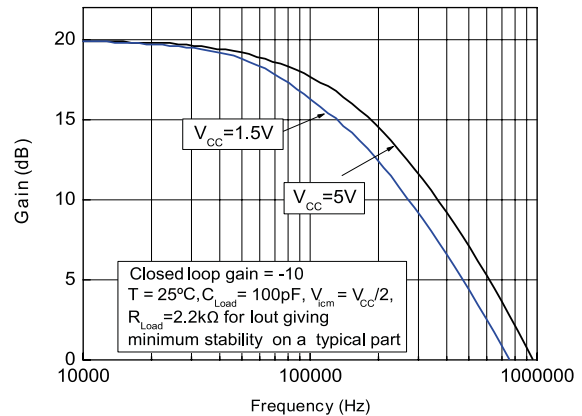

Figure 6: Peaking at closed loop gain = -3, $V_{CC} = 1.5 V$

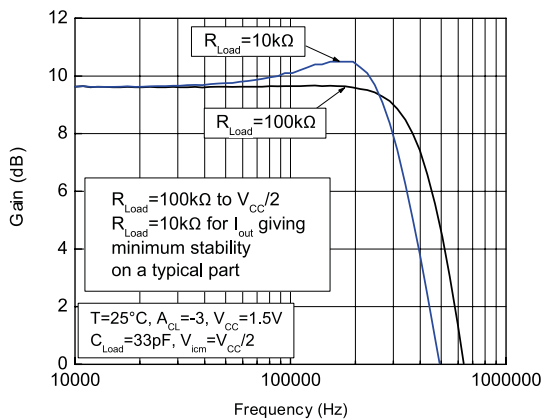

Figure 7: Peaking at closed loop gain = -3, $V_{CC} = 5 V$

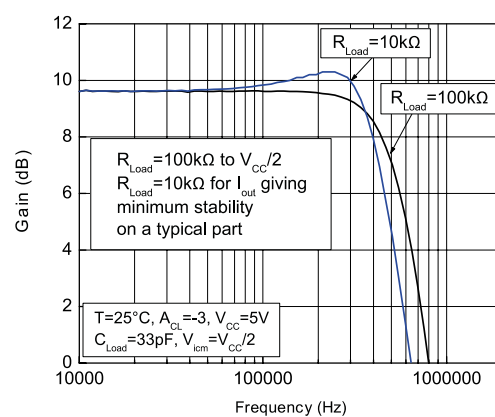

Figure 8: Positive slew rate vs. supply voltage in closed loop

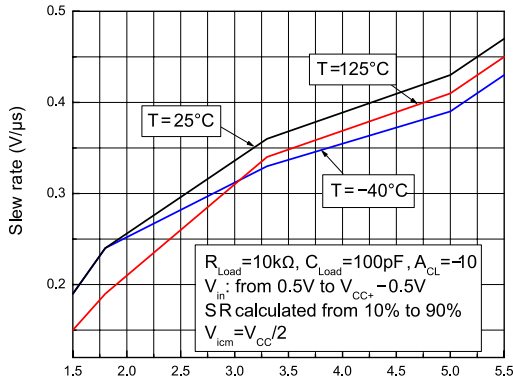

Figure 9: Negative slew rate vs. supply voltage in closed loop

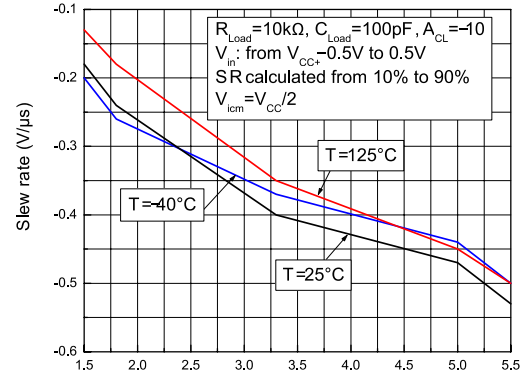

Figure 10: Slew rate vs. supply voltage in open loop

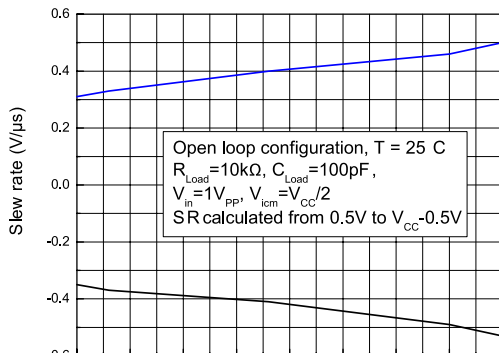

Figure 11: Slew rate timing in open loop

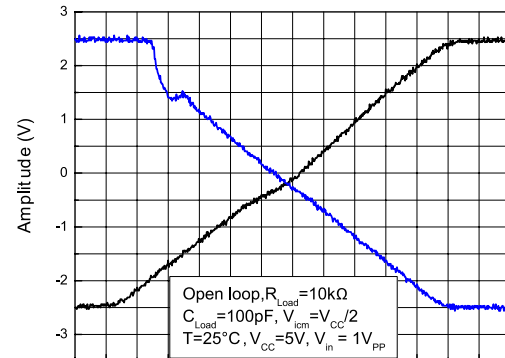

Figure 12: Slew rate timing in closed loop

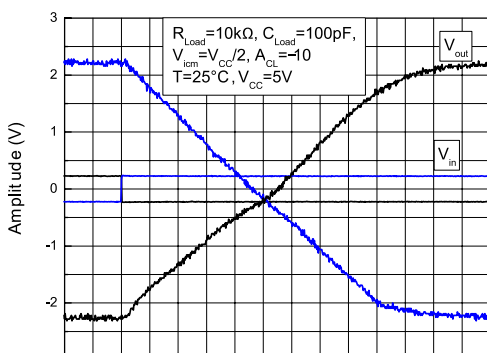

Figure 13: Noise at VCC = 5 V

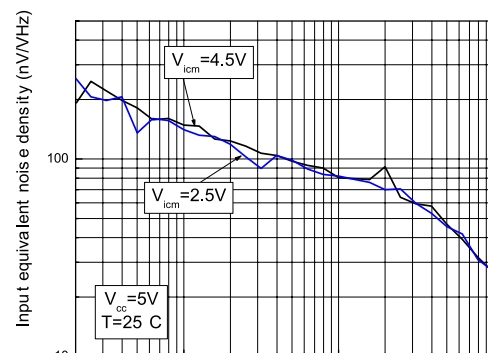

Figure 14: Distortion + noise vs. output voltage at VCC = 1.8 V

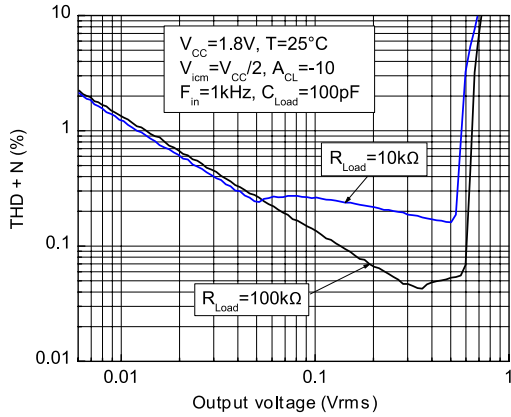

Figure 15: Distortion + noise vs. output voltage at VCC = 5 V

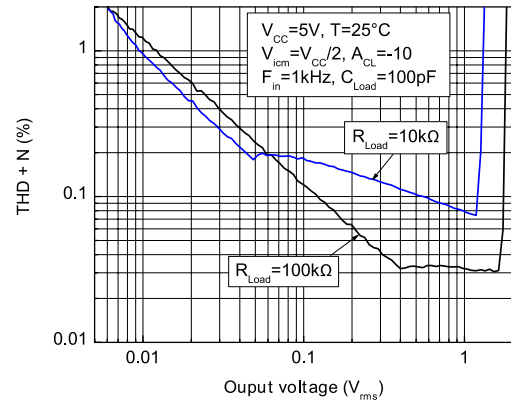

Figure 16: Distortion + noise vs. frequency at VCC = 1.8 V

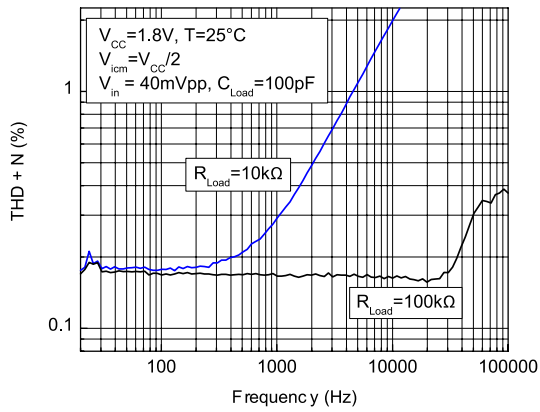

Figure 17: Distortion + noise vs. frequency at VCC = 5 V

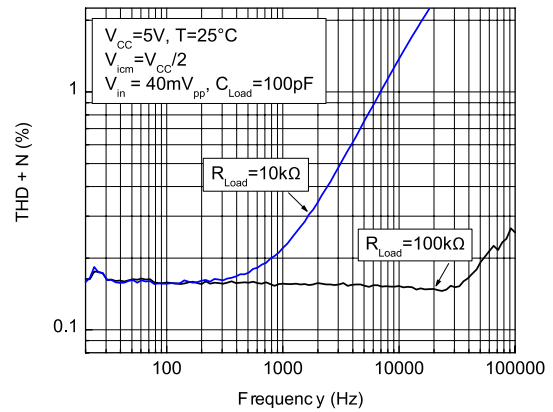

Figure 18: Input offset voltage vs. input common mode at VCC = 1.5 V

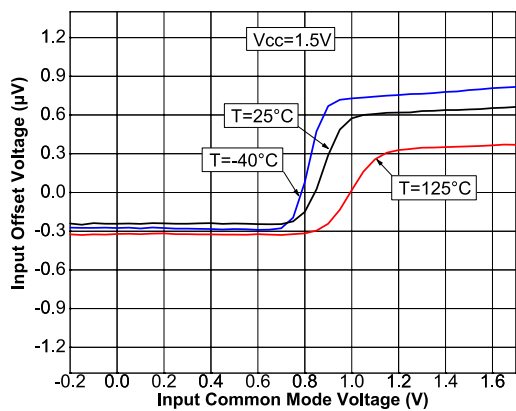

Figure 19: Input offset voltage vs. input common mode at VCC = 5 V

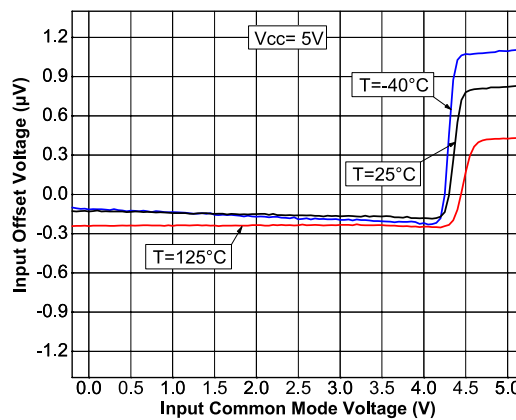

Figure 20: Test configuration for turn-on time (Vout pulled down)

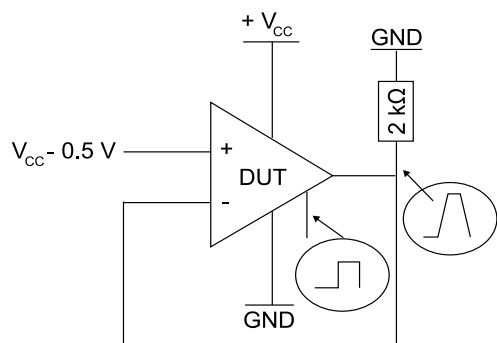

Figure 21: Test configuration for turn-off time (Vout pulled down)

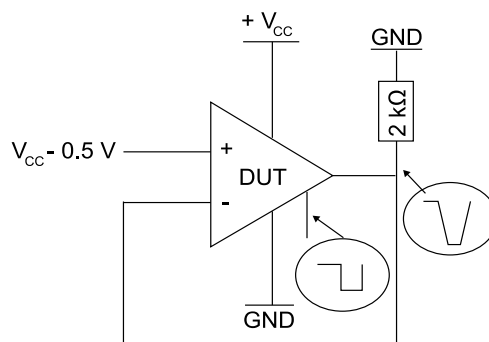

Figure 22: Turn-on time, VCC = 5 V, Vout pulled down, T = 25 °C

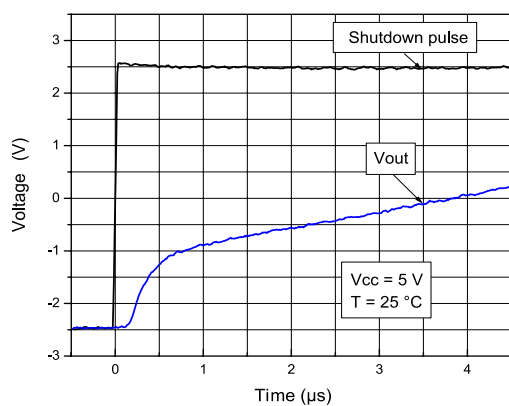
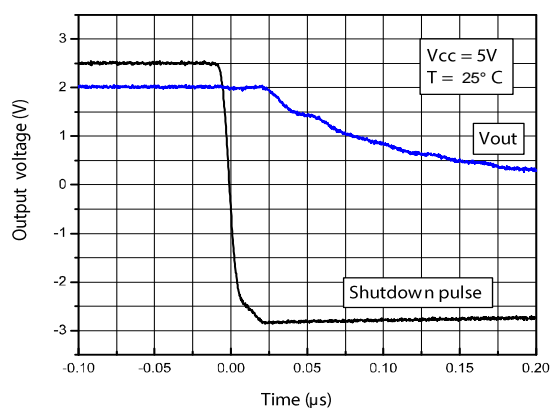
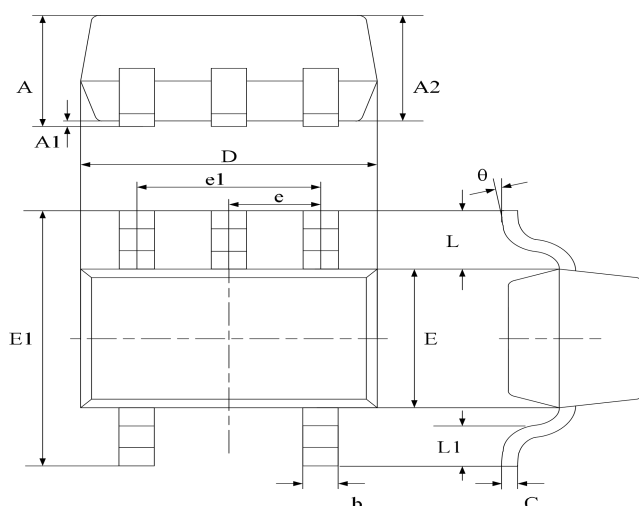

Figure 23: Turn-off time, VCC= 5 V, Vout pulled down, T = 25 °C



Package Information

SC70-5 (SOT353)



Symbol	Dimensions In Millimeters		Dimensions In Inches	
	Min	Max	Min	Max
A	0.800	1.100	0.035	0.043
A1	0.000	0.100	0.000	0.004
A2	0.800	0.900	0.035	0.039
b	0.150	0.350	0.006	0.014
C	0.080	0.150	0.003	0.006
D	1.8500	2.150	0.079	0.087
E	1.100	1.400	0.045	0.053
E1	1.950	2.200	0.085	0.096
e	0.850 typ.		0.026 typ.	
e1	1.200	1.400	0.047	0.055
L	0.42 ref.		0.021 ref.	
L1	0.260	0.460	0.010	0.018
θ	0°	8°	0°	8°

SOT23-5

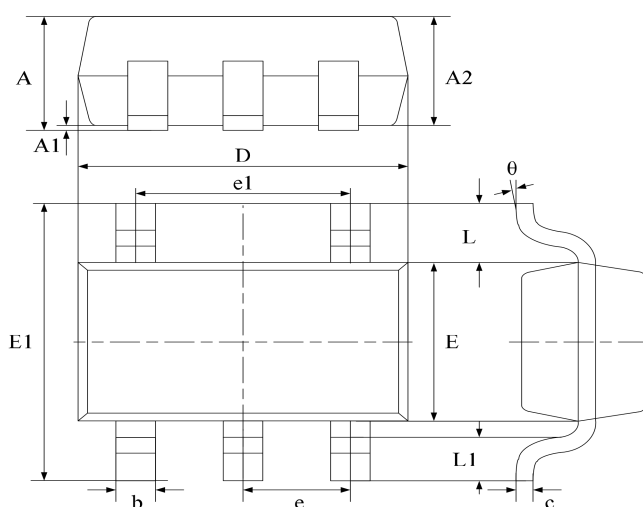

Symbol	Dimensions In Millimeters		Dimensions In Inches	
	Min	Max	Min	Max
A	1.040	1.350	0.042	0.055
A1	0.040	0.150	0.002	0.006
A2	1.000	1.200	0.041	0.049
b	0.380	0.480	0.015	0.020
c	0.110	0.210	0.004	0.009
D	2.720	3.120	0.111	0.127
E	1.400	1.800	0.057	0.073
E1	2.600	3.000	0.106	0.122
e	0.950 typ.		0.037 typ.	
e1	1.900 typ.		0.078 typ.	
L	0.700 ref.		0.028 ref.	
L1	0.300	0.600	0.012	0.024
θ	0°	8°	0°	8°

Ordering information

Order code	Package	Baseqty	Deliverymode	Marking
UMW TSV6291AILT	SOT23-5	3000	Tape and reel	K113 U
UMW TSV6291ILT	SOT23-5	3000	Tape and reel	K107 U
UMW TSV6291AICT	SC70-5	3000	Tape and reel	K15 U

X-ON Electronics

Largest Supplier of Electrical and Electronic Components

Click to view similar products for [Operational Amplifiers - Op Amps](#) category:

Click to view products by [Youtai](#) manufacturer:

Other Similar products are found below :

[430227FB](#) [LT1678IS8](#) [NCV33202DMR2G](#) [NJM324E](#) [M38510/13101BPA](#) [NTE925](#) [AZV358MTR-G1](#) [AP4310AUMTR-AG1](#)
[AZV358MMTR-G1](#) [SCY33178DR2G](#) [NCV20034DR2G](#) [NTE778S](#) [NTE871](#) [NTE937](#) [NJU7057RB1-TE2](#) [SCY6358ADR2G](#)
[NJM2904CRB1-TE1](#) [UPC4570G2-E1-A](#) [UPC4741G2-E1-A](#) [UPC4574GR-9LG-E1-A](#) [NJM8532RB1-TE1](#) [EL2250CS](#) [EL5100IS](#) [EL5104IS](#)
[EL5127CY](#) [EL5127CYZ](#) [EL5133IW](#) [EL5152IS](#) [EL5156IS](#) [EL5162IS](#) [EL5202IY](#) [EL5203IY](#) [EL5204IY](#) [EL5210CS](#) [EL5210CYZ](#)
[EL5211IYE](#) [EL5220CY](#) [EL5223CLZ](#) [EL5223CR](#) [EL5224ILZ](#) [EL5227CLZ](#) [EL5227CRZ](#) [EL5244CS](#) [EL5246CS](#) [EL5246CSZ](#) [EL5250IY](#)
[EL5251IS](#) [EL5257IS](#) [EL5260IY](#) [EL5261IS](#)