

Description

The TSV91x and TSV91xA operational amplifiers (op amps) offer low voltage operation and rail-to-rail input and output, as well as an excellent speed/power consumption ratio, providing an 8 MHz gain-bandwidth product while consuming only 1.1 mA maximum at 5 V. The op amps are unity gain stable and feature an ultra-low input bias current.

The devices are ideal for sensor interfaces, battery-supplied and portable applications, as well as active filtering.

Features

- Rail-to-rail input and output
- Wide bandwidth
- Low power consumption: 820 μ A typ.
- Unity gain stability
- High output current: 35 mA
- Operating from 2.5 V to 5.5 V
- Low input bias current, 1 pA typ.
- Low input offset voltage: 1.5 mV max. (A grade)
- ESD internal protection \geq 5 kV
- Latch-up immunity

Applications

- Battery-powered applications
- Portable devices
- Signal conditioning
- Active filtering
- Medical instrumentation
- Automotive applications

Package pin connections

Figure 1. Pin connections for each package (top view)

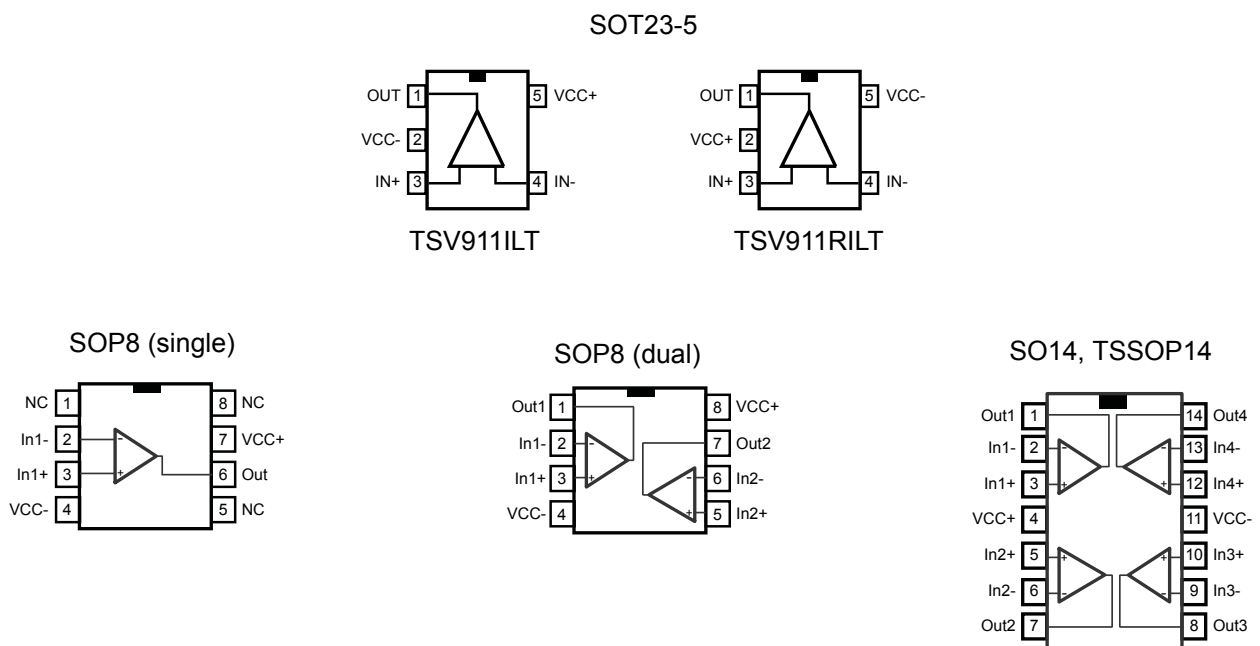

Absolute maximum ratings and operating conditions

Table 1. Absolute maximum ratings (AMR)

Symbol	Parameter	Value	Unit	
V_{CC}	Supply voltage ⁽¹⁾	6	V	
V_{id}	Differential input voltage ⁽²⁾	$\pm V_{CC}$		
V_{in}	Input voltage ⁽³⁾	$(V_{CC-}) - 0.2$ to $(V_{CC+}) + 0.2$		
I_{in}	Input current ⁽⁴⁾	10	mA	
T_{stg}	Storage temperature	-65 to 150	°C	
T_j	Maximum junction temperature	150		
R_{thja}	Thermal resistance junction to ambient ^{(5) (6)}	SOT23-5	250	°C/W
		SOP8	125	
		SOP14	103	
		TSSOP14	100	
R_{thjc}	Thermal resistance junction to case ^{(5) (6)}	SOT23-5	81	
		SOP8	40	
		SOP14	31	
		TSSOP14	32	
ESD	HBM: human body model ⁽⁷⁾		5	kV
	MM: machine model ⁽⁸⁾		400	V
	CDM: charged device model ⁽⁹⁾	SOT23-5, SOP8	1500	
		TSSOP14	750	
		SOP14	500	
	Latch-up immunity	200	mA	

1. All voltage values, except the differential voltage, are with respect to network ground terminal.
2. Differential voltages are the non-inverting input terminal with respect to the inverting input terminal
3. $V_{CC} - V_{IN}$ must not exceed 6 V
4. Input current must be limited by a resistor in series with the inputs
5. Short-circuits can cause excessive heating and destructive dissipation.
6. R_{th} are typical values
7. Human body model: 100 pF discharged through a 1.5 kΩ resistor between two pins of the device, done for all couples of pin combinations with other pins floating.
8. Machine model: 200 pF charged to the specified voltage, then discharged directly between two pins of the device with no external series resistor (internal resistor < 5 Ω), done for all couples of pin combinations with other pins floating
9. Charged device model: all pins plus packages are charged together to the specified voltage and then discharged directly to the ground.

Table 2. Operating conditions

Symbol	Parameter	Value	Unit
V _{CC}	Supply voltage	-40 °C < T _{op} < 125 °C	2.5 to 5.5
		0 °C < T _{op} < 125 °C	2.3 to 5.5
V _{icm}	Common mode input voltage range	(V _{CC-}) - 0.1 to (V _{CC+}) + 0.1	V
T _{op}	Operating free air temperature range	-40 to 125	°C

Electrical characteristics

Table 3. Electrical characteristics at $V_{CC+} = 2.5\text{ V}$, $V_{CC-} = 0\text{ V}$, $V_{icm} = V_{CC}/2$, with R_L connected to $V_{CC}/2$, $T = 25\text{ }^\circ\text{C}$ (unless otherwise specified)

Symbol	Parameter	Conditions	Min.	Typ.	Max.	Unit
DC performance						
V_{io}	Offset voltage, TSV91x	$T_{op} = 25\text{ }^\circ\text{C}$		0.1	4.5	mV
		$T_{min} < T_{op} < T_{max}$			7.5	
	Offset voltage, TSV91xA	$T_{op} = 25\text{ }^\circ\text{C}$			1.5	
		$T_{min} < T_{op} < T_{max}$			3	
$\Delta V_{io}/\Delta T$	Input offset voltage drift			5		$\mu\text{V}/^\circ\text{C}$
I_{io}	Input offset current ⁽¹⁾	$T_{op} = 25\text{ }^\circ\text{C}$		1	10	pA
		$T_{min} < T_{op} < T_{max}$			100	
I_{ib}	Input bias current ⁽¹⁾	$T_{op} = 25\text{ }^\circ\text{C}$		1	10	
		$T_{min} < T_{op} < T_{max}$			100	
CMR	Common mode rejection ratio, 20 log ($\Delta V_{io}/\Delta V_{io}$)	$0\text{ V to } 2.5\text{ V}$, $V_{out} = 1.25\text{ V}$, $T_{op} = 25\text{ }^\circ\text{C}$	58	75		dB
		$T_{min} < T_{op} < T_{max}$	53			
A_{vd}	Large signal voltage gain	$R_L = 10\text{ k}\Omega$, $V_{out} = 0.5\text{ V to } 2\text{ V}$, $T_{op} = 25\text{ }^\circ\text{C}$	80	89		
		$T_{min} < T_{op} < T_{max}$	75			
$V_{CC} - V_{OH}$	High-level output voltage	$R_L = 10\text{ k}\Omega$		15	40	mV
		$T_{min} < T_{op} < T_{max}$			40	
		$R_L = 600\text{ }\Omega$		45	150	
		$T_{min} < T_{op} < T_{max}$			150	
V_{OL}	Low-level output voltage	$R_L = 10\text{ k}\Omega$		15	40	
		$T_{min} < T_{op} < T_{max}$			40	
		$R_L = 600\text{ }\Omega$		45	150	
		$T_{min} < T_{op} < T_{max}$			150	
I_{out}	I_{sink}	$V_o = 2.5\text{ V}$, $T_{op} = 25\text{ }^\circ\text{C}$	18	32		mA
		$T_{min} < T_{op} < T_{max}$	16			
	I_{source}	$V_o = 0\text{ V}$, $T_{op} = 25\text{ }^\circ\text{C}$	18	35		
		$T_{min} < T_{op} < T_{max}$	16			
I_{CC}	Supply current (per channel)	No load, $V_{out} = V_{CC}/2$		0.78	1.1	
		$T_{min} < T_{op} < T_{max}$			1.1	
AC performance						
GBP	Gain bandwidth product	$R_L = 2\text{ k}\Omega$, $C_L = 100\text{ pF}$, $f = 100\text{ kHz}$, $T_{op} = 25\text{ }^\circ\text{C}$		8		MHz
F_u	Unity gain frequency	$R_L = 2\text{ k}\Omega$, $C_L = 100\text{ pF}$, $T_{op} = 25\text{ }^\circ\text{C}$		7.2		
ϕ_m	Phase margin	$R_L = 2\text{ k}\Omega$, $C_L = 100\text{ pF}$, $T_{op} = 25\text{ }^\circ\text{C}$		45		Degrees

Single, dual, and quad rail-to-rail input/output 8 MHz operational amplifiers

Symbol	Parameter	Conditions	Min.	Typ.	Max.	Unit
G_m	Gain margin	$R_L = 2\text{ k}\Omega$, $C_L = 100\text{ pF}$, $T_{op} = 25\text{ }^\circ\text{C}$		8		dB
SR	Slew rate	$R_L = 2\text{ k}\Omega$, $C_L = 100\text{ pF}$, $A_v = 1$, $T_{op} = 25\text{ }^\circ\text{C}$		4.5		V/ μs
e_n	Equivalent input noise voltage	$f = 10\text{ kHz}$, $T_{op} = 25\text{ }^\circ\text{C}$		21		nV/ $\sqrt{\text{Hz}}$
THD+ e_n	Total harmonic distortion	$G = 1$, $f = 1\text{ kHz}$, $R_L = 2\text{ k}\Omega$, $\text{BW} = 22\text{ kHz}$, $T_{op} = 25\text{ }^\circ\text{C}$, $V_{icm} = (V_{CC} + 1)/2$, $V_{out} = 1.1\text{ V}_{pp}$		0.001		%

Single, dual, and quad rail-to-rail input/output 8 MHz operational amplifiers

Table 4. Electrical characteristics at $V_{CC+} = 3.3\text{ V}$, $V_{CC-} = 0\text{ V}$, $V_{icm} = V_{CC}/2$, with R_L connected to $V_{CC}/2$, $T = 25\text{ }^\circ\text{C}$ (unless otherwise specified)

Symbol	Parameter	Conditions	Min.	Typ.	Max.	Unit
DC performance						
V_{io}	Offset voltage, TSV91x	$T_{op} = 25\text{ }^\circ\text{C}$		0.1	4.5	mV
		$T_{min} < T_{op} < T_{max}$			7.5	
	Offset voltage, TSV91xA	$T_{op} = 25\text{ }^\circ\text{C}$			1.5	
		$T_{min} < T_{op} < T_{max}$			3	
$\Delta V_{io}/\Delta T$	Input offset voltage drift			5		$\mu\text{V}/^\circ\text{C}$
I_{io}	Input offset current ⁽¹⁾	$T_{op} = 25\text{ }^\circ\text{C}$		1	10	pA
		$T_{min} < T_{op} < T_{max}$			100	
I_{ib}	Input bias current ⁽¹⁾	$T_{op} = 25\text{ }^\circ\text{C}$		1	10	
		$T_{min} < T_{op} < T_{max}$			100	
CMR	Common mode rejection ratio, $20 \log (\Delta V_{ic}/\Delta V_{io})$	$0\text{ V to } 3.3\text{ V}$, $V_{out} = 1.65\text{ V}$, $T_{op} = 25\text{ }^\circ\text{C}$	60	78		dB
		$T_{min} < T_{op} < T_{max}$	55			
		A_{vd}	Large signal voltage gain	$R_L = 10\text{ k}\Omega$, $V_{out} = 0.5\text{ V to } 2.8\text{ V}$, $T_{op} = 25\text{ }^\circ\text{C}$	80	
$T_{min} < T_{op} < T_{max}$	75					
$V_{CC} - V_{OH}$	High-level output voltage	$R_L = 10\text{ k}\Omega$		15	40	mV
		$T_{min} < T_{op} < T_{max}$			40	
		$R_L = 600\text{ }\Omega$		45	150	
		$T_{min} < T_{op} < T_{max}$			150	
V_{OL}	Low-level output voltage	$R_L = 10\text{ k}\Omega$		15	40	
		$T_{min} < T_{op} < T_{max}$			40	
		$R_L = 600\text{ }\Omega$		45	150	
		$T_{min} < T_{op} < T_{max}$			150	
I_{out}	I_{sink}	$V_o = 3.3\text{ V}$, $T_{op} = 25\text{ }^\circ\text{C}$	18	32		mA
		$T_{min} < T_{op} < T_{max}$	16			
	I_{source}	$V_o = 0\text{ V}$, $T_{op} = 25\text{ }^\circ\text{C}$	18	35		
		$T_{min} < T_{op} < T_{max}$	16			
I_{CC}	Supply current (per channel)	No load, $V_{out} = V_{CC}/2$		0.8	1.1	
		$T_{min} < T_{op} < T_{max}$			1.1	
AC performance						
GBP	Gain bandwidth product	$R_L = 2\text{ k}\Omega$, $C_L = 100\text{ pF}$, $f = 100\text{ kHz}$, $T_{op} = 25\text{ }^\circ\text{C}$		8		MHz
F_u	Unity gain frequency	$R_L = 2\text{ k}\Omega$, $C_L = 100\text{ pF}$, $T_{op} = 25\text{ }^\circ\text{C}$		7.2		
ϕ_m	Phase margin	$R_L = 2\text{ k}\Omega$, $C_L = 100\text{ pF}$, $T_{op} = 25\text{ }^\circ\text{C}$		45		Degrees
G_m	Gain margin	$R_L = 2\text{ k}\Omega$, $C_L = 100\text{ pF}$, $T_{op} = 25\text{ }^\circ\text{C}$		8		dB

Single, dual, and quad rail-to-rail input/output 8 MHz operational amplifiers

Symbol	Parameter	Conditions	Min.	Typ.	Max.	Unit
SR	Slew rate	$R_L = 2\text{ k}\Omega$, $C_L = 100\text{ pF}$, $A_v = 1$, $T_{op} = 25\text{ }^\circ\text{C}$		4.5		V/ μs
e_n	Equivalent input noise voltage	$f = 10\text{ kHz}$, $T_{op} = 25\text{ }^\circ\text{C}$		21		nV/ $\sqrt{\text{Hz}}$
THD+ e_n	Total harmonic distortion	$G = 1$, $f = 1\text{ kHz}$, $R_L = 2\text{ k}\Omega$, $BW = 22\text{ kHz}$, $T_{op} = 25\text{ }^\circ\text{C}$, $V_{icm} = (V_{CC} + 1)/2$, $V_{out} = 1.9\text{ V}_{pp}$		0.0007		%

Single, dual, and quad rail-to-rail input/output 8 MHz operational amplifiers

Table 5. Electrical characteristics at $V_{CC+} = 5\text{ V}$, $V_{CC-} = 0\text{ V}$, $V_{icm} = V_{CC}/2$, with R_L connected to $V_{CC}/2$, $T = 25\text{ }^\circ\text{C}$ (unless otherwise specified)

Symbol	Parameter	Conditions	Min.	Typ.	Max.	Unit
DC performance						
V_{io}	Offset voltage, TSV91x	$T_{op} = 25\text{ }^\circ\text{C}$		0.1	4.5	mV
		$T_{min} < T_{op} < T_{max}$			7.5	
	Offset voltage, TSV91xA	$T_{op} = 25\text{ }^\circ\text{C}$			1.5	
		$T_{min} < T_{op} < T_{max}$			3	
$\Delta V_{io}/\Delta T$	Input offset voltage drift			5		$\mu\text{V}/^\circ\text{C}$
I_{io}	Input offset current ⁽¹⁾	$T_{op} = 25\text{ }^\circ\text{C}$		1	10	pA
		$T_{min} < T_{op} < T_{max}$			100	
I_{ib}	Input bias current ⁽¹⁾	$T_{op} = 25\text{ }^\circ\text{C}$		1	10	
		$T_{min} < T_{op} < T_{max}$			100	
CMR	Common mode rejection ratio, $20 \log (\Delta V_{ic}/\Delta V_{io})$	$0\text{ V to } 5\text{ V}$, $V_{out} = 2.5\text{ V}$, $T_{op} = 25\text{ }^\circ\text{C}$	62	82		dB
		$T_{min} < T_{op} < T_{max}$	58			
SVR	Supply voltage rejection ratio, $20 \log (\Delta V_{CC}/\Delta V_{io})$	$V_{CC} = 2.5\text{ to } 5\text{ V}$	70	86		
A_{vd}	Large signal voltage gain	$R_L = 10\text{ k}\Omega$, $V_{out} = 0.5\text{ V to } 4.5\text{ V}$, $T_{op} = 25\text{ }^\circ\text{C}$	80	91		
		$T_{min} < T_{op} < T_{max}$	75			
$V_{CC} - V_{OH}$	High-level output voltage	$R_L = 10\text{ k}\Omega$		15	40	mV
		$T_{min} < T_{op} < T_{max}$			40	
		$R_L = 600\ \Omega$		45	150	
		$T_{min} < T_{op} < T_{max}$			150	
V_{OL}	Low-level output voltage	$R_L = 10\text{ k}\Omega$		15	40	mV
		$T_{min} < T_{op} < T_{max}$			40	
		$R_L = 600\ \Omega$		45	150	
		$T_{min} < T_{op} < T_{max}$			150	
I_{out}	I_{sink}	$V_o = 5\text{ V}$, $T_{op} = 25\text{ }^\circ\text{C}$	18	32		mA
		$T_{min} < T_{op} < T_{max}$	16			
	I_{source}	$V_o = 0\text{ V}$, $T_{op} = 25\text{ }^\circ\text{C}$	18	35		
		$T_{min} < T_{op} < T_{max}$	16			
I_{CC}	Supply current (per channel)	No load, $V_{out} = 2.5\text{ V}$		0.78	1.1	
		$T_{min} < T_{op} < T_{max}$			1.1	
AC performance						
GBP	Gain bandwidth product	$R_L = 2\text{ k}\Omega$, $C_L = 100\text{ pF}$, $f = 100\text{ kHz}$, $T_{op} = 25\text{ }^\circ\text{C}$		8		MHz
F_u	Unity gain frequency	$R_L = 2\text{ k}\Omega$, $C_L = 100\text{ pF}$, $T_{op} = 25\text{ }^\circ\text{C}$		7.5		
ϕ_m	Phase margin	$R_L = 2\text{ k}\Omega$, $C_L = 100\text{ pF}$, $T_{op} = 25\text{ }^\circ\text{C}$		45		Degrees
G_m	Gain margin	$R_L = 2\text{ k}\Omega$, $C_L = 100\text{ pF}$, $T_{op} = 25\text{ }^\circ\text{C}$		8		dB

Single, dual, and quad rail-to-rail input/output 8 MHz operational amplifiers

Symbol	Parameter	Conditions	Min.	Typ.	Max.	Unit
SR	Slew rate	$R_L = 2\text{ k}\Omega$, $C_L = 100\text{ pF}$, $A_v = 1$, $T_{op} = 25\text{ }^\circ\text{C}$		4.5		V/ μs
e_n	Equivalent input noise voltage	$f = 1\text{ kHz}$, $T_{op} = 25\text{ }^\circ\text{C}$		27		nV/ $\sqrt{\text{Hz}}$
		$f = 10\text{ kHz}$, $T_{op} = 25\text{ }^\circ\text{C}$		21		
THD+ e_n	Total harmonic distortion	$G = 1$, $f = 1\text{ kHz}$, $R_L = 2\text{ k}\Omega$, $\text{BW} = 22\text{ kHz}$, $T_{op} = 25\text{ }^\circ\text{C}$, $V_{icm} = (V_{CC} + 1)/2$, $V_{out} = 3.6\text{ V}_{pp}$		0.0004		%

Electrical characteristic curves

Figure 2. Input offset voltage distribution at T = 25 °C

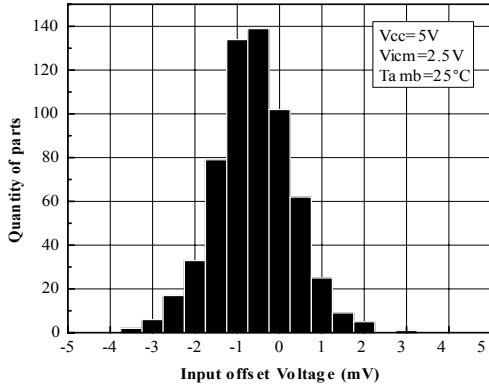

Figure 3. Input offset voltage distribution at T = 125 °C

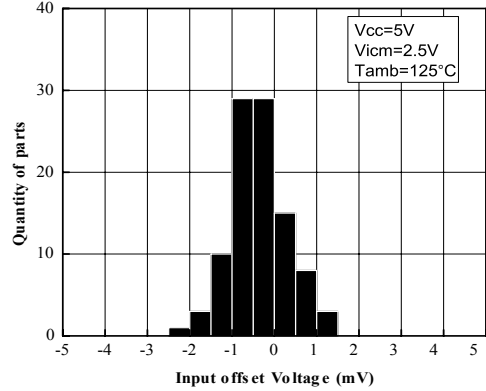

Figure 4. Supply current vs. input common-mode voltage at V_{CC} = 2.5 V

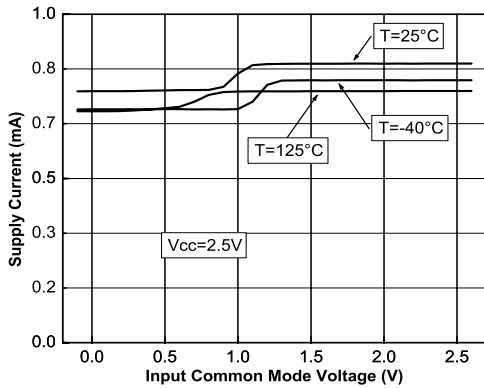

Figure 5. Supply current vs. input common-mode voltage at V_{CC} = 5 V

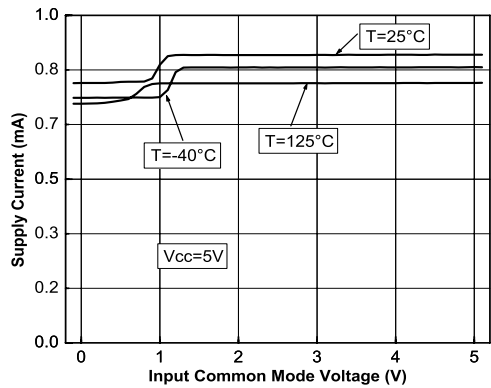

Figure 6. Output current vs. output voltage at V_{CC} = 2.5 V

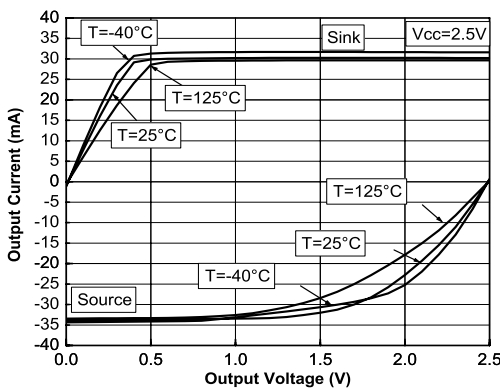
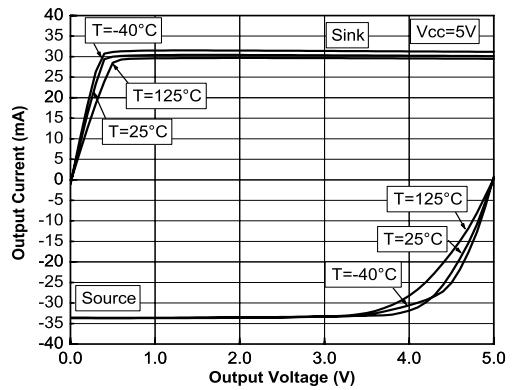

Figure 7. Output current vs. output voltage at V_{CC} = 5 V



Single, dual, and quad rail-to-rail input/output 8 MHz operational amplifiers

Figure 8. Voltage gain and phase vs. frequency at $V_{CC} = 2.5\text{ V}$ and $V_{icm} = 0.5\text{ V}$

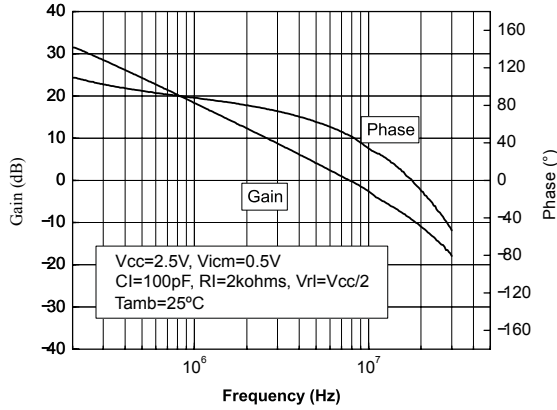

Figure 9. Voltage gain and phase vs. frequency at $V_{CC} = 5.5\text{ V}$ and $V_{icm} = 0.5\text{ V}$

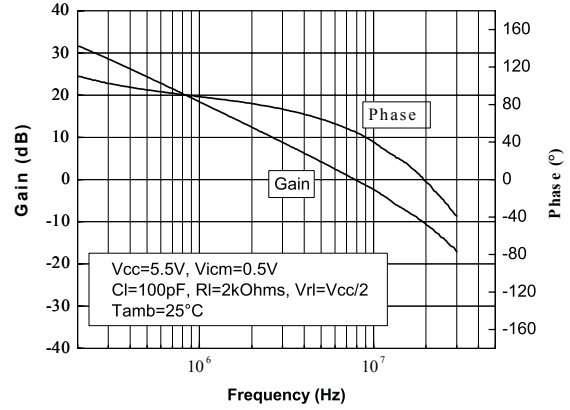

Figure 10. Phase margin vs. capacitive load

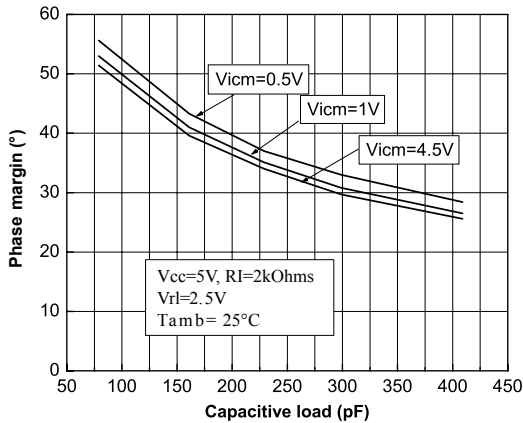

Figure 11. Phase margin vs. output current

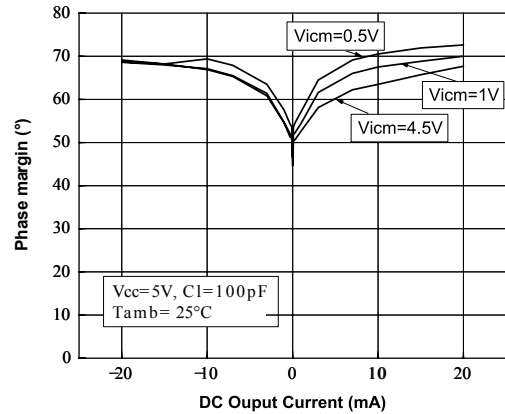

Figure 12. Positive slew rate

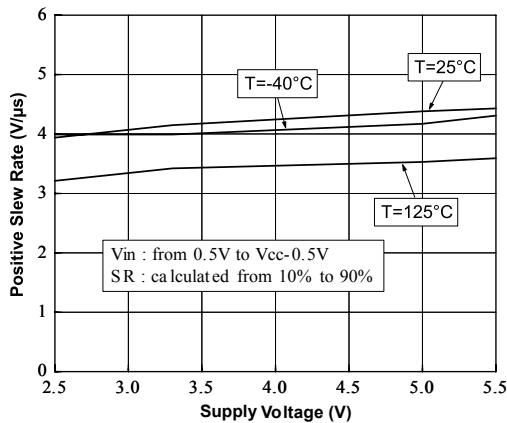

Figure 13. Negative slew rate

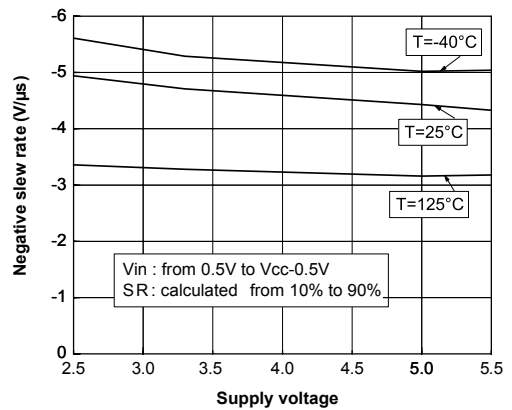

Figure 14. Distortion + noise vs. frequency

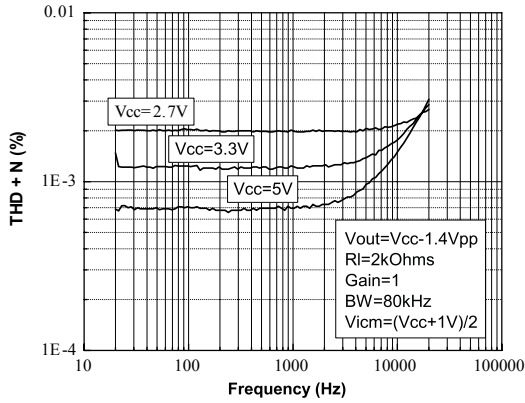

Figure 15. Distortion + noise vs. output voltage

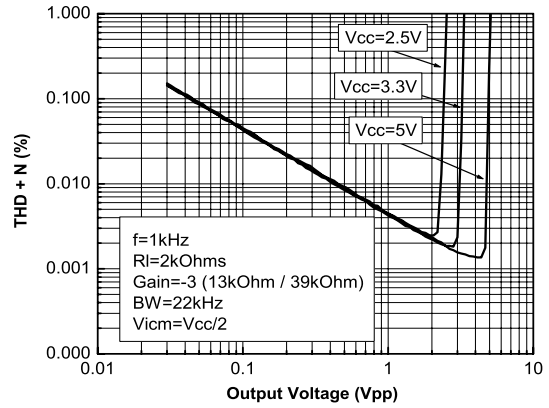

Figure 16. Noise vs. frequency

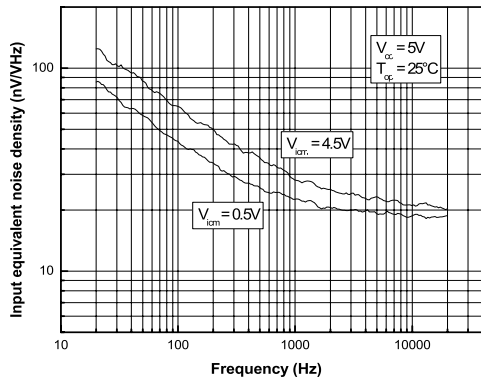

Figure 17. Phase margin vs. capacitive load and serial resistor

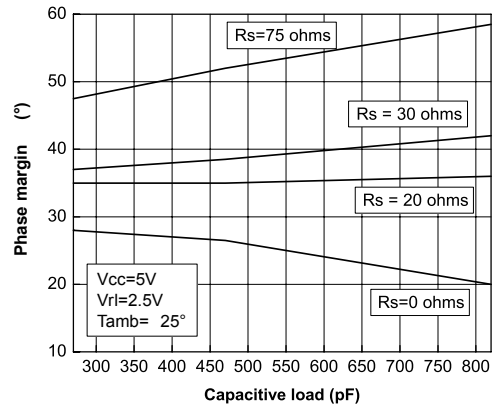
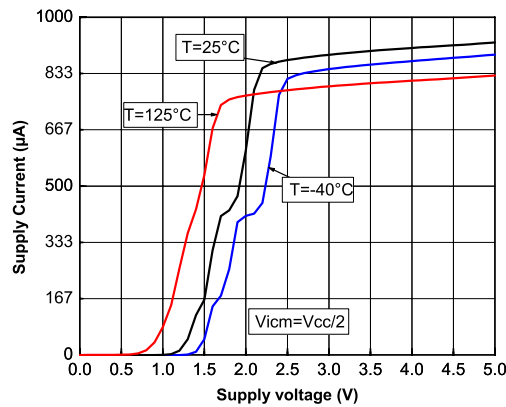
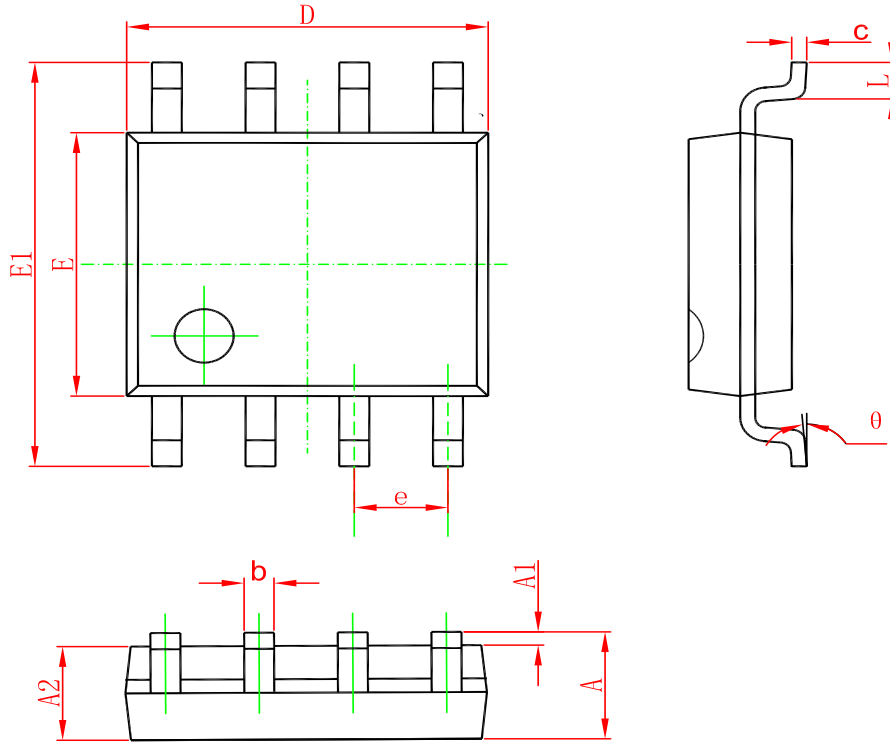

Figure 18. Supply current vs. supply voltage



Package Dimension

SOP-8



Symbol	Dimensions In Millimeters		Dimensions In Inches	
	Min	Max	Min	Max
A	1.350	1.750	0.053	0.069
A1	0.100	0.250	0.004	0.010
A2	1.350	1.550	0.053	0.061
b	0.330	0.510	0.013	0.020
c	0.170	0.250	0.006	0.010
D	4.700	5.100	0.185	0.200
E	3.800	4.000	0.150	0.157
E1	5.800	6.200	0.228	0.244
e	1.270(BSC)		0.050(BSC)	
L	0.400	1.270	0.016	0.050
θ	0°	8°	0°	8°

SOP-14

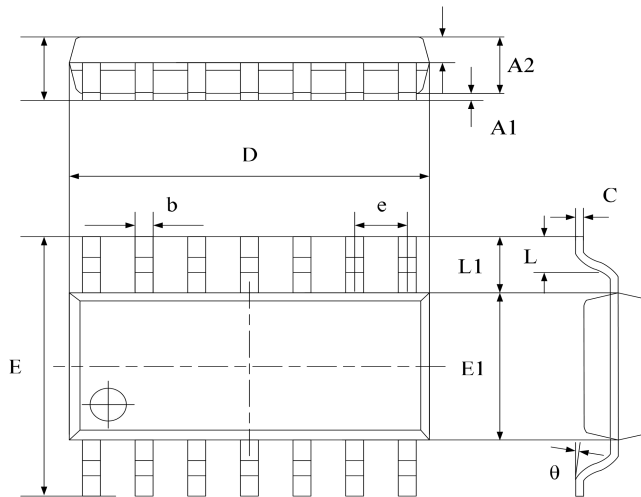

Symbol	Dimensions In Millimeters		Dimensions In Inches	
	Min	Max	Min	Max
A	1.450	1.850	0.059	0.076
A1	0.100	0.300	0.004	0.012
A2	1.350	1.550	0.055	0.063
A3	0.550	0.750	0.022	0.031
b	0.406typ.		0.017typ.	
C	0.203typ.		0.008typ.	
D	8.630	8.830	0.352	0.360
E	5.840	6.240	0.238	0.255
E1	3.850	4.050	0.157	0.165
e	1.270 typ.		0.050 typ.	
L1	1.040 ref.		0.041 ref.	
L	0.350	0.750	0.014	0.031
θ	2°	8°	2°	8°

TSSOP-14

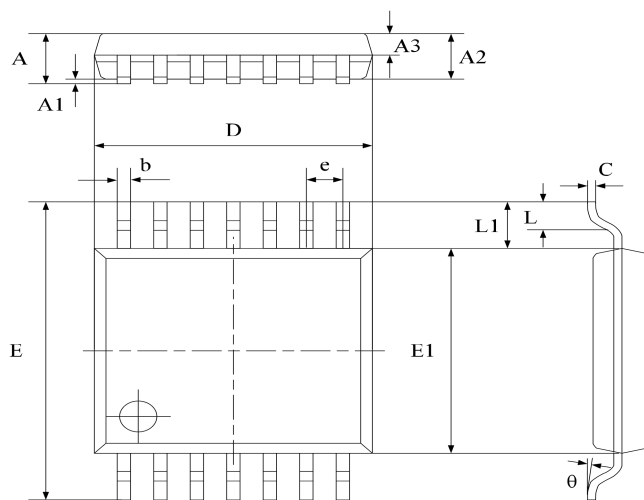

Symbol	Dimensions In Millimeters		Dimensions In Inches	
	Min	Max	Min	Max
A	-	1.200	-	0.0472
A1	0.050	0.150	0.002	0.006
A2	0.900	1.050	0.037	0.043
A3	0.390	0.490	0.016	0.020
b	0.200	0.290	0.008	0.012
C	0.130	0.180	0.005	0.007
D	4.860	5.060	0.198	0.207
E	6.200	6.600	0.253	0.269
E1	4.300	4.500	0.176	0.184
e	0.650 typ.		0.0256 typ.	
L1	1.000 ref.		0.0393 ref.	
L	0.450	0.750	0.018	0.031
θ	0°	8°	0°	8°

SOT23-5

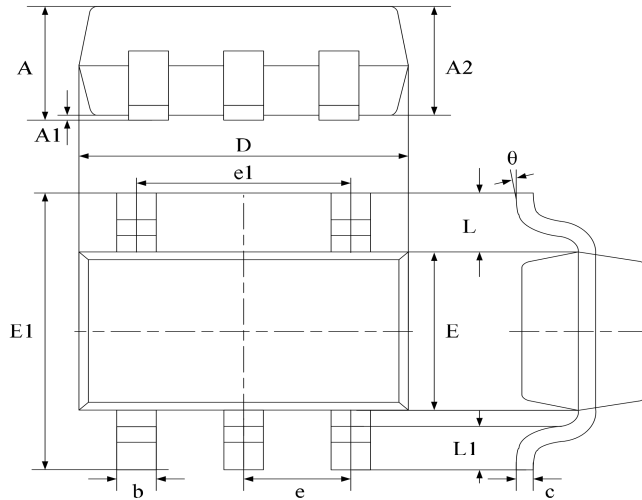

Symbol	Dimensions In Millimeters		Dimensions In Inches	
	Min	Max	Min	Max
A	1.040	1.350	0.042	0.055
A1	0.040	0.150	0.002	0.006
A2	1.000	1.200	0.041	0.049
b	0.380	0.480	0.015	0.020
c	0.110	0.210	0.004	0.009
D	2.720	3.120	0.111	0.127
E	1.400	1.800	0.057	0.073
E1	2.600	3.000	0.106	0.122
e	0.950 typ.		0.037 typ.	
e1	1.900 typ.		0.078 typ.	
L	0.700 ref.		0.028 ref.	
L1	0.300	0.600	0.012	0.024
θ	0°	8°	0°	8°

Ordering information

Order code	Package	Baseqty	Deliverymode	Marking
UMW TSV911ILT	SOT23-5	3000	Tape and reel	K127 U
UMW TSV912IDT	SOP-8	2500	Tape and reel	V912I
UMW TSV911IYDT	SOP-8	2500	Tape and reel	TSV911
UMW TSV911AILT	SOT23-5	3000	Tape and reel	K128 U
UMW TSV911AIYDT	SOP-8	2500	Tape and reel	TSV911AI
UMW TSV914IDT	SOP-14	2500	Tape and reel	V914I
UMW TSV914IPT	TSSOP-14	4000	Tape and reel	V914I

X-ON Electronics

Largest Supplier of Electrical and Electronic Components

Click to view similar products for [Operational Amplifiers - Op Amps](#) category:

Click to view products by [Youtai](#) manufacturer:

Other Similar products are found below :

[430227FB](#) [LT1678IS8](#) [NCV33202DMR2G](#) [NJM324E](#) [M38510/13101BPA](#) [NTE925](#) [AZV358MTR-G1](#) [AP4310AUMTR-AG1](#)
[AZV358MMTR-G1](#) [SCY33178DR2G](#) [NCV20034DR2G](#) [NTE778S](#) [NTE871](#) [NTE937](#) [NJU7057RB1-TE2](#) [SCY6358ADR2G](#)
[NJM2904CRB1-TE1](#) [UPC4570G2-E1-A](#) [UPC4741G2-E1-A](#) [UPC4574GR-9LG-E1-A](#) [NJM8532RB1-TE1](#) [EL2250CS](#) [EL5100IS](#) [EL5104IS](#)
[EL5127CY](#) [EL5127CYZ](#) [EL5133IW](#) [EL5152IS](#) [EL5156IS](#) [EL5162IS](#) [EL5202IY](#) [EL5203IY](#) [EL5204IY](#) [EL5210CS](#) [EL5210CYZ](#)
[EL5211IYE](#) [EL5220CY](#) [EL5223CLZ](#) [EL5223CR](#) [EL5224ILZ](#) [EL5227CLZ](#) [EL5227CRZ](#) [EL5244CS](#) [EL5246CS](#) [EL5246CSZ](#) [EL5250IY](#)
[EL5251IS](#) [EL5257IS](#) [EL5260IY](#) [EL5261IS](#)