

TIP127

达林顿三极管(PNP) PNP EPITAXIAL DARLINGTON TRANSISTOR

特性 FEATURES

与TIP122互补
Complementary to TIP122
应用于中功率线性开关
Medium Power Linear Switching Applications

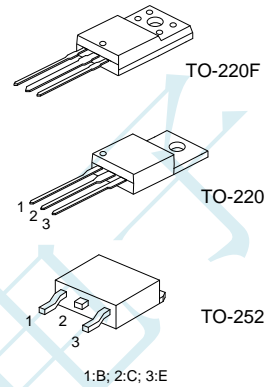

产品订购信息

产品名称 Ordering Number	封装形式 Package	打印名称 Print Number	环保等级 Free	包装 Packing
TIP127-TA3-L-T	TO-220	TIP127	RoHS	料管
TIP127-TNB-L-R	TO-252	TIP127	RoHS	编带
TIP127-TF3-L-T	TO-220F	TIP127	RoHS	料管

TIP127- TA3 - L - R

包装类型: 料管(Tube)T, 卷盘编带(Tape Reel)R,
防静电袋(Bulk)K, T092编带(Tape Box)B
绿色包装: 如无卤无铅G, 无铅L
封装外形: TA3:TO-220; TNB:TO-252;
TF3:TO-220F
产品型号



杭州友旺电子有限公司
YOUWANG ELECTRONICS CO.,LTD

2020.03.31 V1.3

TIP127

绝对最大额定值 MAXIMUM RATINGS (Ta=25°C unless otherwise noted)

项目 Parameter	符号 Symbol	数值 Rating	单位 Unit
集电极、基极击穿电压 Collector-Base Voltage	V _{CBO}	100	V
集电极、发射极击穿电压 Collector-Emitter Voltage	V _{CEO}	100	V
发射极、基极击穿电压 Emitter-Base Voltage	V _{EBO}	5	V
集电极额定电流 Collector Current -Continuous	I _C	5	A
集电极耗散功率 Collector Power Dissipation	P _C	2	W
结到外壳的热阻 (TO-220) Thermal Resistance From Junction To Ambient	R _{θ JA}	62.5	°C/W
结到管壳的热阻 (TO-220) Thermal Resistance Junction to Case	R _{θ JA}	1.92	°C/W
最高结温 Junction Temperature	T _J	150	°C
贮存温度 Storage Temperature Range	T _{stg}	-55to+150	°C

电特性 ELECTRICAL CHARACTERISTICS (Ta=25°C unless otherwise specified)

项目 Parameter	符号 Symbol	测试条件 Test conditions	最小值 Min	最大值 Max.	单位 Unit
集电极、基极击穿电压 Collector-base breakdown voltage	V _{(BR)CBO}	I _C =1mA, I _E =0	100		V
集电极、发射极击穿电压 Collector-emitter breakdown voltage	V _{(BR)CEO}	I _C =30mA, I _B =0	100		V
集电极漏电流 Collector cut-off current	I _{CBO}	V _{CB} =100V, I _E =0		0.2	mA
集电极、发射极漏电流 Collector cut-off current	I _{CEO}	V _{CE} =50V, I _E =0		0.5	mA
发射极漏电流 Emitter cut-off current	I _{EBO}	V _{EB} =5V, I _C =0		2	mA
直流电流增益 DC current gain	hFE(1)	V _{CE} =3V, I _C =0.5A	1000		
	hFE(2)	V _{CE} =3V, I _C =3A	1000		
集电极、发射极饱和和压降 Collector-emitter saturation voltage	V _{CE(sat)}	I _C =3A, I _B =12mA I _C =5A, I _B =20mA		2 4	V
基极、发射极开启电压 Base-emitter voltage	V _{BE}	V _{CE} =3V, I _C =3A		2.5	V
集电极输出电容 Collector output capacitance	C _{ob}	V _{CB} =10V, I=0, f=0.1MHz		300	PF



电参数曲线图 Electrical Characteristic Curve

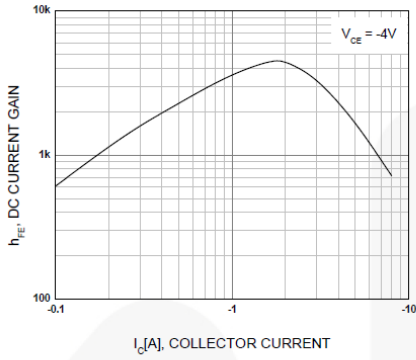

Figure 1. DC Current Gain

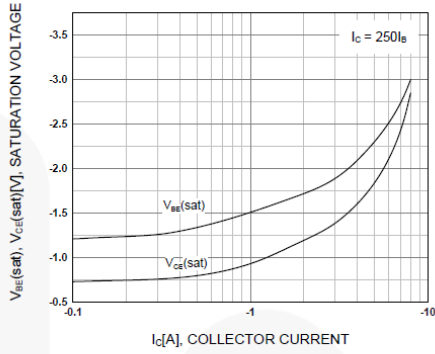

Figure 2. Base-Emitter Saturation Voltage and Collector-Emitter Saturation Voltage

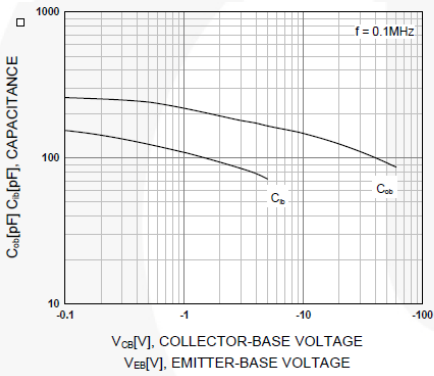

Figure 3. Output and Input Capacitance vs. Reverse Voltage

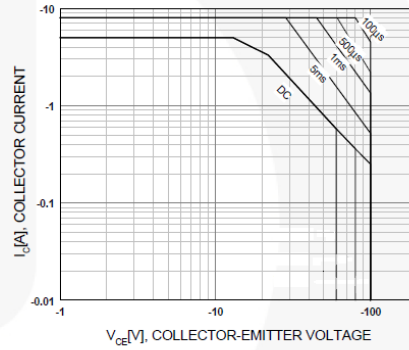

Figure 4. Safe Operating Area

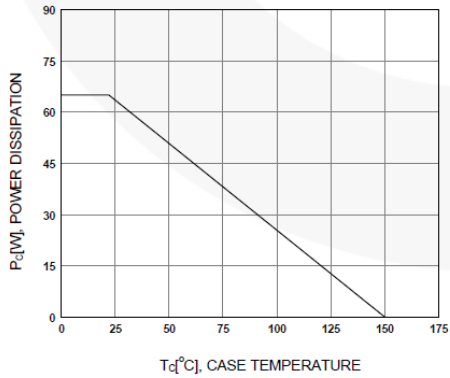

Figure 5. Power Derating



TIP127

封装外形尺寸图 PACKAGE OUTLINE

TO-220

UNIT: mm

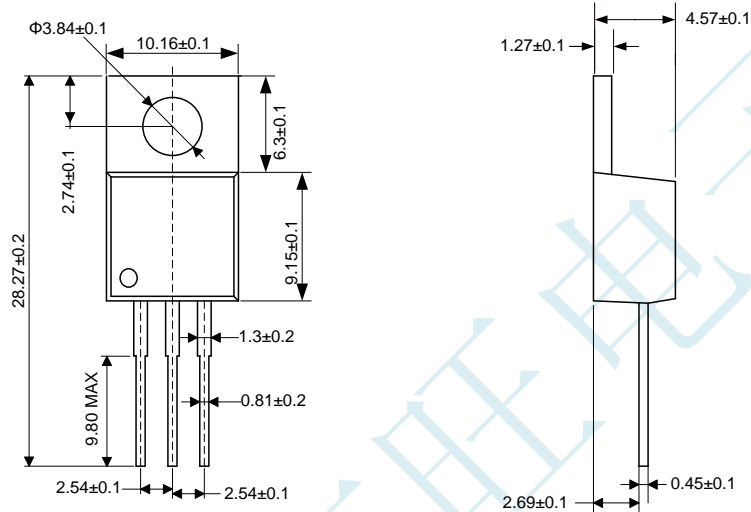

TO-220F

UNIT: mm

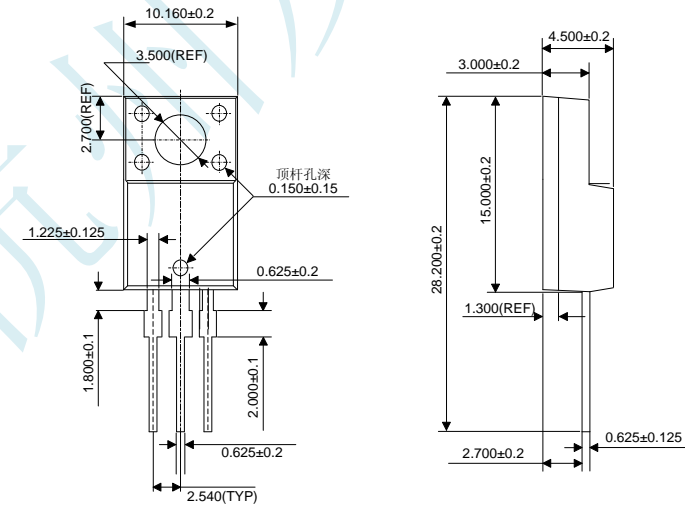

杭州友旺电子有限公司
YOUWANG ELECTRONICS CO.,LTD

2020.03.31 V1.3

TIP127

防静电注意事项 ELECTROSTATIC DISCHARGE CAUTION



These devices have limited built-in ESD protection. The leads should be shorted together or the device placed in conductive foam during storage handling to prevent electrostatic damage to the device.

产品的内置ESD防护有限。产品存储时，应做好静电防护，以防静电对电路造成损坏。

声明 NOTICE

HANGZHOU YOUWANG ELECTRONICS CO.LTD assumes no responsibility for equipment failures that result from using products at values that exceed, even momentarily, rated values (such as maximum ratings, operating condition ranges, or other parameters) listed in products specifications of any and all HANGZHOU YOUWANG ELECTRONICS CO.LTD's products described or contained herein. HANGZHOU YOUWANG ELECTRONICS CO.LTD's products are not designed for use in life support appliances, devices or systems where malfunction of these products can be reasonably expected to result in personal injury. Reproduction in whole or in part is prohibited without the prior written consent of the copyright owner. The information presented in this document does not form part of any quotation or contract, is believed to be accurate and reliable and may be changed without notice.

对于杭州友旺电子有限公司的所有规格的产品，任何由于在使用过程中超过一即使瞬间超过额定数值（如最大值、工况范围，或其他参数）而造成损坏，本公司概不承担任何责任。本公司的产品不可用于人体生命维持设备或系统（这些设备的失灵或故障可能导致人身伤害）。未经授权，不得进行全部或者部分复制。本公司保留说明书的更改权，恕不另行通知。



X-ON Electronics

Largest Supplier of Electrical and Electronic Components

Click to view similar products for [Bipolar Transistors - BJT category](#):

Click to view products by [Youwang Electronics manufacturer](#):

Other Similar products are found below :

[619691C](#) [MCH4017-TL-H](#) [MJ15024/WS](#) [MJ15025/WS](#) [BC546/116](#) [BC556/FSC](#) [BC557/116](#) [BSW67A](#) [HN7G01FU-A\(T5L,F,T](#)
[NJVMJD148T4G](#) [NSVMMBT6520LT1G](#) [NTE187A](#) [NTE195A](#) [NTE2302](#) [NTE2330](#) [NTE2353](#) [NTE316](#) [IMX9T110](#) [NTE63](#) [NTE65](#)
[C4460](#) [SBC846BLT3G](#) [2SA1419T-TD-H](#) [2SA1721-O\(TE85L,F\)](#) [2SA1727TLP](#) [2SA2126-E](#) [2SB1202T-TL-E](#) [2SB1204S-TL-E](#) [2SC5488A-](#)
[TL-H](#) [2SD2150T100R](#) [SP000011176](#) [FMC5AT148](#) [2N2369ADCSM](#) [2SB1202S-TL-E](#) [2SC2412KT146S](#) [2SC4618TLN](#) [2SC5490A-TL-H](#)
[2SD1816S-TL-E](#) [2SD1816T-TL-E](#) [CMXT2207 TR](#) [CPH6501-TL-E](#) [MCH4021-TL-E](#) [BC557B](#) [TTC012\(Q\)](#) [BULD128DT4](#) [JANTX2N3810](#)
[Jantx2N5416](#) [US6T6TR](#) [KSF350](#) [068071B](#)