

UTC3843D/E

LINEAR INTEGRATED CIRCUIT

CURRENT MODE PWM CONTROL CIRCUITS

DESCRIPTION

The UTC3843D/E provides the necessary features to implement off-line or DC to DC fixed frequency current mode control schemes with a minimal external parts count. Internally implemented circuits include under-voltage lockout featuring start up current less than 1mA, a precision reference trimmed for accuracy at the error amp input, logic to insure latched operation, a PWM comparator which also provides current limit control, and a totem pole output stage designed to source or sink high peak current. The output stage, suitable for driving N channel MOSFETs, is low in the off state.

FEATURES

- *Optimized for off-line and DC to DC converts
- *Low start up current(<1mA)
- *Automatic feed forward compensation
- *Pulse-by-Pulse current limiting
- *Enhanced load response characteristics
- *Under-voltage lockout with hysteresis
- *Double pulse Suppression
- *High current totem pole output
- *Internally trimmed bandgap reference
- *500kHz operation
- *Low Ro error amp

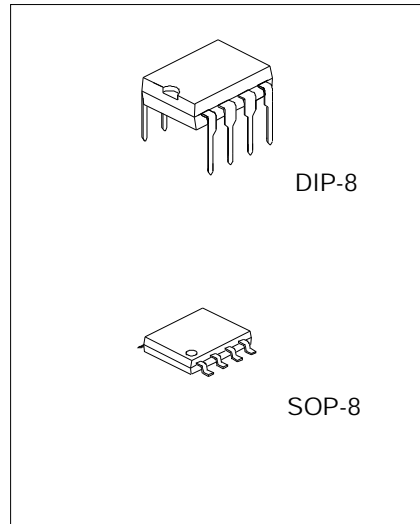

ORDERING INFORMATION

Device	Package
UTC3248D	DIP-8-300-2.54
UTC3248E	SOP-8-225-1.27

BLOCK DIAGRAM

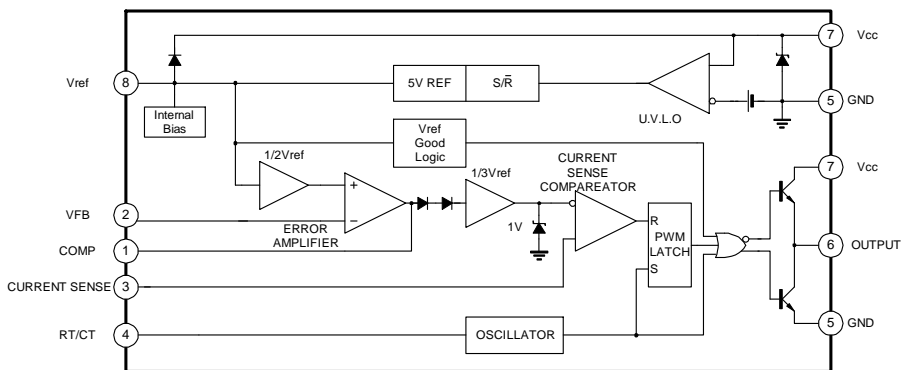

ABSOLUTE MAXIMUM RATINGS($T_a=25^{\circ}\text{C}$)

Characteristic	Symbol	Value	Unit
Supply Voltage(Low Impedence Source)	V _{CC}	30	V
Supply Voltage(I _{CC} <30mA)	V _{CC}	Self Limiting	V
Output Current	I _O	±1	A
Output Energy(capacitive Load)		5	μJ
Analog Inputs(pin 2,3)	V _{I(ANA)}	-0.3 to +6.3	V
Error Amplifier Output Sink Current	I _{SINK(EA)}	10	mA
Power Dissipation	P _D	at T _{amb} ≤25°C 1.0	W
Lead Temperature	T _{lead}	300	°C
Storage Temperature	T _{stg}	-65~+150	°C

Note 1: T_a>25°C, P_D derated with 8mW/°C.

ELECTRICAL CHARACTERISTICS

(0≤T_a≤70°C, V_{CC}=15V, R_T=10kΩ, C_T=3.3nF, unless otherwise specified)

Characteristic	Symbol	Test Conditions	Min	Typ	Max	Units
Reference Section						
Output Voltage	V _{REF}	T _j =25°C, I _o =1mA	4.90	5.00	5.10	V
Line Regulation	ΔV _{REF}	12≤V _{IN} ≤25V		6	20	mV
Load Regulation	ΔV _{REF}	1≤I _o ≤20mA		6	25	mV
Temp Dtability		(Note 2)		0.2	0.4	mV/°C
Total Output Variation		Line, Load, Temp(note 2)	4.82		5.18	μV
Output Noise Voltage	V _{osc}	10Hz≤f≤10kHz, T _j =25°C (note 2)		50		mV
Long term stability		T _a =25°C, 1000Hrs(note 2)		5	25	mV
Output Short Circuit	I _{sc}		-30	-100	-180	mA
Oscillator Section						
Initial Accuracy	f	T _j =25°C	47	52	57	kHz
Voltage Stability	Δf/ΔV _{CC}	12≤V _{CC} ≤25V		0.2	1	%
Temp stability		T _{min} ≤T _A ≤T _{max} (note 2)		5		%
Amplitude	V _{osc}	V _{pin 4} peak to peak		1.7		V
Error Amplifier Section						
Input Voltage	V _{I(EA)}	V _{pin 1} =2.5V	2.42	2.50	2.58	V
Input Bias current	I _{BIAS}			-0.3	-2	μA
AVOL		2 ≤V _o ≤4V	60	90		dB
Unity Gain Bandwidth		T _j =25°C (note 2)	0.7	1		mHz
PSRR		12≤V _{CC} ≤25V	60	70		dB
Output Sink Current	I _{sink}	V _{pin 2} =2.7V, V _{pin 1} =1.1V	2	6		mA
Output Source Current	I _{source}	V _{pin 2} =2.3V, V _{pin 1} =5V	-0.5	-0.8		mA
V _{out High}	V _{OH}	V _{pin 2} =2.3V, R _L =15kΩ to GND	5	6		V
V _{out Low}	V _{OL}	V _{pin 2} =2.7V, V _{pin 1} =1.1V		0.7	1.1	V
Current Sense section						
Gain	G _V	(note 3,4)	2.85	3	3.15	V/V
Maximum Input signal	V _{I(MAX)}	V _{pin 1} =5V(note 3)	0.9	1	1.1	V
PSRR		12≤V _{CC} ≤25V		70		dB
Input Bias Current	I _{BIAS}			-2	-10	μA
Delay to Output		V _{pin 3} =0 to 2V		150	300	ns
Output Section						
Output low Level	V _{OL}	I _{sink} =20mA		0.1	0.4	V
		I _{sink} =200mA		1.5	2.2	V

(continued)

Characteristic	Symbol	Test Conditions	Min	Typ	Max	Units
Output High Level	VoH	I _{source} =20mA	13	13.5		V
		I _{source} =200mA	12	13.5		V
Rise Time	t _R	T _j =25°C, C _L =1nF(note 2)		50	150	ns
Fall Time	t _F	T _j =25°C, C _L =1nF(note 2)		50	150	ns
UVLO Saturation		V _{cc} =5V, I _{sink} =10mA		0.7	1.2	V
Under-Voltage Lockout Output Section						
Start Threshold	V _{TH} (ST)		7.8	8.4	9.0	V
Min. Operating Voltage After Turn On	V _{OPR} (min)		7.0	7.6	8.2	V
PWM Section						
Maximum duty Cycle	D(MAX)		95	97	100	%
Minimum Duty Cycle	D(MIN)				0	%
Total Standby Current						
Start-up Current	I _{ST}			0.5	1	mA
Operating Supply Current	I _{CC} (opr)	V _{pin 2} =V _{pin 3} =0V		11	17	mA
V _{cc} Zener Voltage	V _Z	I _{cc} =25mA		34		V

note 2: These parameters, although guaranteed, are not 100% tested in production.

note 3: Parameters measured at trip point of latch with V_{pin 2}=0.

note 4: Gain defined as:

$$A = \frac{\Delta V_{pin 1}}{\Delta V_{pin 3}} ; 0 \leq V_{pin 3} \leq 0.8V$$

note 5: Adjust V_{cc} above the start threshold before setting at 15V.

OPEN-LOOP LABORATORY TEST CIRCUIT

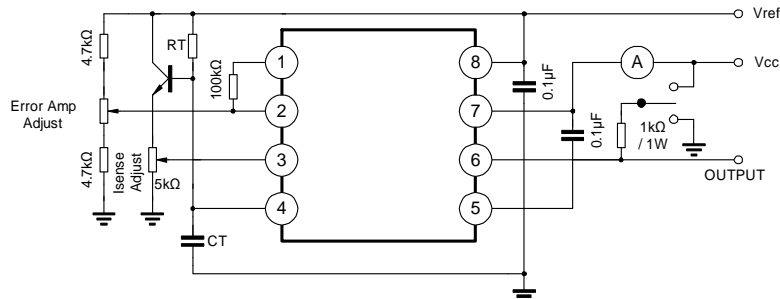

High peak current associated with capacitive loads necessitate careful grounding techniques. Timing and bypass capacitors should be connected close to pin 5 in

single point GND. The transistor and 5kΩ potentiometer are used to sample the oscillator waveform and apply an adjustable Ramp to Pin 3.

UNDER-VOLTAGE LOCKOUT

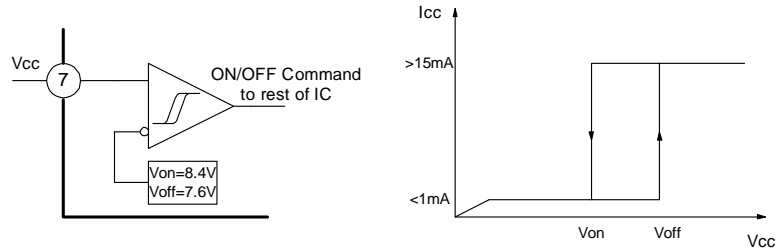

During Under-Voltage Lockout, the output driver is biased to a high impedance state. Pin 6 should be shunt

to GND with a bleeder resistor to prevent activating the power switch with output leakage currents.

ERROR AMPLIFIER CONFIGURATION

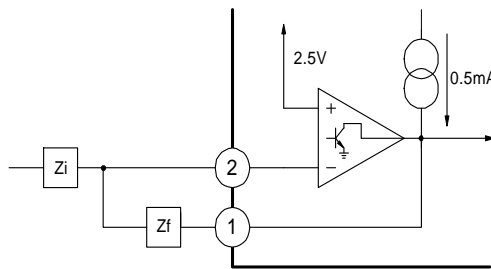

Error amplifier can source or sink up to 0.5mA

CURRENT SENSE CIRCUIT

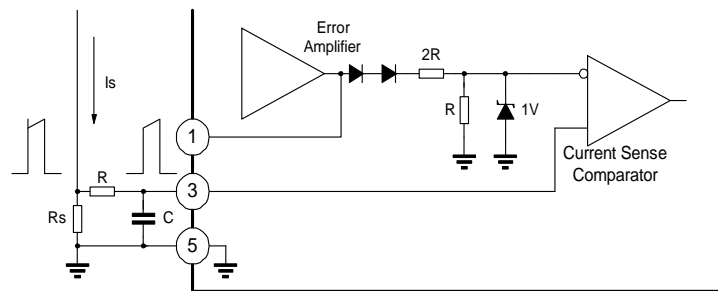

Peak current (I_s) determined by the formula:
 $I_{smax} = 10V/R_s$.

A small RC filter be required to suppress switch transients.

SLOPE COMPENSATION

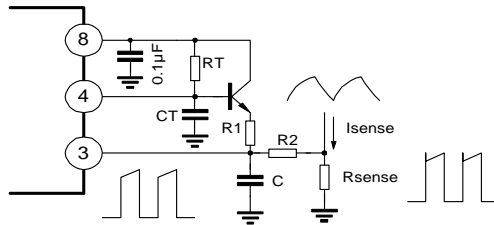

A fraction of the oscillator ramp can be resistively summed with the current sense signal to provide slope compensation for converters requiring duty cycles over

50%. Note that capacitor C, forms a filter with R2 to suppress the leading edge switch spikes.

OSCILLATOR SECTION

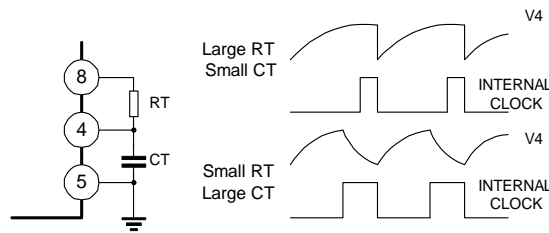

Deadtime VS C_T ($R_T > 5k\Omega$)

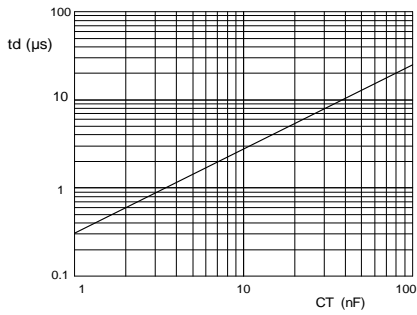

Timing Resistance Vs Frequency

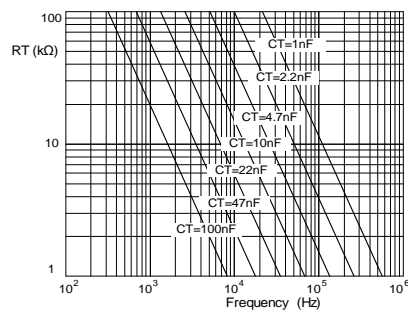

SHUTDOWN TECHNIQUES

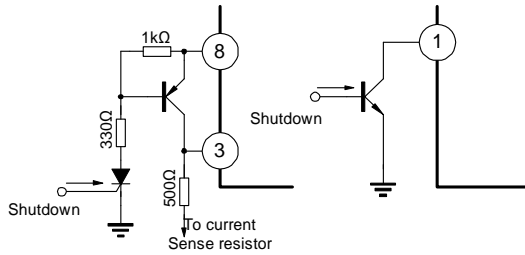

Shutdown UTC3843D/E can be accomplished by two methods; either raise pin 3 above 1V or pull Pin 1 below a voltage two diode drops above ground. Either method caused the output of PWM comparator to be high (refer to block diagram). The PWM latch is reset dominant so that the output will remain low until the next clock cycle after the shutdown condition at pins 3 and/or 1 is removed. In one example, an externally latched shutdown may be accomplished by adding an SCR which is reset by cycling Vcc below the lower UVLO threshold. At this point the reference turns off allowing the SCR to reset.

TYPICAL PERFORMANCE CHARACTERISTICS

Vref Temperature Drift

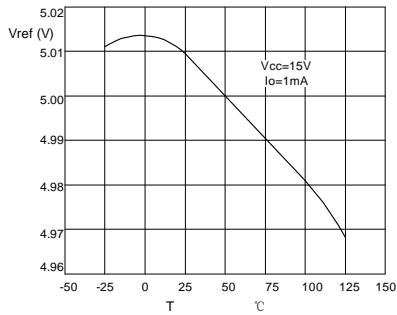

Istart Temperature Drift

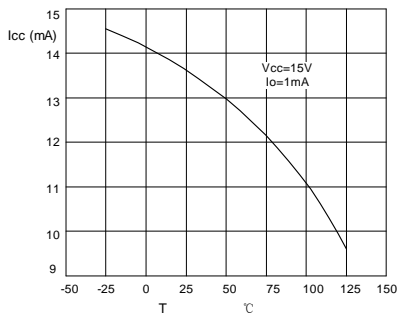
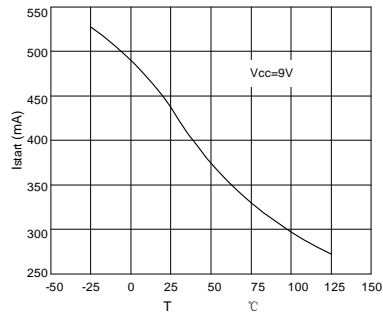

Icc Temperature Drift

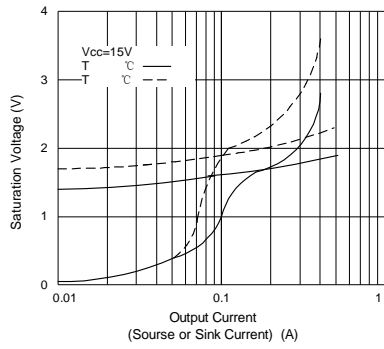

Output Saturation Characteristics

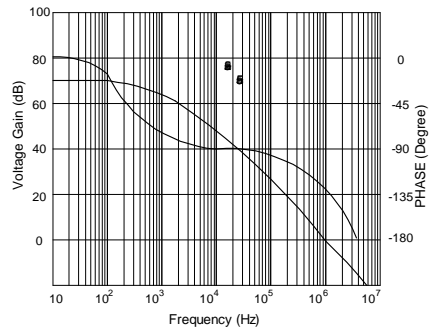

Error Amplifier Open-Loop Frequency Response

PACKAGE DIMENSIONS

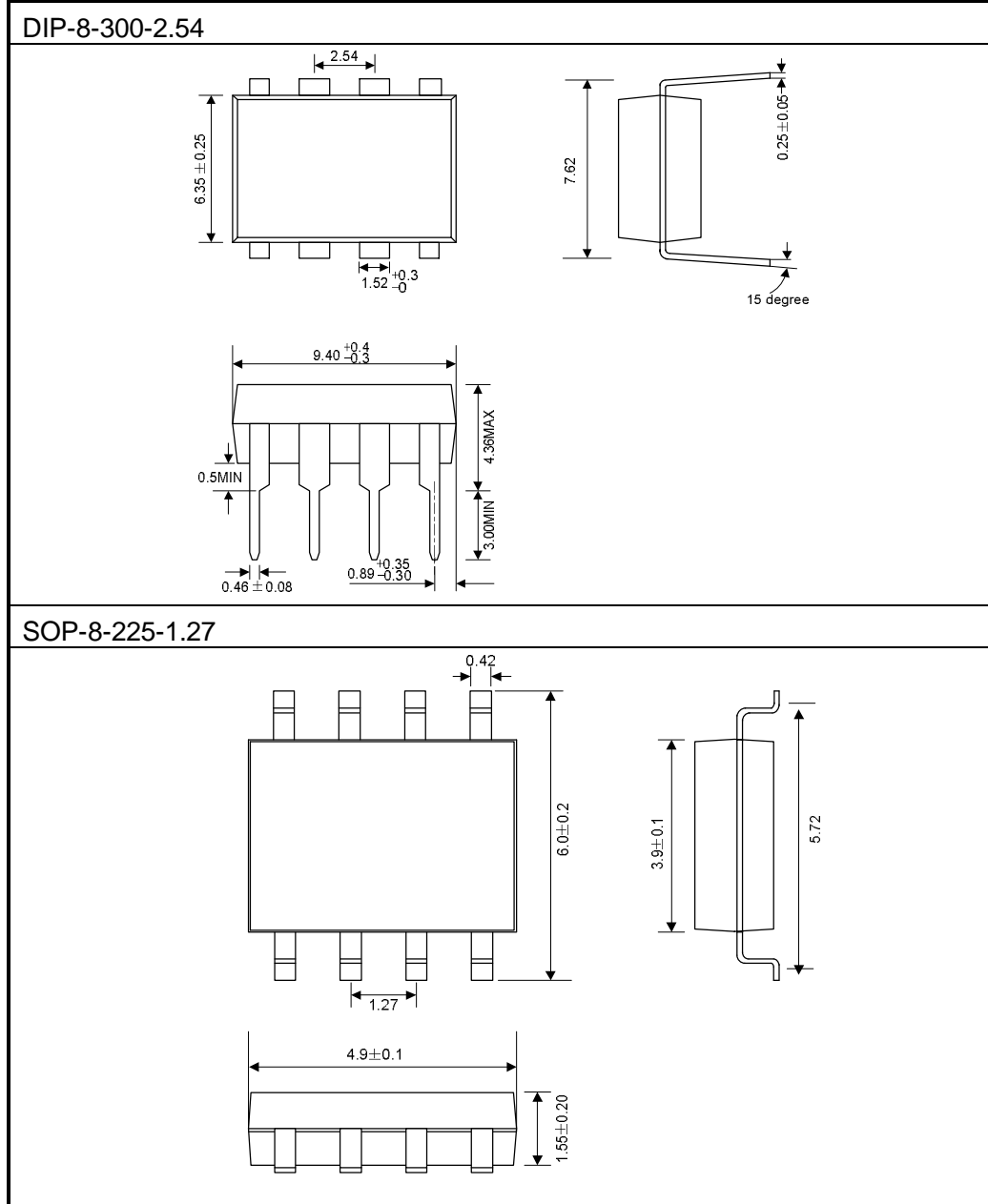

Attach

Revision History

Data	REV	Description	Page
	1.0	Original	
2006.07.11	1.1	Add "OREDRING INFORMATION" and package outline"SOP-8"	1,8

X-ON Electronics

Largest Supplier of Electrical and Electronic Components

Click to view similar products for [Switching Controllers](#) category:

Click to view products by [Youwang Electronics](#) manufacturer:

Other Similar products are found below :

[NCP1218AD65R2G](#) [NCP1234AD100R2G](#) [NCP1244BD065R2G](#) [NCP1336ADR2G](#) [NCP6153MNTWG](#) [NCP81005MNTWG](#)
[NCP81101BMNTXG](#) [NCP81205MNTXG](#) [SJ6522AG](#) [SJE6600](#) [AZ7500BMTR-E1](#) [IR35215MTRPBF](#) [SG3845DM](#) [NCP4202MNR2G](#)
[NCP4204MNTXG](#) [NCP6132AMNR2G](#) [NCP81102MNTXG](#) [NCP81141MNTXG](#) [NCP81203MNTXG](#) [NCP81206MNTXG](#) [NX2155HCUPTR](#)
[UBA2051C](#) [IR35201MTRPBF](#) [FSL4110LRLX](#) [NCP1015ST65T3G](#) [NCP1240AD065R2G](#) [NCP1240FD065R2G](#) [NCP1336BDR2G](#)
[NCP1361BABAYSNT1G](#) [NCP1230P100G](#) [NX2124CSTR](#) [SG2845M](#) [NCP1366BABAYDR2G](#) [NCP81101MNTXG](#) [TEA19362T/1J](#)
[NCP81174NMNTXG](#) [NCP4308DMTTWG](#) [NCP4308DMNTWG](#) [NCP4308AMTTWG](#) [NCP1366AABAYDR2G](#) [NCP1256ASN65T1G](#)
[NCP1251FSN65T1G](#) [NCP1246BLD065R2G](#) [MB39A136PFT-G-BND-ERE1](#) [NCP1256BSN100T1G](#) [LV5768V-A-TLM-E](#)
[NCP1365BABCYDR2G](#) [NCP1365AABCYDR2G](#) [IR35204MTRPBF](#) [MCP1633T-E/MG](#)