

Description

YTLD2502C is a FBAR duplexer designed with Film Bulk Acoustic Resonator (FBAR) technology for LTE handsets, mobile routers to get good application performance.

YTLD2502C enable LTE application demanding high power handling for Transmit Port , high sensitivity for Receive Port, stringent linearity requirement and low insertion loss for high wi-fi coexistence and critical out-of-band attenuation.



8 Pin 1.8 x 1.4 x 0.61mm Package

Features

- Miniature Size
1.8 mm x 1.4 mm x 0.61 mm
- Insertion Loss:
 - Tx 2.0 dB Typ.
 - Rx 2.0 dB Typ.
- Tx-RX Isolation:
 - Tx Pass Band 50 dB Typ.
 - Rx Pass Band 56 dB Typ.
- Tx Input Power
 - +30 dBm CW for 5000h @ +55°C
- ESD protection ability: Class1C
- Moisture Sensitivity: MSL3
- Storage Temperature: -40 to +85 °C

Environmental

- Full implement with RoHS compliant
- Lead Free (Pb free)



Functional Block Diagram (Top Thru

View)

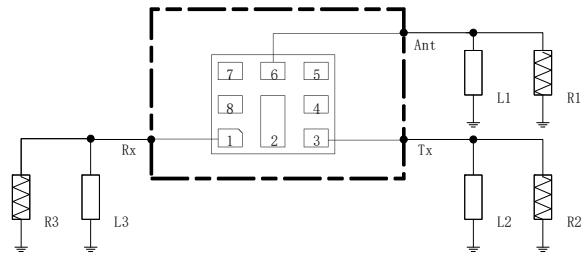

Reference Des.	Value	Description
R1	50ohm	
R2	50ohm	
R3	50ohm	
L1	1.9nH	Ideal Inductor
L2	5.6nH	Ideal Inductor
L3	3.0nH	Ideal Inductor

Pin Connection

No.	Function
1	Rx
3	Tx
6	Ant
2,4,5,7,8	Ground



Electrical Specification

Transmit Port to Antenna Port				
Parameter (Operation Temperature: -20 to +85 °C)	Min	Typ*	Max	Unit
Insertion Loss (2500~2570MHz)	/	2.0	2.8	dB
Ripple (2500~2570MHz)	/	0.7	1.5	dB
VSWR (2500~2570MHz,ANT Port)	/	1.5	1.8	\
VSWR (2500~2570MHz,TX Port)	/	1.5	1.8	\
Absolute Attenuation (500~8000MHz)				
(500~1560MHz)	31	36	/	dB
(1565 ~1606MHz)	31	36	/	dB
(1805~1880MHz)	29	34	/	dB
(2110~2170MHz)	30	35	/	dB
(2300~2400MHz)	32	35	/	dB
(2400~2472MHz)	37	40	/	dB
(2472~2481MHz)	25	35	/	dB
(2620~2690MHz)	49	52	/	dB
(3400~3600MHz)	48	53	/	dB
(5000~5140MHz, <i>2fo</i>)	32	37	/	dB
(5600~7200MHz)	24	31	/	dB
(7500~7710MHz, <i>3fo</i>)	26	31	/	dB
Antenna Port to Receive Port				
Parameter (Operation Temperature: -20 to +85 °C)	Min	Typ*	Max	Unit
Insertion Loss (2620~2690MHz)	/	2.0	2.8	dB
Ripple (2620~2690MHz)	/	0.8	1.5	dB
VSWR (2620~2690MHz,ANT Port)	/	1.2	1.5	\
VSWR (2620~2690MHz,RX Port)	/	1.2	1.5	\
Absolute Attenuation (500~8000MHz)				
(500~1680MHz)	46	51	/	dB
(1710~1785MHz)	43	48	/	dB
(1920~1980MHz)	39	44	/	dB
(2400~2500MHz)	43	48	/	dB
(2500~2570MHz)	46	49	/	dB
(2750~4900MHz)	45	50	/	dB
(5240~5380MHz, <i>2fo</i>)	34	39	/	dB
(5400~7400MHz)	14	21	/	dB
(7860~7965MHz, <i>3fo</i>)	14	21	/	dB



Transmit Port to Receive Port

Parameter(Operation Temperature: -20 to +85 °C)	Min	Typ*	Max	Unit
Isolation				
2500~2570MHz	47	50	/	dB
2620~2690MHz	53	56	/	dB

*Data is the integrated value of the linear s-parameter over indicated band

* Typical value at 25±3 °C



Typical Performance at Tc=25°C

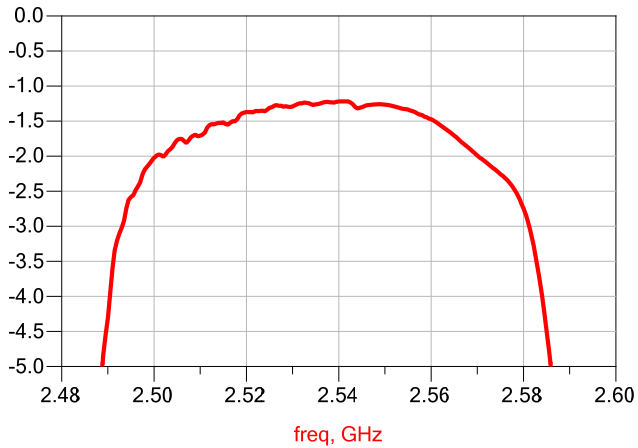

Figure1. TX-ANT Passband

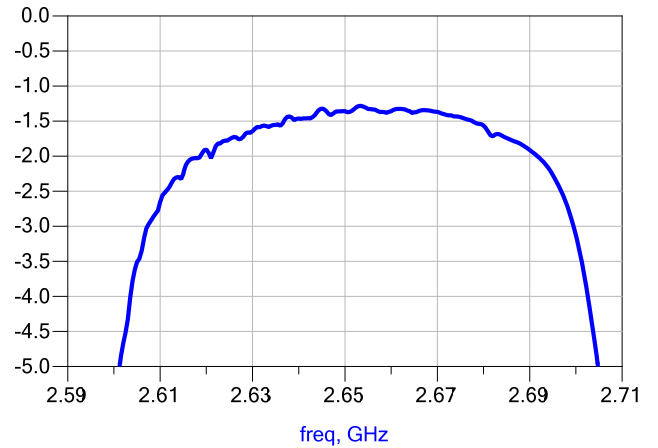

Figure2. ANT-RX Passband

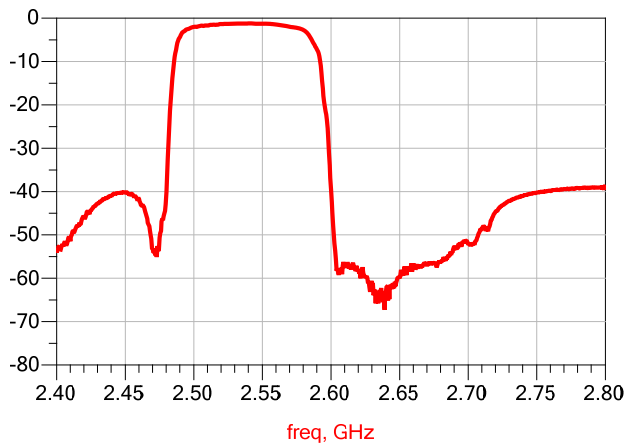

Figure3. TX-ANT

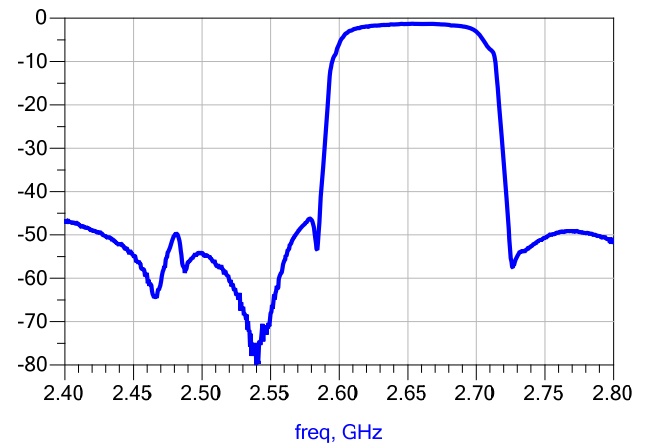

Figure4. ANT-RX

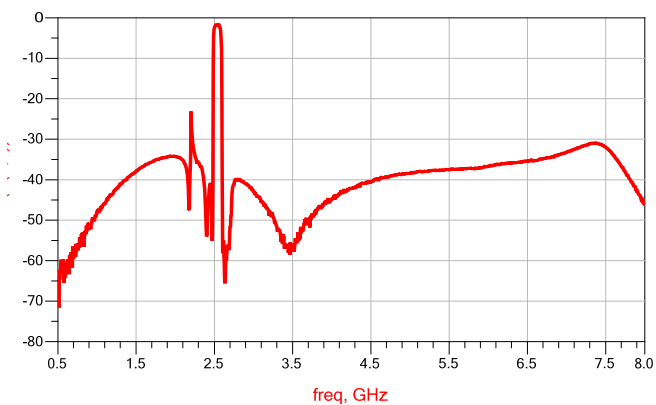

Figure5. TX-ANT Wideband

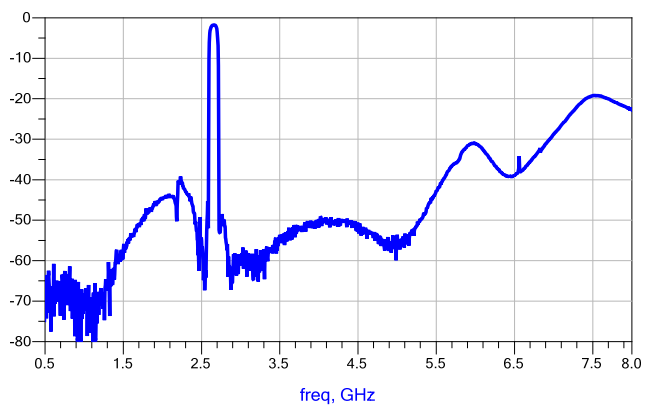

Figure6. ANT-RX Wideband



Typical Performance at Tc=25°C

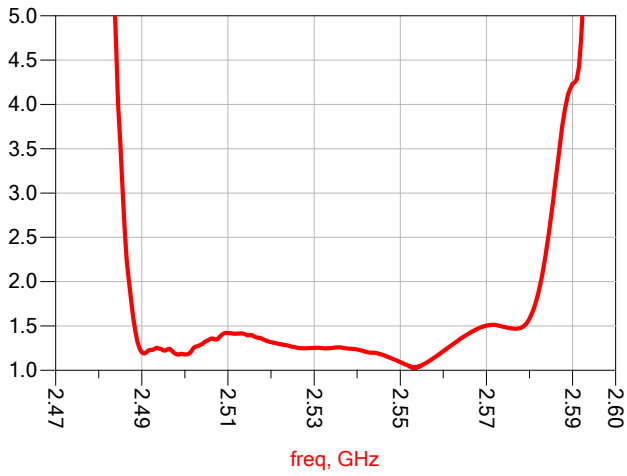

Figure7. TX Port VSWR

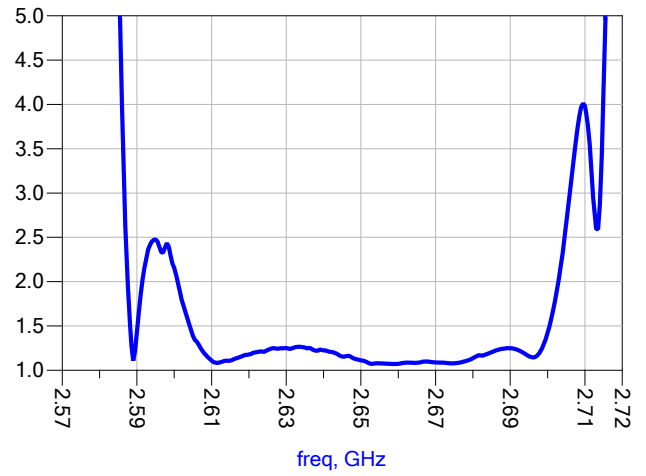

Figure8. RX Port VSWR

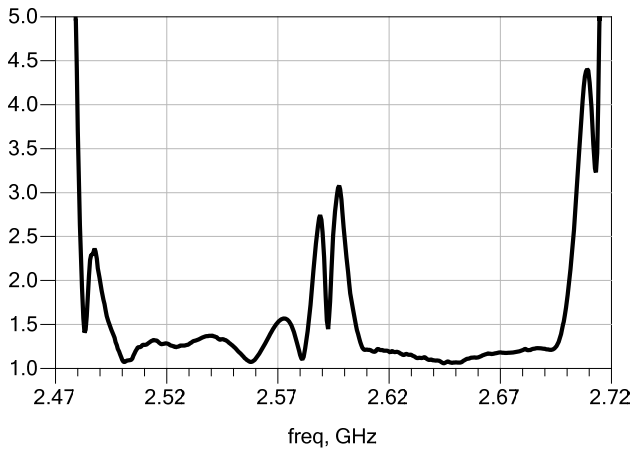

Figure9. Ant Port VSWR



Figure10. TX - RX Isolation



Typical Performance at Tc=25°C

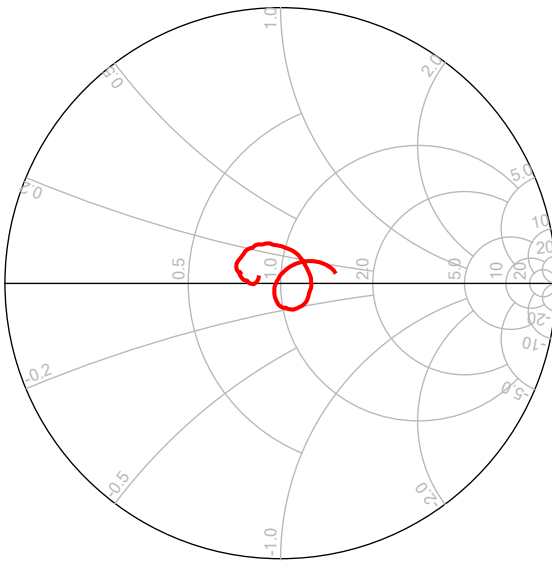

freq (2.500GHz to 2.570GHz)

Figure11. TX Smith Chart

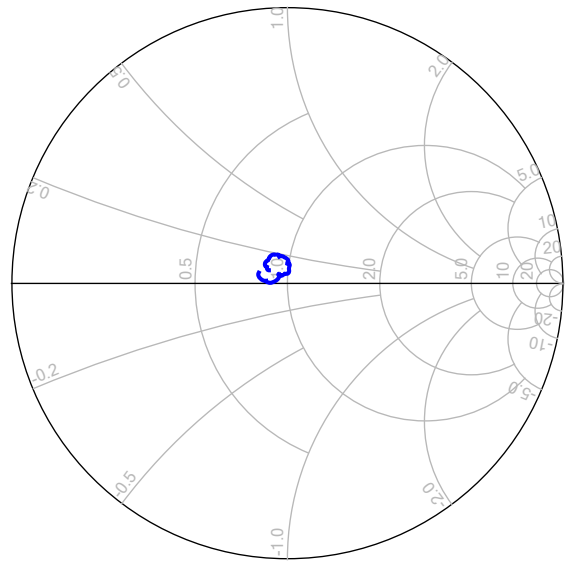

freq (2.620GHz to 2.690GHz)

Figure12. RX Smith Chart

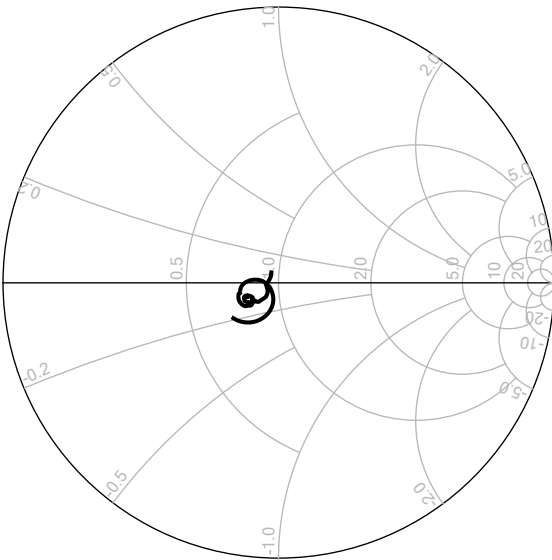

freq (2.500GHz to 2.570GHz)

Figure13. Ant (Tx Pass Band) Smith Chart

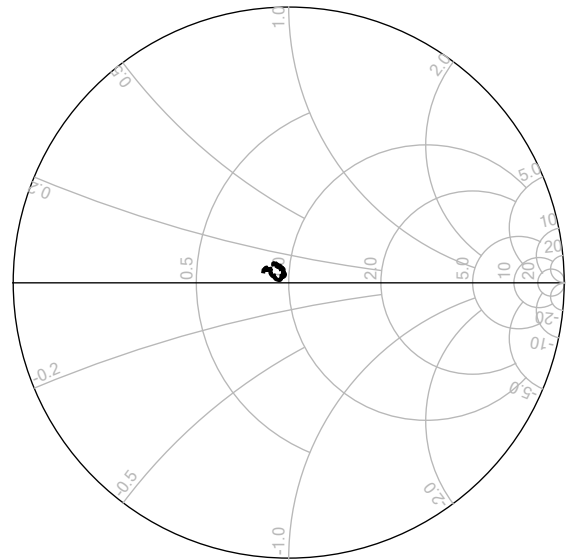

freq (2.620GHz to 2.690GHz)

Figure14. Ant (Rx Pass Band) Smith Chart



Pac kage Outline

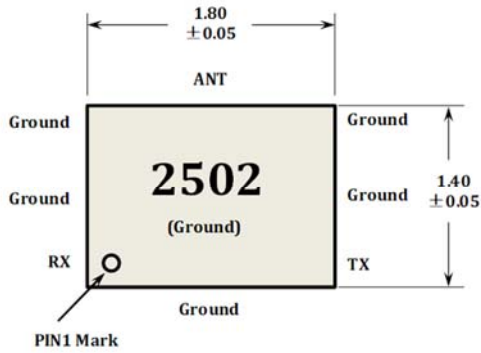

Top View

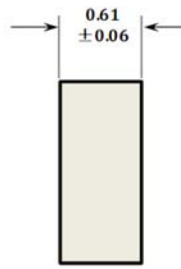

Side View

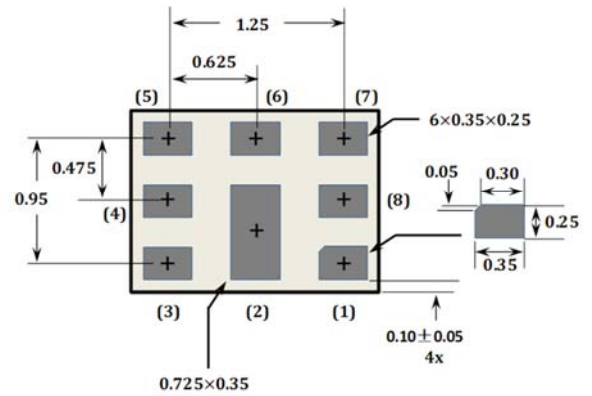

Bottom View

Note:

1. Dimension: mm
2. Dimensions nominal unless otherwise noted
3. Contact area are gold plated
4. Pad(1)(2) is single size, others are same size
5. 2502 is product code

No.	Function
1	Rx
3	Tx
6	Ant
2,4,5,7,8	Ground

Order Information

P/N	Qty/Reel	Container
YTLD2502C	4000	7 inch Reel



Packing

1. Tape Dimension

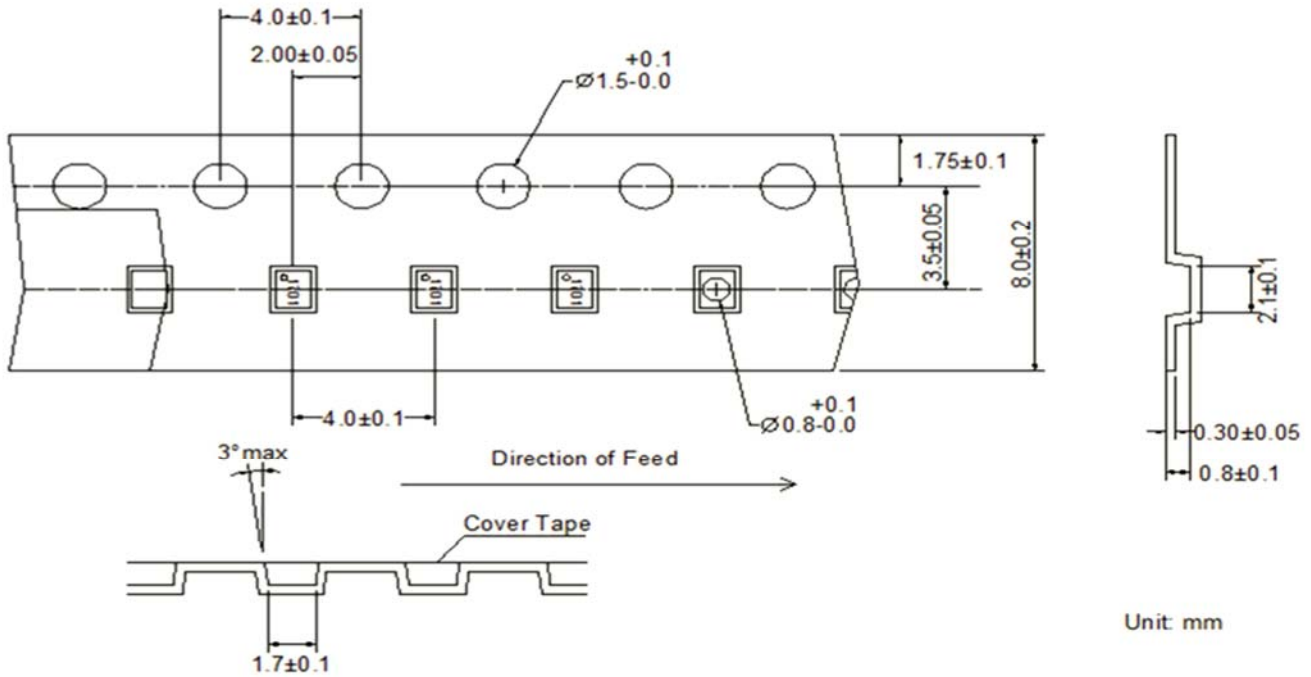

2. Reel Dimension

4000Pcs/Reel

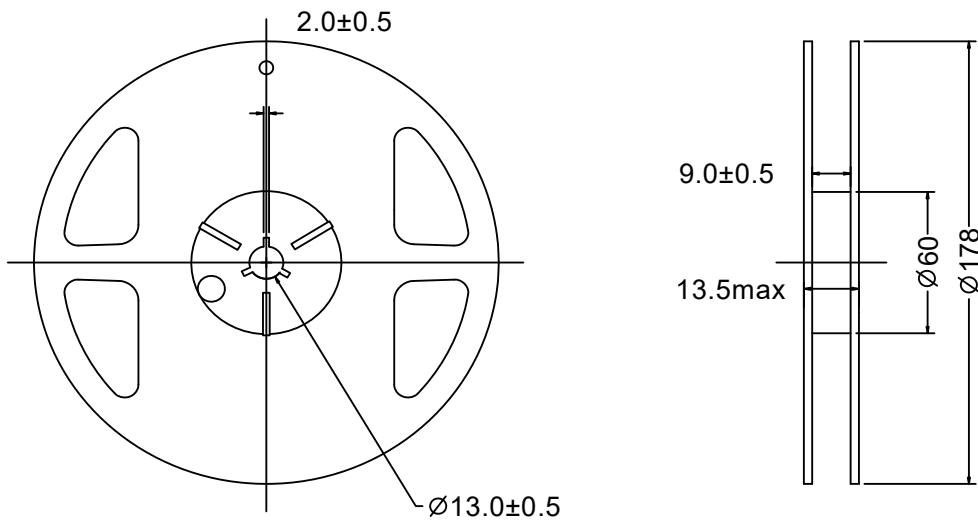
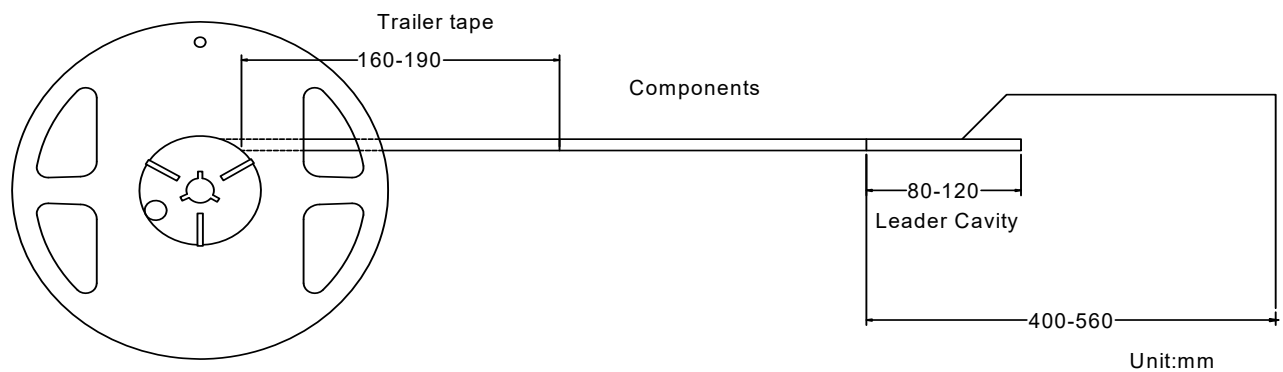

Recommended Reflow Profile

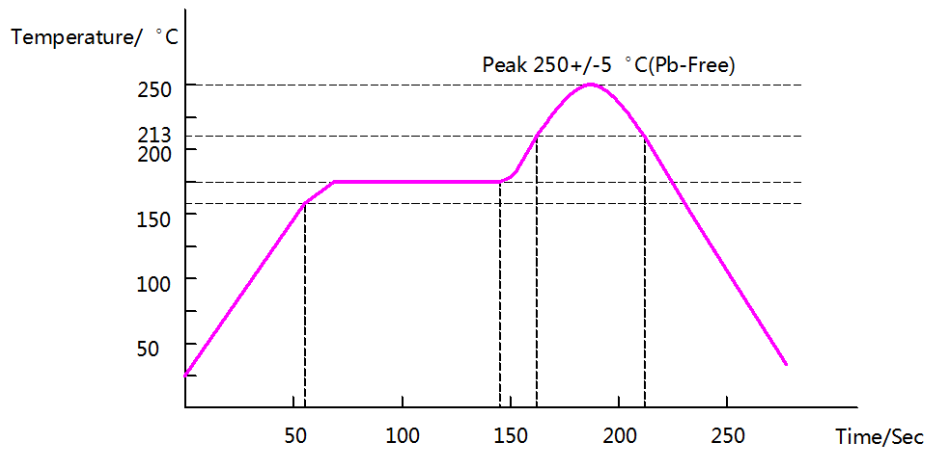

X-ON Electronics

Largest Supplier of Electrical and Electronic Components

Click to view similar products for [Signal Conditioning category](#):

Click to view products by [YTL manufacturer](#):

Other Similar products are found below :

[MAPDCC0001](#) [MAPDCC0004](#) [PD0409J5050S2HF](#) [HHS-109-PIN](#) [AFS14A30-2185.00-T3](#) [AFS14A35-1591.50-T3](#) [DS-323-PIN](#) [DSS-313-PIN](#) [B39321R801H210](#) [1A0220-3](#) [JP510S](#) [LFB212G45SG8C341](#) [LFB322G45SN1A504](#) [LFL182G45TC3B746](#) [SF2159E](#) [30057](#)
[AFS1575.42S4-T](#) [FM-104-PIN](#) [CER0813B](#) [MAPDCC0005](#) [3A325](#) [40287](#) [41180](#) [ATB3225-75032NCT](#) [BD0810N50100AHF](#) [JHS-115-PIN](#)
[DC0710J5005AHF](#) [DC2327J5005AHF](#) [43020](#) [LFB2H2G60BB1C106](#) [LFL15869MTC1B787](#) [X3C19F1-20S](#) [XC3500P-20S](#) [10013-20](#)
[SF2194E](#) [CDBLB455KCAX39-B0](#) [TGL2208-SM, EVAL](#) [RF1353C](#) [051157-0000](#) [PD0922J5050D2HF](#) [1E1305-3](#) [1F1304-3S](#) [1G1304-30](#)
[B0922J7575AHF](#) [10017-3](#) [TP-103-PIN](#) [BD1222J50200AHF](#) [BD1722J50100AHF](#) [2450DP39K5400E](#) [BD0810J50150AHF](#)