

## Description

YTLP2416E is a Wi-Fi band filter, which is designed with Film Bulk Acoustic Resonator (FBAR) technology. The product can provide low insertion loss and steep skirt to enables coexistence of Wi-Fi and LTE signals within the same device or in close proximity to one another. The typical insertion loss in the pass band is less than 1.4dB. Typical rejection at the LTE Band 38 and LTE Band 7 and 41 is more than 42dB, at the LTE Band 40 is more than 41dB.

For the chip package, the YTLP2416E uses advanced module packing techniques to achieve the industry standard 1.1x0.9x0.6mm footprint, include bumping and flip chip.

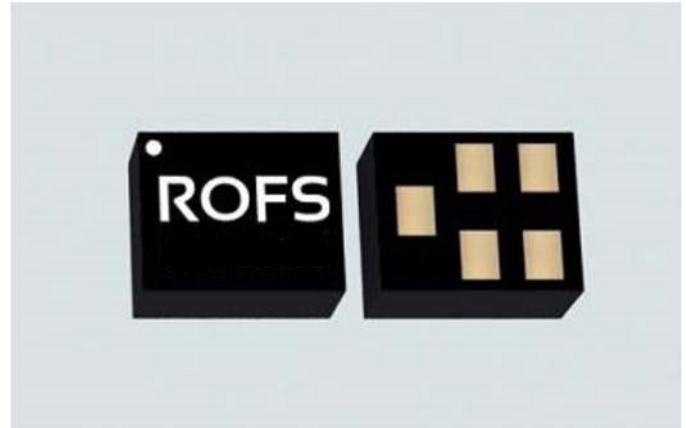

## Functional Block Diagram

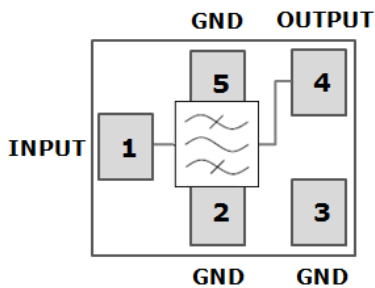

## Pin Connection

No.	Function
1	Input
4	Output
2,3,5	Ground

## Features

- For Wi-Fi - LTE coexistence application
- Plastic Chip Scale Package(CSP)
- Miniature Size: 1.1mm x 0.9 mm x 0.6 mm
- Fast Roll-off from Wi-Fi to near LTE Bands
- High Rejection at LTE bands.
- Low Temperature Coefficient of Frequency
- Storage temperature range: -40 to +150 °C
- Excellent ESD protection ability: Class 1C
- Moisture Sensitivity : MSL3

## Applications

- Wi-Fi bandpass filter enables the coexistence of (LTE/TD-LTE) & Wi-Fi
- ISM band applications such as Smart Meters
- Portable Hotspots and Mobile Routers

## Environmental

- Full implement with RoHS compliant
- Lead Free (Pb free)



## Electrical Specifications

Parameter(Operable Temperature:-25 to +85°C)	Min	Typ <sup>(1)</sup>	Max	Unit
Insertion Loss(2402.5 ~ 2421.5 MHz)	\	1.3	1.9	dB
Insertion Loss(2407.5 ~ 2476.5 MHz)	\	1.1	1.7	dB
Insertion Loss(2462.5 ~ 2481.5 MHz)	\	1.4	2.2	dB
Ripple(2402.5 ~ 2421.5 MHz)	\	0.6	1.0	dB
Ripple(2407.5 ~ 2476.5 MHz)	\	0.6	1.0	dB
Ripple(2462.5 ~ 2481.5 MHz)	\	0.8	1.2	dB
VSWR(2402.5 ~ 2481.5 MHz)	\	1.2	1.7	\
<b>Absolute Attenuation</b>			\	
800 ~ 2000 MHz	32	37	\	dB
2000 ~ 2170 MHz	22	35	\	dB
2300 ~ 2370 MHz	45	53	\	dB
2370 ~ 2375 MHz	45	50	\	dB
2375 ~ 2380 MHz	22	41	\	dB
2500 ~ 2505 MHz	50	61	\	dB
2505 ~ 2570 MHz	46	60	\	dB
2570 ~ 2620 MHz	39	45	\	dB
2620 ~ 2690 MHz	38	42	\	dB
4800 ~ 5805 MHz	40	43	\	dB
RF Input Power <sup>(2)</sup> (2402.5 ~ 2481.5 MHz)	\	\	28	dBm

(1) **Typ Data** is the integrated value of the linear S-parameter over indicated band.

(2) Input power applied for a minimum of 5,000 hrs at 55°C in the specified frequency band



Typical Performance at Tc=25 °C

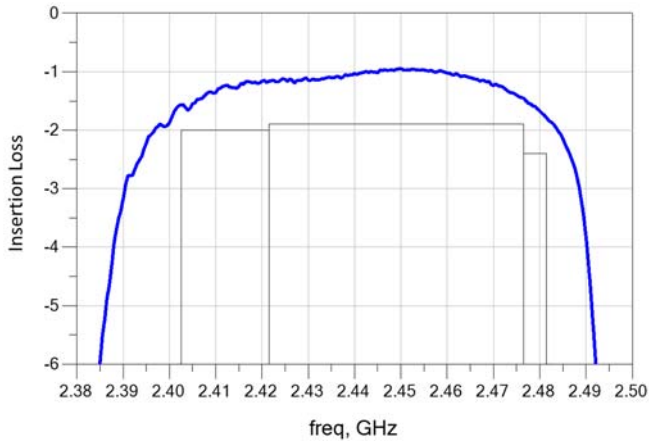

Figure.1 Passband Insertion Loss

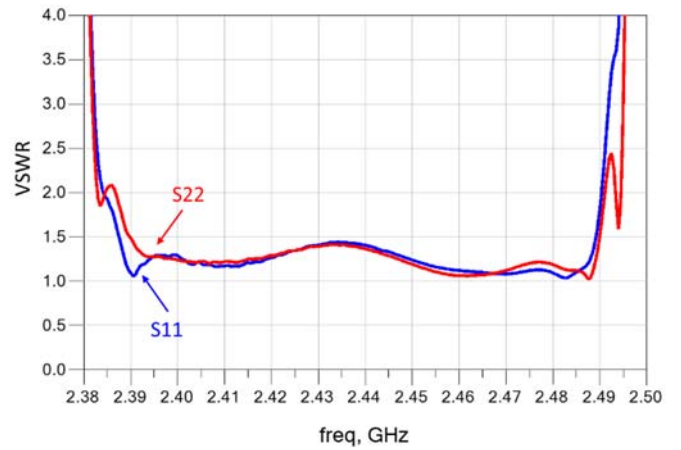

Figure.2 VSWR

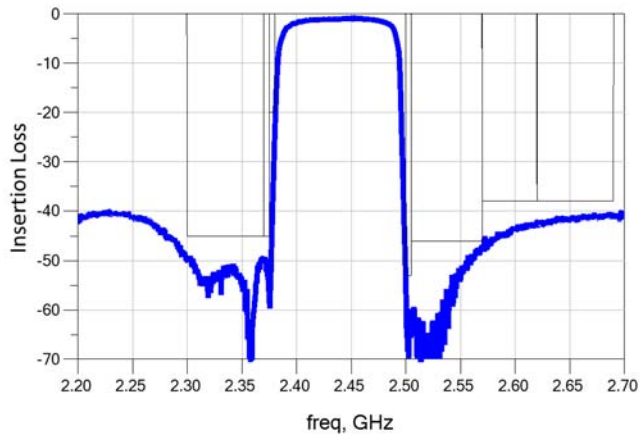

Figure.3 Narrowband Insertion Loss

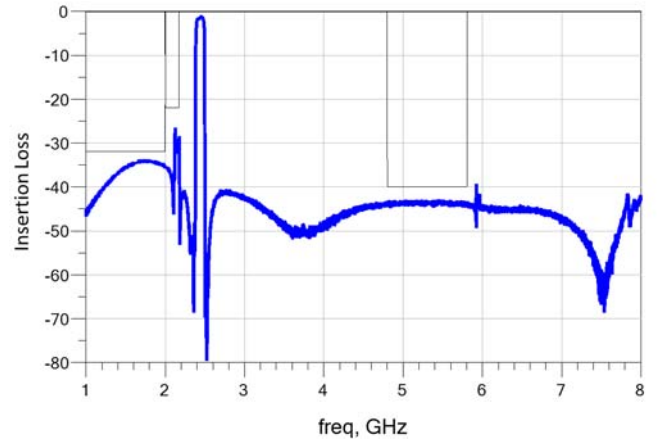
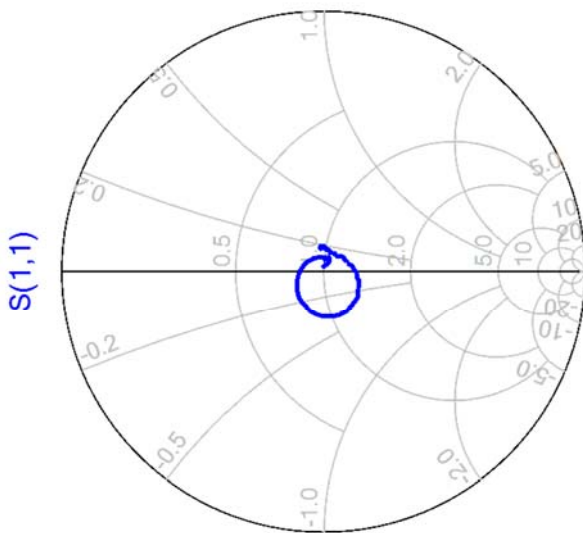
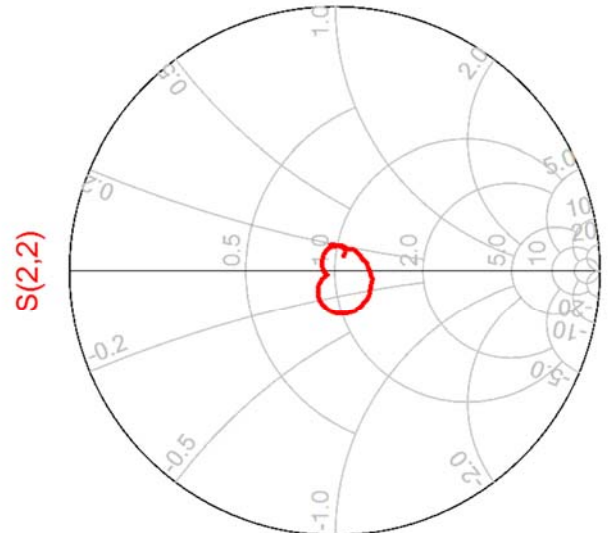

Figure.4 Wideband Insertion Loss



freq (2.402GHz to 2.482GHz)

Figure.5 Input Smith Chart S11



freq (2.402GHz to 2.482GHz)

Figure.6 Output Smith Chart S22



### Package Outline Drawing

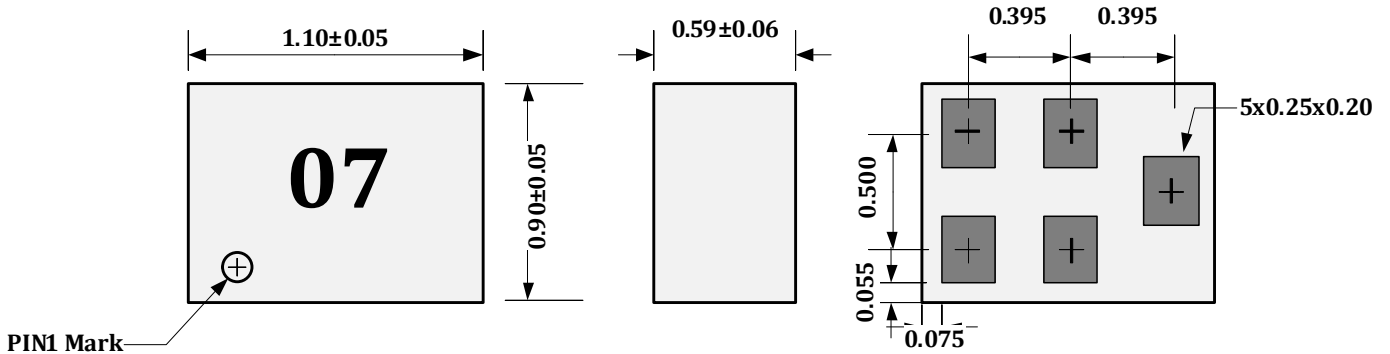

PIN1 Mark

#### Notes:

1. Dimension: mm
2. Dimensions nominal unless otherwise noted
3. Contact area are gold plated
4. Pad(1) to (5) are same size
5. XX is ROFS inside code

#### Pin Connection:

- |       |        |
|-------|--------|
| 1     | Input  |
| 4     | Output |
| 2.3.5 | Ground |

### Test Circuit

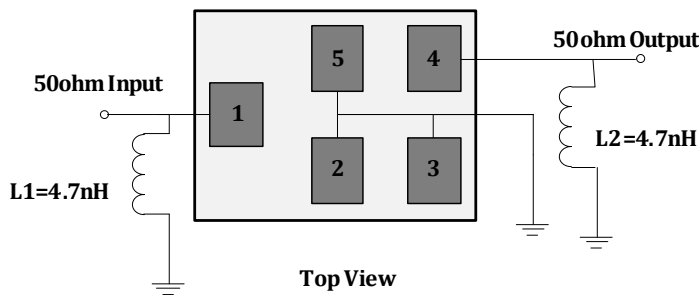

#### Notes:

1. Matching component values shown are ROFS evaluation board results, please adjust component values by the actual use environment.

### PCB Footprint

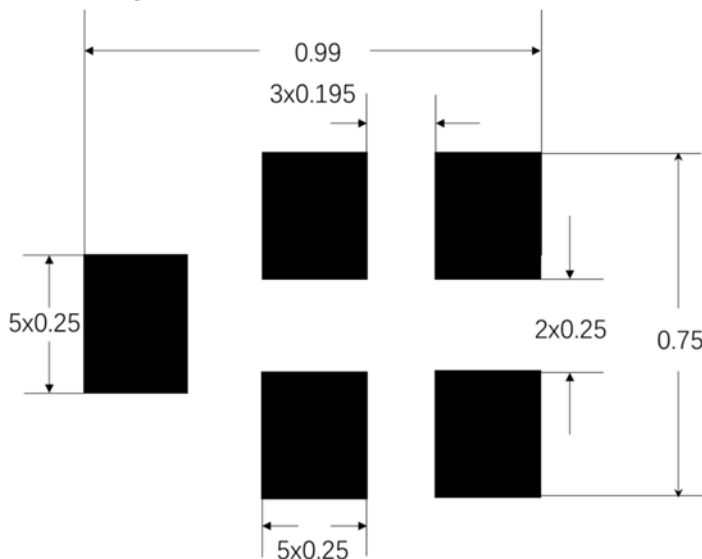

#### Notes:

1. Black indicates metallized area.
2. This footprint represents a recommendation only, some modification may be necessary to suit end user assembly materials and processes.
3. For solder pad recommendation see mechanical information.
4. Dimensions shown are nominal in millimeters.



## Packing

### 1. Tape Dimension

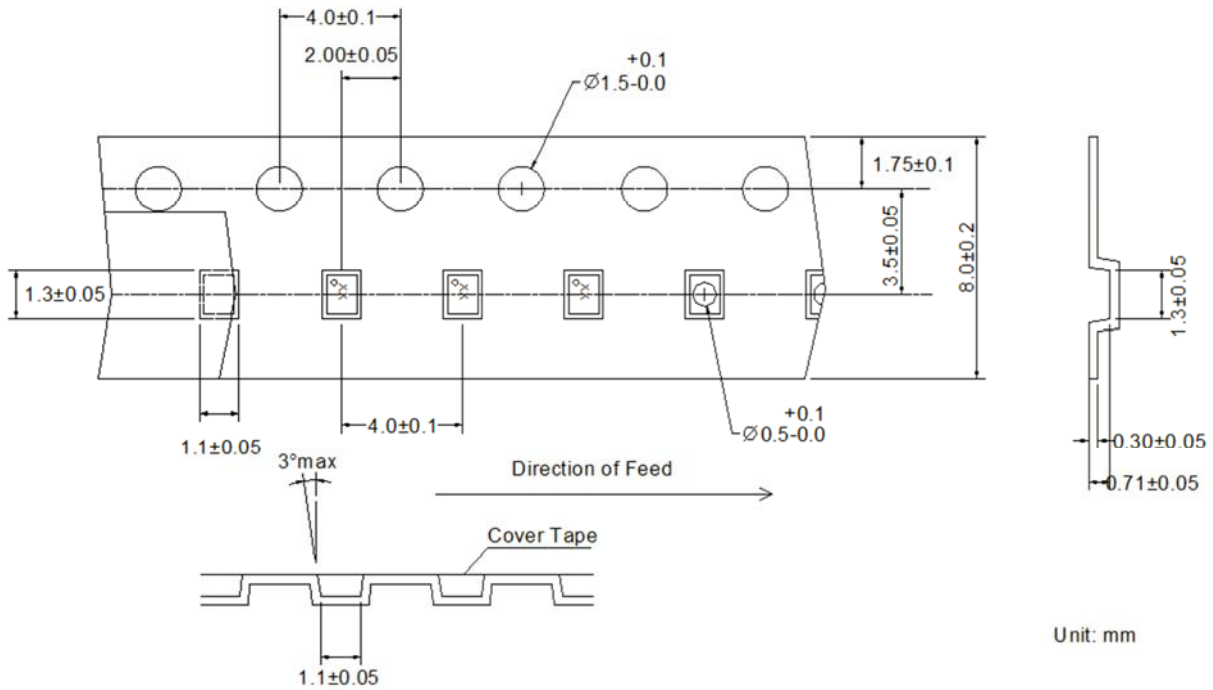

### 2. Reel Dimension

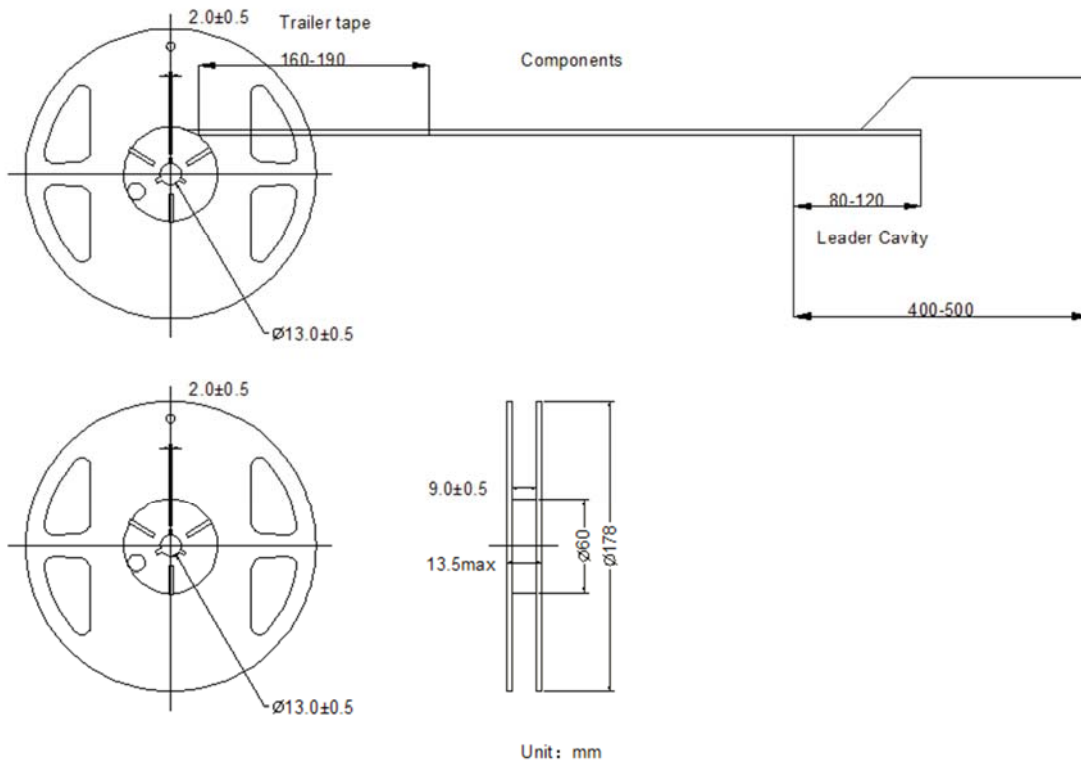

5000Pcs/Reel



## Recommended IR Reflow Profile

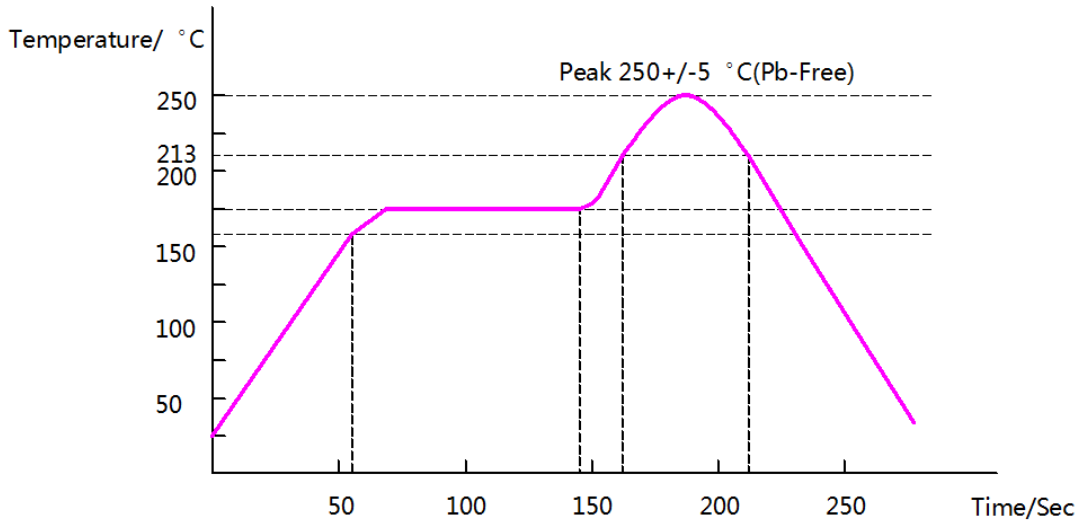

## Order Information

Part Number	Qty Per Reel	Container
YTLP2416E	5000	7 inch Reel



## X-ON Electronics

Largest Supplier of Electrical and Electronic Components

*Click to view similar products for [Signal Conditioning category](#):*

*Click to view products by [YTL manufacturer](#):*

Other Similar products are found below :

[MAPDCC0001](#) [MAPDCC0004](#) [PD0409J5050S2HF](#) [HHS-109-PIN](#) [AFS14A30-2185.00-T3](#) [AFS14A35-1591.50-T3](#) [DS-323-PIN](#) [DSS-313-PIN](#) [B39321R801H210](#) [1A0220-3](#) [JP510S](#) [LFB212G45SG8C341](#) [LFB322G45SN1A504](#) [LFL182G45TC3B746](#) [SF2159E](#) [30057](#)  
[AFS1575.42S4-T](#) [FM-104-PIN](#) [CER0813B](#) [MAPDCC0005](#) [3A325](#) [40287](#) [41180](#) [ATB3225-75032NCT](#) [BD0810N50100AHF](#) [JHS-115-PIN](#)  
[DC0710J5005AHF](#) [DC2327J5005AHF](#) [43020](#) [LFB2H2G60BB1C106](#) [LFL15869MTC1B787](#) [X3C19F1-20S](#) [XC3500P-20S](#) [10013-20](#)  
[SF2194E](#) [CDBLB455KCAX39-B0](#) [TGL2208-SM, EVAL](#) [RF1353C](#) [051157-0000](#) [PD0922J5050D2HF](#) [1E1305-3](#) [1F1304-3S](#) [1G1304-30](#)  
[B0922J7575AHF](#) [10017-3](#) [TP-103-PIN](#) [BD1222J50200AHF](#) [BD1722J50100AHF](#) [2450DP39K5400E](#) [BD0810J50150AHF](#)