

RoHS

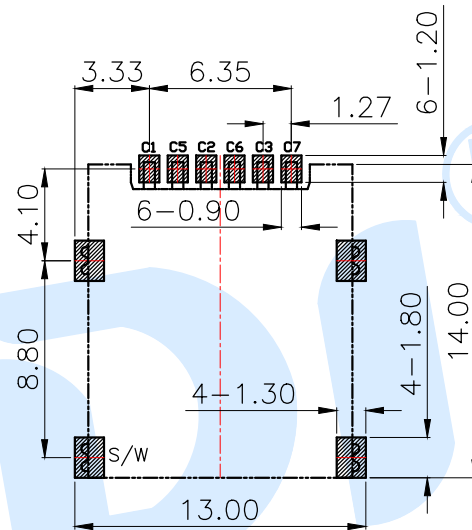

RECOMMENDED PCB LAYOUT  
 GENERAL TOLERANCE ±0.05  
 SMT SOLDER AREA

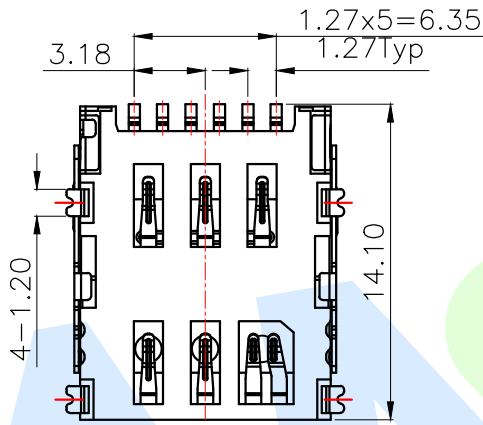
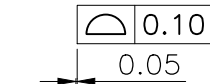
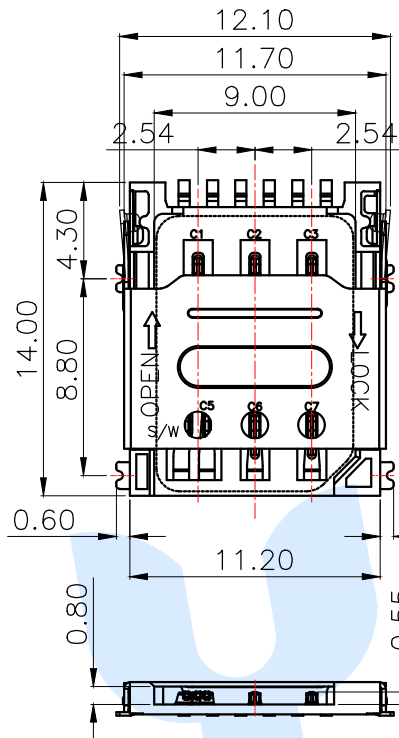
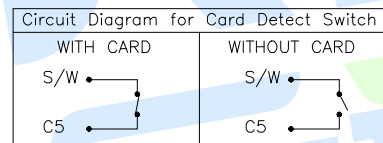

- Specifications/技术规格:
- 1.Current rating/额定电流: 1.0A
  - 2.Voltage rating/额定电压: 50V DC
  - 3.Insulation Resistance/绝缘电阻: 100MΩ Min
  - 4.Dielectric Withstanding/耐电压: 500V AC/minute
  - 5.Contact Resistance/接触电阻: 100mΩ Max
  - 6.Durability/耐久性: 5,000 Insertions
  - 7.Operating Temperature/工作温度: -25°C to +85°C

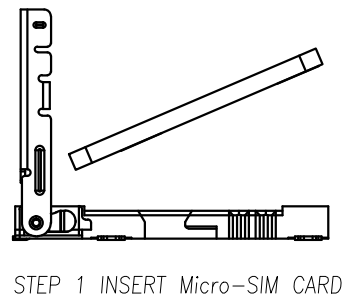
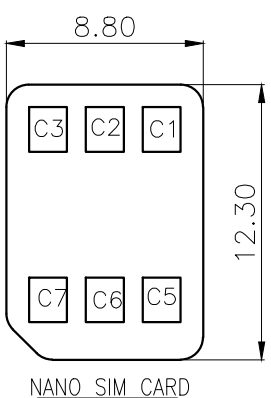

| SIM CARD |            |
|----------|------------|
| Pin No.  | NAME       |
| C1       | VCC        |
| C2       | RST        |
| C3       | CLK        |
| C5       | GND        |
| C6       | VPP        |
| C7       | I/O        |
| S/W      | SWITCH Pin |

| NO. | Name     | Number | Qty | Materil         | Remarks    |
|-----|----------|--------|-----|-----------------|------------|
| Ⓓ   | Terminal | 6      |     | Phosphor bronze | Au plated  |
| Ⓒ   | Contact  | 7      |     | Phosphor bronze | Au plated  |
| Ⓑ   | Cover    | 1      |     | SUS             | Ni Plating |
| Ⓐ   | Base     | 1      |     | LCP             | Black      |

YUANDI® Yuandi Electronics Co., Ltd

|          |      |       |                         |
|----------|------|-------|-------------------------|
| design   | date | name  | NANO SIM CARD CONNECTOR |
| Review   | date | model | NANO-SIM-502A           |
| Approved | date |       |                         |

## X-ON Electronics

Largest Supplier of Electrical and Electronic Components

*Click to view similar products for [Memory Card Connectors](#) category:*

*Click to view products by [Yuandi](#) manufacturer:*

Other Similar products are found below :

[6407-249V-25273P](#) [6407-249V-25343P](#) [6426-201-21343](#) [69.920.0553.0](#) [MCR60A-98D-2.54DSA\(70\)](#) [809180410000000](#) [DM3AT-SF-PEJM5\(41\)](#) [IC11S-BUR-PNEJL\(71\)](#) [C70210M0083692](#) [252-0144-000](#) [2041353-2](#) [308-DS1P0811-192](#) [HM2P09PDR360N9LF](#) [10014744-011TLF](#) [11327-001](#) [11327-002](#) [NX1-32T-KT3K\(05\)](#) [95622-003LF](#) [84648-056HLF](#) [CCM03-3109 B LFT](#) [MS3116J10-6PW](#) [2309923-1](#) [61126-050CAHLF](#) [GTFP08432B1HR](#) [G85D1160022HHR](#) [SCE2MSDB76A121SN](#) [SCE2MSDZN76A121SN](#) [10014744-011ALF](#) [10014744-011LF](#) [10057542-1211FLF](#) [10067972-000LF](#) [10067972-050LF](#) [10122302-20110LF](#) [G85D1162022HHR](#) [TF-05A](#) [M6014-12](#) [XKNANO-1412](#) [SMN-304-ARP6](#) [MIS11-S1F1-2000-A](#) [SMN-308-ARSP7](#) [SMN-308-ACSP7](#) [K-DYX-008](#) [K-DYX-004](#) [HYCW126-TF18-150B](#) [C7024-03](#) [SMO-1030](#) [MCS-110-KT](#) [SIM-217](#) [SNO-1355-KT](#) [SMO-1025-P10](#)