

RoHS

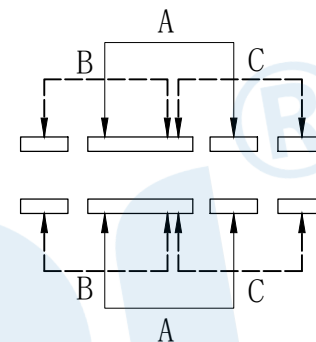

PCB Layout(Pattern side)

Circuit Diagram

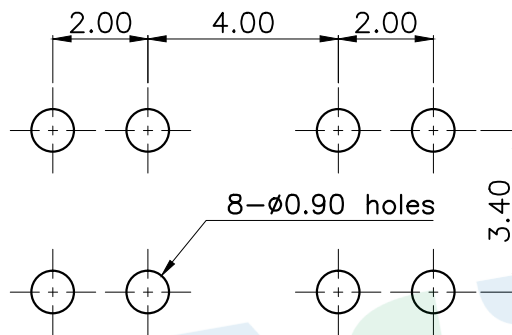
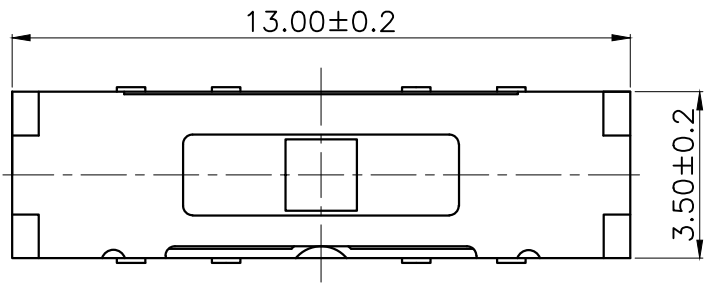
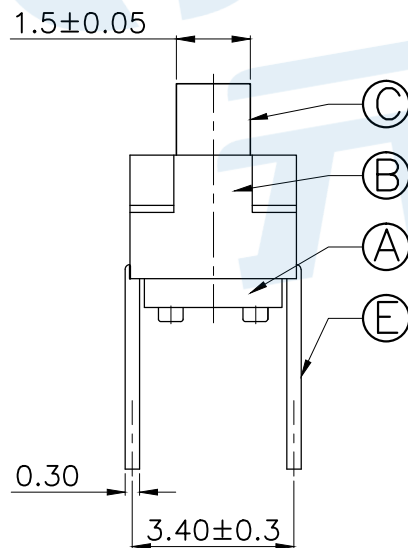
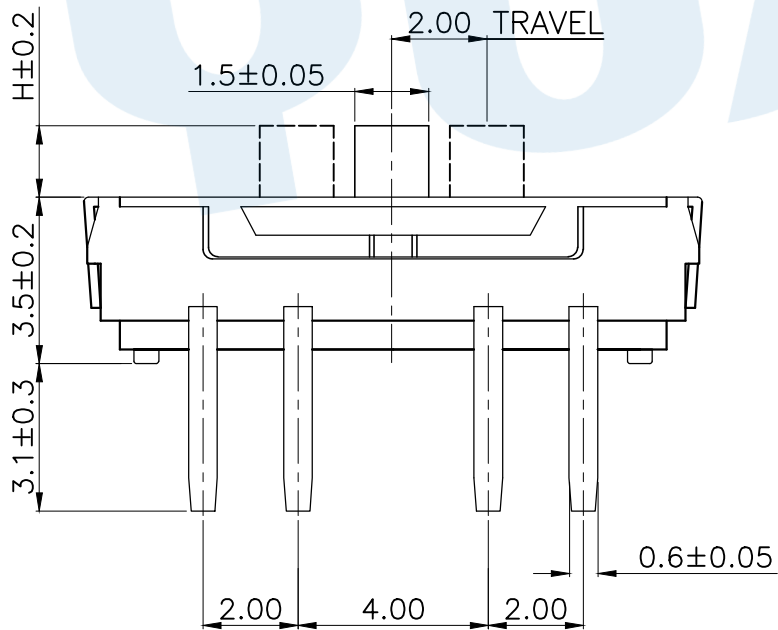

Code	H	Operating force
A1	2.0	250±100gf
A2	3.0	
A3	4.0	

NO.	Name	Number	Qty	Materil	Remarks
⑤	Terminal		8	Brass	Silver
④	Contact reed		2	Beryllium copper	Silver covered
③	Handle		1	PA46	Black
②	Cover		1	SUS	Silver
①	Base		1	PA46	Black

YUANDI® Yuandi Electronics Co, Ltd

design	date	name	TOGGLE SWITCH
Review	date	name	TA-3532-A□
Approved	date	name	

Drawing number: Proportion 1:1 unit mm gage number A4

modify Review Approved Tolerance not specified

angle	±2'
10~30	±0.30
5~10	±0.20
~ 5	±0.10

X-ON Electronics

Largest Supplier of Electrical and Electronic Components

Click to view similar products for [Toggle Switches](#) category:

Click to view products by [Yuandi](#) manufacturer:

Other Similar products are found below :

[A19HV](#) [8A1-C-222](#) [60012L](#) [6006L](#) [6663](#) [7101MD9V30GE](#) [7101SPDV30BE](#) [7103SDV30BE](#) [7105D](#) [7108P3YAV2BE](#) [71YY50282](#)
[7201MD9AVBE](#) [7301K38](#) [7306K36](#) [7310K36](#) [7314K36](#) [7506K4](#) [7592K6](#) [7691K14](#) [7700K1](#) [8396K108](#) [8824K14](#) [8828K13](#) [G2VX](#) [G3VX](#)
[PS83-121G](#) [A101MD9AB04](#) [A101SD9AB04](#) [A101SDCQ04](#) [A103SD9AQ04](#) [A107TZB04](#) [A123P32YZQ](#) [A123S1YZG](#) [A127S1YCQ](#) [1-](#)
[1825192-0](#) [A131S1YZQ](#) [A201SCWZB04](#) [A207SYCB04](#) [A208J61ZQ0004](#) [A221K12KAG](#) [A221S1YZQ](#) [A221T1TCQ](#) [A232K12KZQ](#)
[A232M1YCQ](#) [A323S1CWZQ](#) [A423S1CWZG-M8](#) [A423S1YZQ](#) [12149A-3V](#) [12156AX408](#) [12147AGKX679](#)