

RoHS

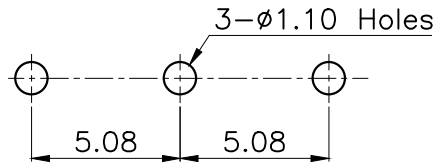

PCB Layout (Pattern side)

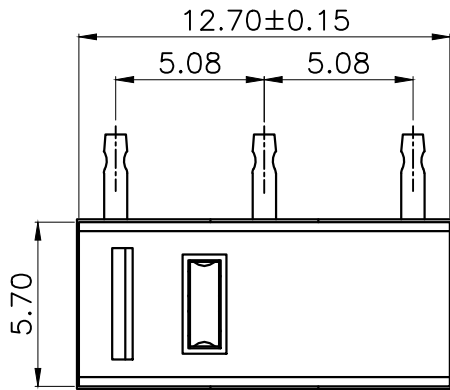
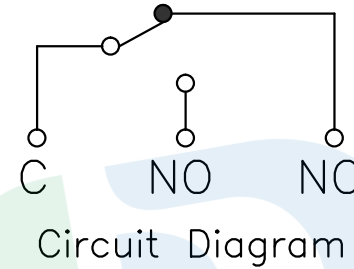

Circuit Diagram

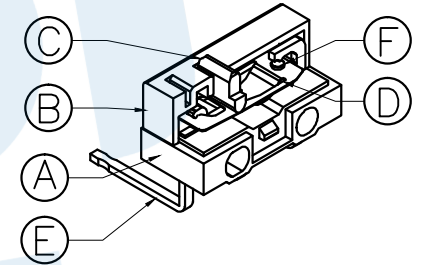
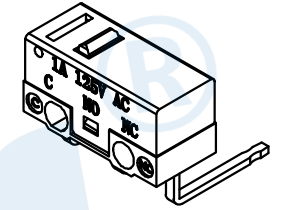

Operating force
80±15gf

Contact material	
CODE	MATERIAL
T	Copper dot
Y	Silver dot

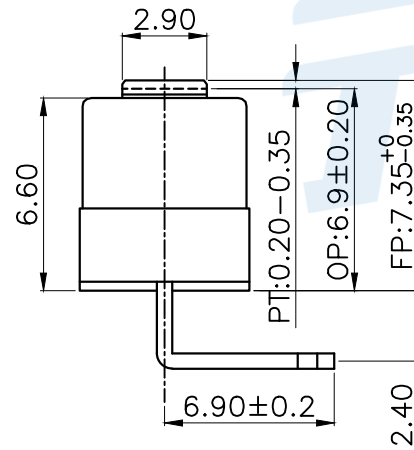
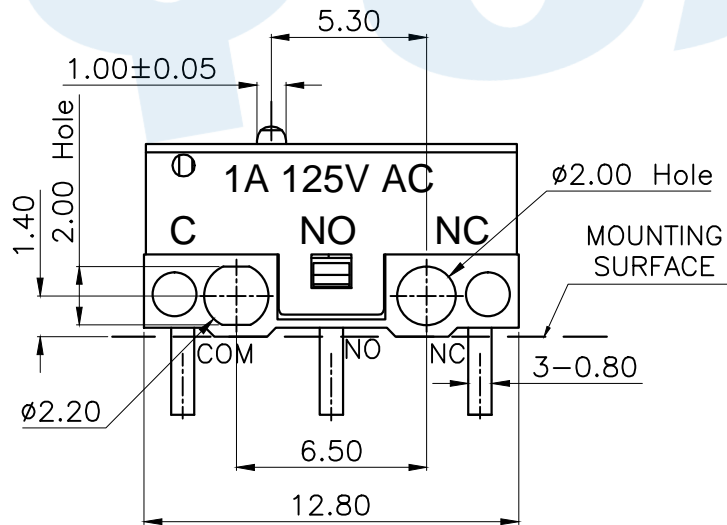

ⓕ	Contact	1	Silver/copper dot		
ⓔ	Terminal	3	Brass	Silver	
ⓓ	Contact reed	1	Brass		
Ⓒ	Handle	1	POM	White	
Ⓑ	Cover	1	PBT	Black	
Ⓐ	Base	1	PBT	White	
NO.	Name	Number	Qty	Material	Remarks

YUANDI® Yuandi Electronics Co., Ltd

design	date	name	MICRO SWITCH
Review	date	name	TC-5610A8-□
Approved	date	name	

Drawing number: Proportion 1:1 unit mm gage number A4

modify Review Approved Tolerance not specified

angle	±2'
10~30	±0.30
5~10	±0.20
~ 5	±0.10

X-ON Electronics

Largest Supplier of Electrical and Electronic Components

Click to view similar products for [Basic / Snap Action Switches](#) category:

Click to view products by [Yuandi](#) manufacturer:

Other Similar products are found below :

[83228001](#) [01.098.1358.1](#) [602EN1-6B](#) [602EN532](#) [602EN535-RB](#) [602HE5-RB1](#) [604HE162](#) [604HE223-6B](#) [624HE17-RB](#) [6HM89](#) [6PA78-JM](#)
[6SE1](#) [6SX1-H58](#) [70500840](#) [MBD5B1](#) [MBH2731](#) [73-316-0012](#) [79211759](#) [79211923](#) [79218589](#) [7AS12](#) [ML-1155](#) [ML-1376](#) [831010C3.0](#)
[831060C3.TL](#) [831090C2.EL](#) [83131904](#) [84212012](#) [8AS239](#) [8HM73-3](#) [903VB1-PG](#) [914CE1-6G](#) [PL-100](#) [11SM1077-H4](#) [11SM1077-H58](#)
[11SM1-TN107](#) [11SM405](#) [11SM703-T](#) [11SM8423-H2](#) [11SX37-T](#) [11SX48-H58](#) [11SX55-H58](#) [11SM2442-T](#) [11SM76-T](#) [11SM77-H58](#)
[11SM77-T](#) [11SM863-T](#) [11SM866](#) [11SX47-H58](#) [A7CN-1M-1-LEFT](#)