

RoHS

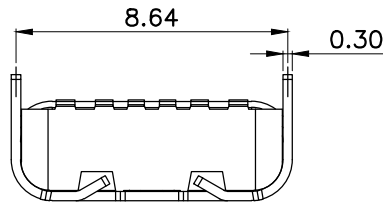

PIN ASSIGNMENTS

A5	CC1	B12	GND
A9	VBUS	B9	VBUS
A12	GND	B5	CC2
PIN	SIGNAL NAME	PIN	SIGNAL NAME

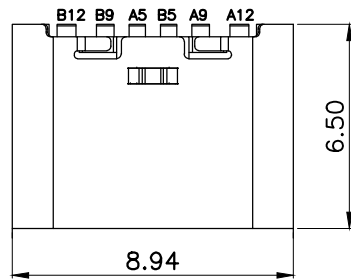
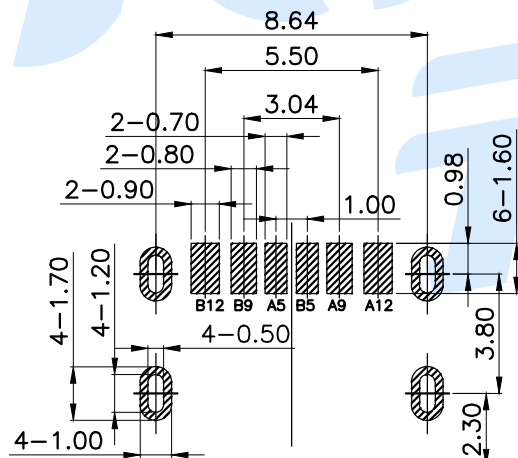
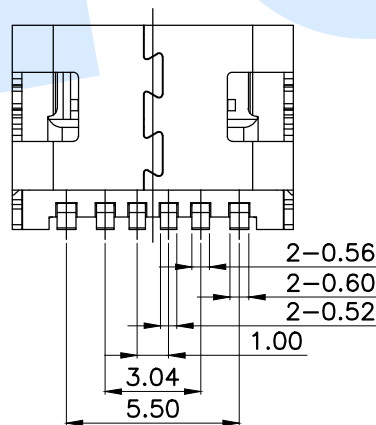
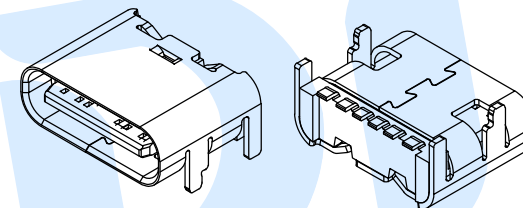
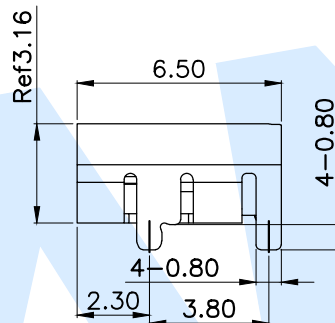
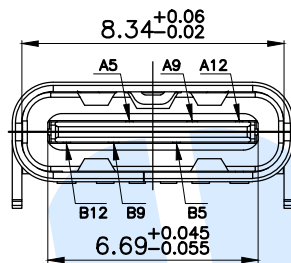

- SPECIFICATION,
  - 1-1.INSERTION FORCE: 0.5~2.0kgf.
  - 1-2.REMOVAL FORCE: 0.8kgf~2.0kgf.
  - 1-3.DURABILITY: 10000 CYCLES.
- ELECTRICAL PERFORMANCE,
  - 2-1. CURRENT RATING:5.0A  
VOLTAGE RATING:20V
  - 2-2. LLCR:  
VBUS & GND PINS AND OTHER PINS: 40mΩ/PIN MAX.  
SHIELD: 50mΩ/MAX.  
LLCR MAX. CHANGE OF ALL PINS: 10mΩ.
  - 4-3.INSULATION RESISTANCE: 100MΩ MIN
  - 4-4.DIELECTRIC WITHSTAND VOLTAGE,AC 100V FOR 1 MINUTE.
- ENVIRONMENTAL PERFORMANCE:  
OPERATING TEMPERATURE: -30°C~+80°C.
- IR REFLOW:  
THE PEAK TEMPERATURE ON THE BOARD SHALL BE MAINTAINED FOR 10 SECONDS AT 260°C.

RECOMMEND P.C.B LAYOUT (COMPONENT SIDE)  
TOLERANCE FOR PCB LAYOUT IS ± 0.05

Ⓒ	Terminal		6	Phosphor bronze	Au Plating
Ⓑ	Shell		1	Stainless Steel	Ni Plating
Ⓐ	Base		1	LCP	Black
NO.	Name	Number	Qty	Material	Remarks

YUANDI® Yuandi Electronics Co., Ltd

design	date	name	USB CONNECTOR
Review	date	model	TYPE-603-6.5-T3-5A
Approved	date		

Drawing number: Proportion 1:1 unit mm gage number A4

modify Review Approved Tolerance not specified

angle	±2'
10~30	±0.30
5~10	±0.20
~ 5	±0.10

RoHS

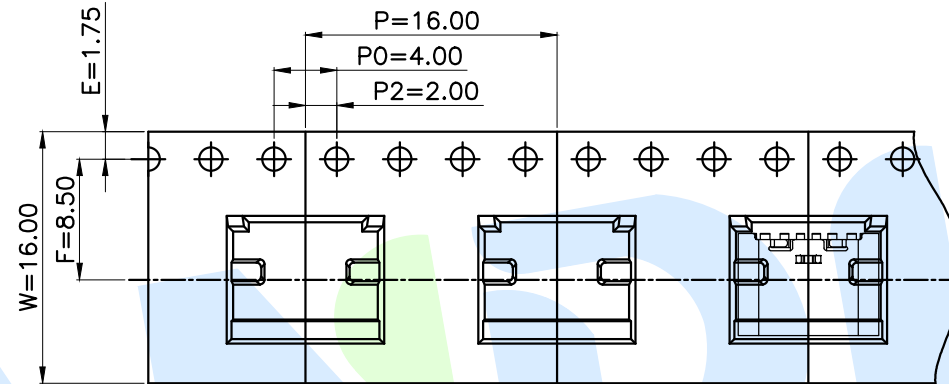
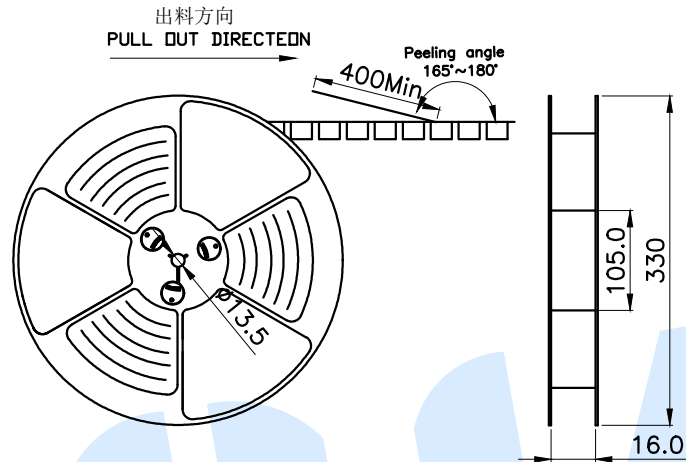

NOTES

1. 帶子引導長度  
LEAD TAPE LENGTH  
出料方向  
PULL OUT DIRECTION

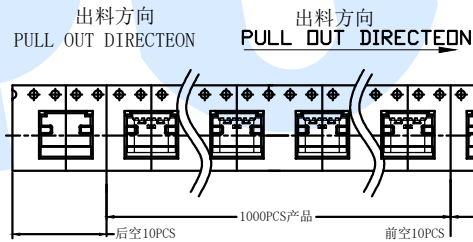

2. 上帶 剝力力為: 0.1~1.3N(10.2gf~130gf)  
PEELING OFF FORCE OF TOP TAPE:0.1~1.3N(10.2gf~130gf)  
出貨' 運輸過程中一定注意:  
THIS REQUIREMENT SHOULD BE APPLIED AT SHIPMENT:  
卷帶在運輸過程中不能散開  
PEELING OFF SHOULD NOT BE ALLOWED DURING TRANSPORTATION

1 REEL= 1000 PCS

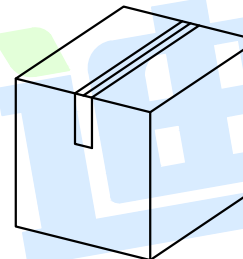
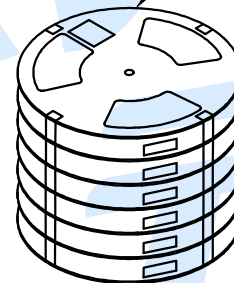

YUANDI® Yuandi Electronics Co, Ltd  
元迪

design	date	name	USB CONNECTOR
Review	date	model	TYPE-603-6.5-T3-5A
Approved	date		

Drawing number: Proportion 1:1 unit mm gage number A4

modify Review Approved Tolerance not specified

## X-ON Electronics

Largest Supplier of Electrical and Electronic Components

*Click to view similar products for [USB Connectors](#) category:*

*Click to view products by [Yuandi](#) manufacturer:*

Other Similar products are found below :

[950](#) [A-USB A-LP-SMT-C](#) [A-USB B-TOP-C](#) [MUSBD11135](#) [17-200721](#) [217450-1](#) [KMBVX-TH-5S-B30](#) [KUSBX-AS2N-W](#) [KUSBX-SMT2AP1S-W30](#) [935](#) [957](#) [30-498-6](#) [SK-60A-2](#) [1734082-1](#) [30-470](#) [30-489](#) [30-541](#) [MAB 5 S](#) [A-USB A-2P-C](#) [MIKROE-1451](#)  
[USBFTVSCCG](#) [1-1734084-2](#) [MUSBA81130](#) [NK-27-32SL](#) [NK-L8-22C-5/8](#) [10135326-001LF](#) [4198](#) [690-024-633-031](#) [UB-20PMFP-LC7001](#)  
[17-200011](#) [UB-20AFMM-LL7A01](#) [CAP-WCCMLPB1](#) [CAP-WCCMLPC1](#) [2274475-3](#) [914-614A2025S10200](#) [USB3FTV7SAGF059](#)  
[USB3FTV2SAZNF459](#) [USB3FTV7SAZNF459](#) [U221-041N-1WVS62-F5D](#) [HYCW153-USBD05-500B](#) [HYCW219-USBD05-075B](#)  
[HYCW148-USBD05-117B](#) [HYCW149-USBD05-740B](#) [HYCW204-USBD05-108B](#) [HYCW214-USBA04-113B](#) [HYCW213-USBA04-113B](#)  
[KMMX-BSMT35S-1-B30TR](#) [2345986-1](#) [10082141-N340LF](#) [10117836-011LF](#)