

RoHS

PIN ASSIGNMENTS

A5	CC1	B12	GND
A9	VBUS	B9	VBUS
A12	GND	B5	CC2
PIN	SIGNAL NAME	PIN	SIGNAL NAME

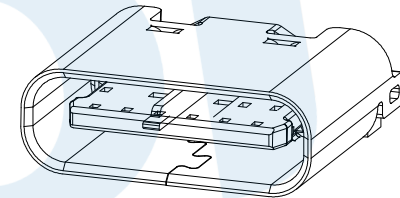
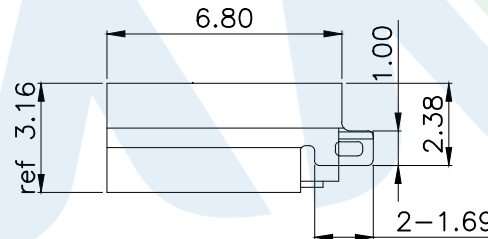
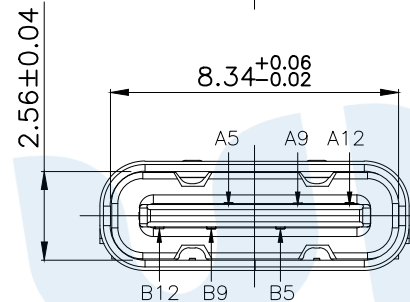
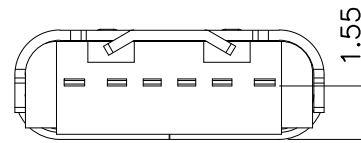
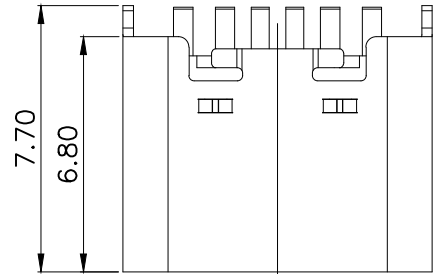

- SPECIFICATION,
  - INSERTION FORCE: 0.5~2.0kgf.
  - REMOVAL FORCE: 0.8kgf~2.0kgf.
  - DURABILITY: 10000 CYCLES.
- ELECTRICAL PERFORMANCE,
  - CURRENT RATING:3.0A  
VOLTAGE RATING:5.0V
  - LLCR:
    - VBUS & GND PINS AND OTHER PINS: 40mΩ/PIN MAX.
    - SHIELD: 50mΩ/MAX.
    - LLCR MAX. CHANGE OF ALL PINS: 10mΩ.
  - INSULATION RESISTANCE: 100MΩ MIN
  - DIELECTRIC WITHSTAND VOLTAGE,AC 100V FOR 1 MINUTE.
- ENVIRONMENTAL PERFORMANCE:
  - OPERATING TEMPERATURE: -25°C~+85°C.
- IR REFLOW:
  - THE PEAK TEMPERATURE ON THE BOARD SHALL BE MAINTAINED FOR 10 SECONDS AT 260°C.

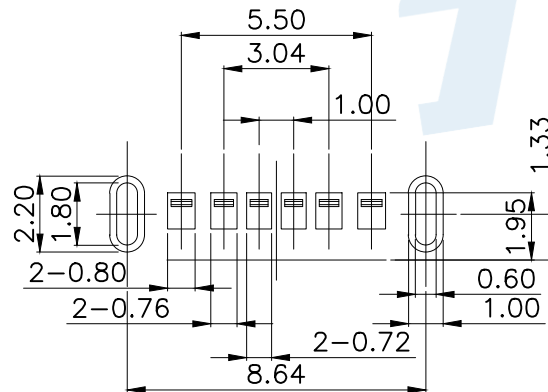
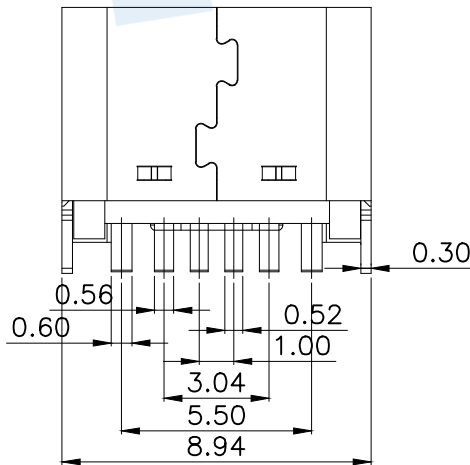

Recommended P.C.B Layout

◎	Terminal		6	Phosphor bronze	Au Plating
Ⓑ	Shee		1	Stainless Steel	Ni Plating
Ⓐ	Base		1	LCP	Black
NO.	Name	Number	Qty	Materil	Remarks

**YUANDI**® Yuandi Electronics Co, Ltd

design	date	name	USB CONNECTOR
Review	date	model	TYPE-604-T3
Approved	date		

Drawing number: Proportion 1:1 unit mm gage number A4

modify Review Approved Tolerance not specified

angle	±2'
10~30	±0.30
5~10	±0.20
~ 5	±0.10

## X-ON Electronics

Largest Supplier of Electrical and Electronic Components

*Click to view similar products for [USB Connectors](#) category:*

*Click to view products by [Yuandi](#) manufacturer:*

Other Similar products are found below :

[950](#) [A-USB A-LP-SMT-C](#) [A-USB B-TOP-C](#) [MUSBA511N5](#) [MUSBC111M5](#) [MUSBD11135](#) [17-200721](#) [217450-1](#) [KMBVX-TH-5S-B30](#)  
[896-30-004-00-000000](#) [KUSBX-AS2N-W](#) [KUSBX-SMT2AP1S-W30](#) [935](#) [957](#) [30-498-6](#) [SK-60A-2](#) [1734082-1](#) [30-1574](#) [30-470](#) [30-489](#) [30-](#)  
[541](#) [30-572-3](#) [A-USB A-2P-C](#) [MIKROE-1451](#) [USBFTV2PEM2G](#) [USBFTVSCCG](#) [4689-1](#) [1-1734084-2](#) [MUSBC11135](#) [USBF21ZNSCC](#)  
[USBBFTV6ZC](#) [MUSBB151341](#) [10135326-001LF](#) [M9177/3-1](#) [TJ-105](#) [USB-A-S-F-B-VT](#) [4198](#) [690-024-633-031](#) [UB-20PMFP-LC7001](#)  
[USBFTVC6MRG](#) [UA-20BMFA-SL8001](#) [17-200011](#) [USBFTVC7ZC](#) [UB-20AFMM-LL7A01](#) [USBFTVC2MN](#) [CAP-WCCMLPB1](#) [1310-](#)  
[1031-01](#) [2041386-1](#) [2274475-3](#) [UB-20BMFA-SL8001](#)