

RoHS

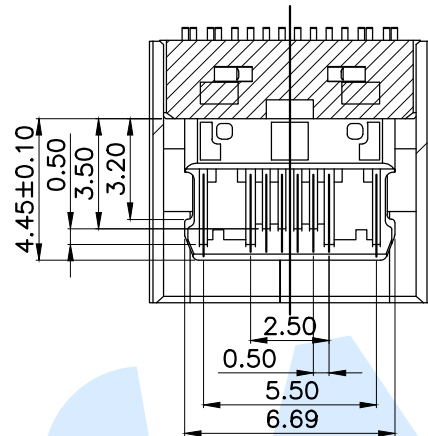

SECTION B-B  
SCALE 1:1

A1	GND	B12	GND
A4	VBUS	B9	VBUS
A5	CC1	B8	SBU2
A6	DP1	B7	DN2
A7	DN1	B6	DP2
A8	SBU1	B5	CC2
A9	VBUS	B4	VBUS
A12	GND	B1	GND
PIN	SIGNAL NAME	PIN	SIGNAL NAME

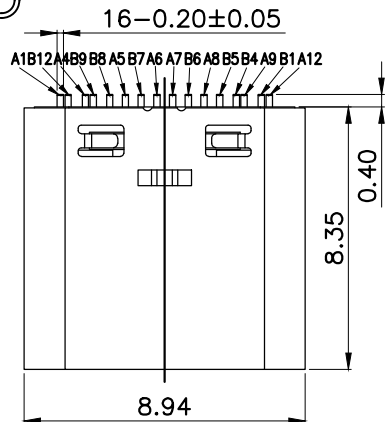
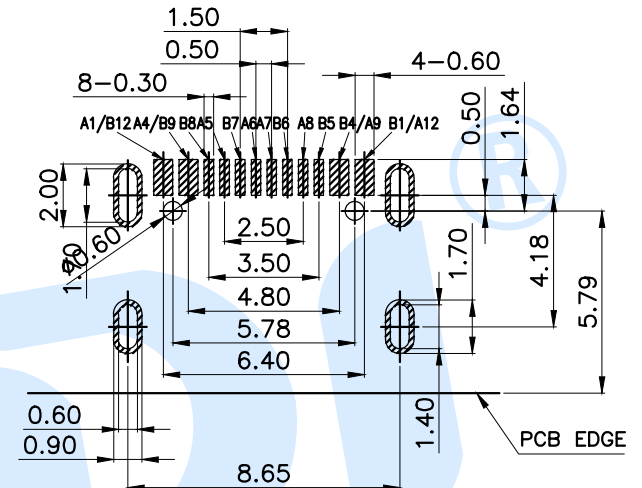

RECOMMEND P.C.B LAYOUT (COMPONENT SIDE)  
TOLERANCE FOR PCB LAYOUT IS ± 0.05

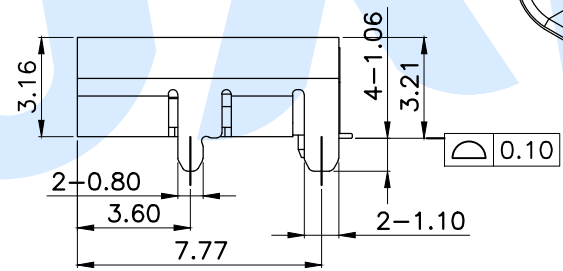
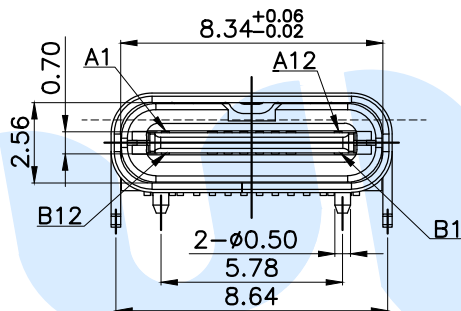
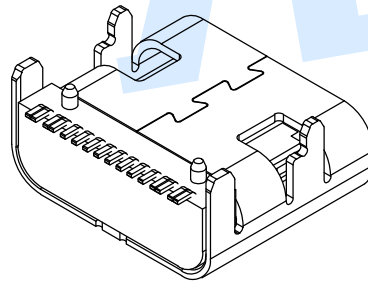
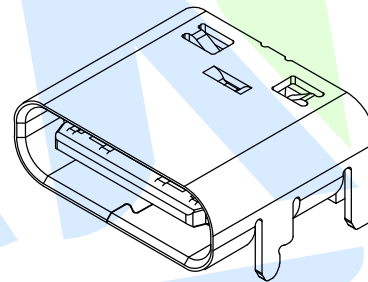

SECTION A-A  
SCALE 1:1

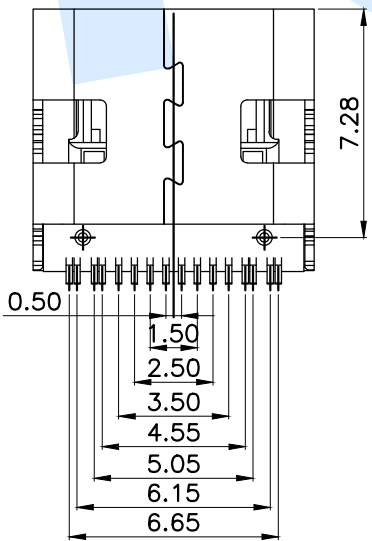
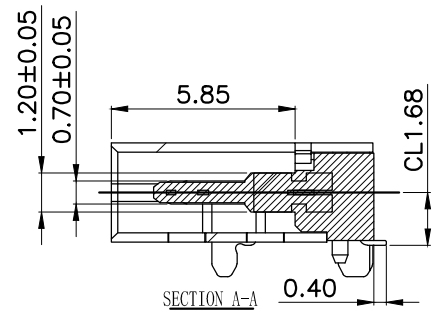

- SPECIFICATION,
  - 1-1. INSERTION FORCE: 0.5~2.0kgf.
  - 1-2. REMOVAL FORCE: 0.8kgf~2.0kgf.
  - 1-3. DURABILITY: 10000 CYCLES.
- ELECTRICAL PERFORMANCE,
  - 2-1. CURRENT RATING: 5.0A  
VOLTAGE RATING: 20V
  - 2-2. LLCR:  
VBUS & GND PINS AND OTHER PINS: 40mΩ/PIN MAX.  
SHIELD: 50mΩ/MAX.  
LLCR MAX. CHANGE OF ALL PINS: 10mΩ.
  - 2-3. INSULATION RESISTANCE: 100MΩ MIN
  - 2-4. DIELECTRIC WITHSTAND VOLTAGE, AC 100V FOR 1 MINUTE.
- ENVIRONMENTAL PERFORMANCE:  
OPERATING TEMPERATURE: -30°C~+80°C.
- IR REFLOW:  
THE PEAK TEMPERATURE ON THE BOARD SHALL BE MAINTAINED FOR 10 SECONDS AT 260°C.

◎	Terminal		16	Phosphor bronze	Au Plating
ⓑ	Shell		1	Stainless Steel	Ni Plating
Ⓐ	Base		1	LCP	Black
NO.	Name	Number	Qty	Material	Remarks

YUANDI® Yuandi Electronics Co, Ltd

design	date	name	USB CONNECTOR
Review	date	model	TYPE-611-8.35-T3-5A
Approved	date		

Drawing number: Proportion 1:1 unit mm gage number A4

angle	±2'
10~30	±0.30
5~10	±0.20
~ 5	±0.10

modify Review Approved Tolerance not specified

RoHS

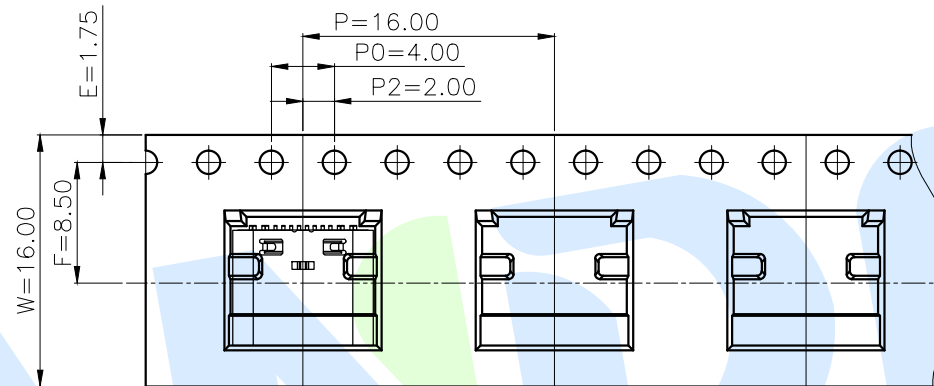
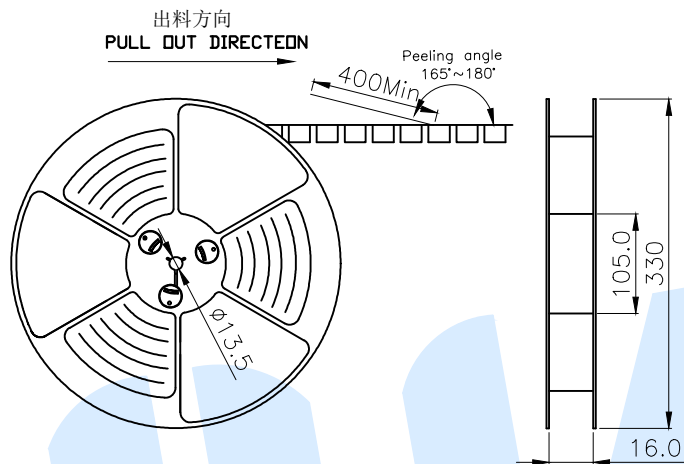

NOTES

1. 帶子引導長度  
LEAD TAPE LENGTH

出料方向  
PULL OUT DIRECTEON

出料方向  
PULL OUT DIRECTEON

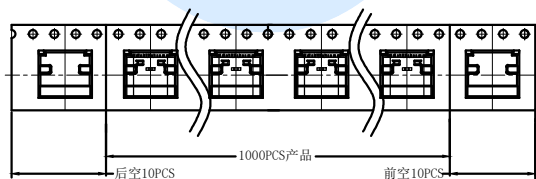

2. 上帶 剝力力為: 0.1~1.3N (10.2gf~130gf)  
PEELING OFF FORCE OF TOP TAPE: 0.1~1.3N (10.2gf~130gf)

出貨'運輸過程中一定注意:  
THIS REQUIREMENT SHOULD BE APPLIED AT SHIPMENT:  
卷帶在運輸過程中不能散開  
PEELING OFF SHOULD NOT BE ALLOWED DURING TRANSPORTATION

1 REEL= 1000 PCS

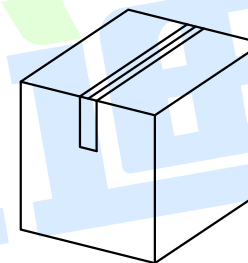
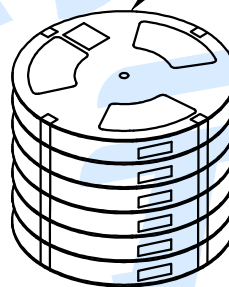

YUANDI® Yuandi Electronics Co, Ltd

design	date	name	USB CONNECTOR
Review	date	model	TYPE-611-8.35-T3-5A
Approved	date		

Drawing number: Proportion 1:1 unit mm gage number A4

modify Review Approved Tolerance not specified

## X-ON Electronics

Largest Supplier of Electrical and Electronic Components

*Click to view similar products for [USB Connectors](#) category:*

*Click to view products by [Yuandi](#) manufacturer:*

Other Similar products are found below :

[950](#) [A-USB A-LP-SMT-C](#) [A-USB B-TOP-C](#) [MUSBD11135](#) [17-200721](#) [217450-1](#) [KMBVX-TH-5S-B30](#) [KUSBX-AS2N-W](#) [KUSBX-SMT2AP1S-W30](#) [935](#) [957](#) [30-498-6](#) [SK-60A-2](#) [1734082-1](#) [30-470](#) [30-489](#) [30-541](#) [MAB 5 S](#) [A-USB A-2P-C](#) [MIKROE-1451](#)  
[USBFTVSCCG](#) [1-1734084-2](#) [MUSBA81130](#) [NK-27-32SL](#) [NK-L8-22C-5/8](#) [10135326-001LF](#) [4198](#) [690-024-633-031](#) [UB-20PMFP-LC7001](#)  
[17-200011](#) [UB-20AFMM-LL7A01](#) [CAP-WCCMLPB1](#) [CAP-WCCMLPC1](#) [2274475-3](#) [914-614A2025S10200](#) [USB3FTV7SAGF059](#)  
[USB3FTV2SAZNF459](#) [USB3FTV7SAZNF459](#) [U221-041N-1WVS62-F5D](#) [HYCW153-USBD05-500B](#) [HYCW219-USBD05-075B](#)  
[HYCW148-USBD05-117B](#) [HYCW149-USBD05-740B](#) [HYCW204-USBD05-108B](#) [HYCW214-USBA04-113B](#) [HYCW213-USBA04-113B](#)  
[KMMX-BSMT35S-1-B30TR](#) [2345986-1](#) [10082141-N340LF](#) [10117836-011LF](#)