

DESCRIPTION

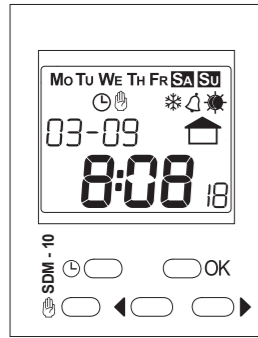

Displayed items and messages description

Mo Tu We Th Fr Sa Su - week's days

☰ - automatic mode

☷ - manual mode

* - winter time

☀ - summer time

🔔 - bell ringing

🏠 - School year active

bAnk 1, bAnk2 - setting banks

StARt - lessons beginning

LESS - lesson duration

bELL - bell ringing duration

PAUSE - break duration

ALERT - alarm mode

dAY - day

YEAR - year

Auto - automatic

USEr - user's

On OFF - ON / OFF

Button description

- ☰ • the main window – the automatic mode enter or, if the auto mode is already ON, switch-OFF;
- ☷ • the other windows – exit to a higher level without data entered saving;

- ☷ • the main window - the manual mode enter or, if the manual mode is already ON, switch-OFF;
- ☷ • the other windows – exit to a higher level without data entered saving;

- OK • the main window – the main menu enter;
- ☷ • the other windows – a submenu enter or the set value acknowledgement;

- ◀▶ • window / option toggle or the set value increase / decrease.

MAIN MENU

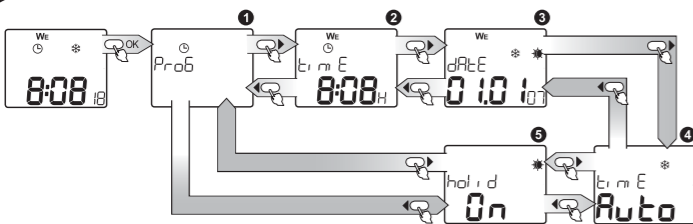

Menu enter by pressing OK;
menu items scrolling be means of the cursors ◀▶.

Function	Description
1 PrOb	LESSON, BREAK AND BELL RINGING DURATION SETTING
2 t, m, E	CURRENT TIME SETTING
3 dAtE	CURRENT DATE SETTING
4 t, m, E	WINTER / SUMMER TIME SETTING
5 hol, d	HOLIDAY BREAK SETTING

DATE SETTING

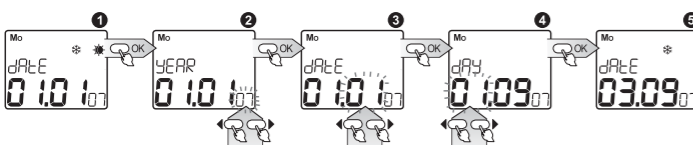

- dAtE - the current date setting ; enter by pressing OK;
- RYEAR - with ◀▶ cursors select a year and acknowledge with OK; allowable settings: 2000+2099;
- MONTH - with ◀▶ cursors select a month and acknowledge with OK;
- DAY - with ◀▶ cursors select the month's day and acknowledge with OK; the unit is protected against entering incorrect days for the given month (leap years accounted) and calculates the week's day on the basis of the set date;
- After acknowledgement the date setting window is open and current winter/summer time is set, if the auto option is active RuTo.

It is possible to exit any submenu window at any moment without settings saving by pressing ☰ or ☷ key.

TIME SETTING AND WINTER / SUMMER TIME TOGGLING

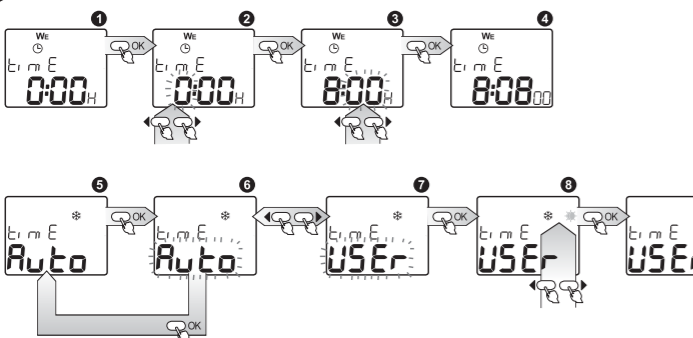

- t, m, E - current time setting; enter by pressing OK;
- HOUR - with ◀▶ select hour in one of the following formats: 1-24 H, 1-12 A (AM), 1-12 P (PM), acknowledge by pressing OK;
- MINUTES - with ◀▶ cursors select minutes and acknowledge by pressing OK;
- Minutes acknowledgement causes seconds reset and entering the time setting window;
- t, m, E - winter / summer time toggle mode selection: Auto - automatic time changing on the last March Sunday, at 2:00, into summer time and on the last October Sunday, at 3:00 into winter time USEr - winter / summer time toggle manual; enter by pressing OK;
- MODE SETTING - with ◀▶ select Auto or USEr and press OK; after selecting Auto, winter / summer time will be toggled automatically in dependence of the current time and date; after USEr mode selecting you enter the next window;
- With ◀▶ select winter / summer, where: * is winter time, ☀ is summer time; if the time icon is changed, the timer will correct the current time appropriately; acknowledge selection by pressing OK;
- After the time mode selecting winter / summer time toggle window will be open.

It is possible to exit any submenu to a higher level, at any moment without settings saving by means of pressing ☰ or ☷ key.

LESSON, BREAK AND BELL RINGING DURATION SETTING

- PrOb - setting: lesson beginning time, lesson duration, successive breaks duration and the bell ringing duration; enter the mode by pressing OK;
- With ◀▶ select the settings bank for all time settings; it is possible to select one of the banks: bAnk 1 or bAnk2, where it is possible to set various times (e.g. bAnk 1 - std lessons, bAnk2 - short lessons); the default active one is bAnk 1; switching to the bank bAnk2 is realized by means of IN2 control input; in order to enter settings edition for the given bank press OK;

- 1, 2, 3 - windows for time settings; the windows toggling by means of the cursors ◀▶;

Window 1 - StARt - lesson beginning hour and lesson days setting (these days the bell will be operating in the auto mode): press OK to enter; 2 with ◀▶ set the lesson beginning hour; acknowledge with OK; 3 with ◀▶ set the lesson beginning minute and press OK; 4 with ◀▶ select lesson days (for the automatic mode setting for the bell); there are three week division modes available: Monday - Friday, Saturday and Sunday, all week; after acknowledgement with OK the lesson duration setting win 5 will be open;

Window 4 - LESS - lesson duration setting in minutes: press OK to enter; 5 with ◀▶ select lesson duration in minutes; after acknowledgement by pressing OK the bell ringing duration setting window will be open 6;

Window 6 - bELL - bell ringing duration setting in seconds: press OK to enter; 6 with ◀▶ cursors select bell ringing duration in seconds; after selection acknowledgement by pressing OK the break duration setting window will be 7 open;

Window 7 - PAUSE - the break duration viewing and setting in minutes: press OK to enter; 8 with ◀▶ cursors select the break to set and press OK; 9 with ◀▶ select the break duration within the range between 0 and 60 minutes; acknowledge with OK; 10, 11 with ◀▶ cursors select successive break no. to set; maximum number of the breaks is 20 12; enter edition by pressing OK; the marker E... is designed for the last break marking - the ringing program will be running until the first marker E... near the break no. is met (further programmed breaks will not be realized).

It is possible to exit any submenu to a higher level at any moment, without settings saving, by means of pressing the keys ☰ or ☷.

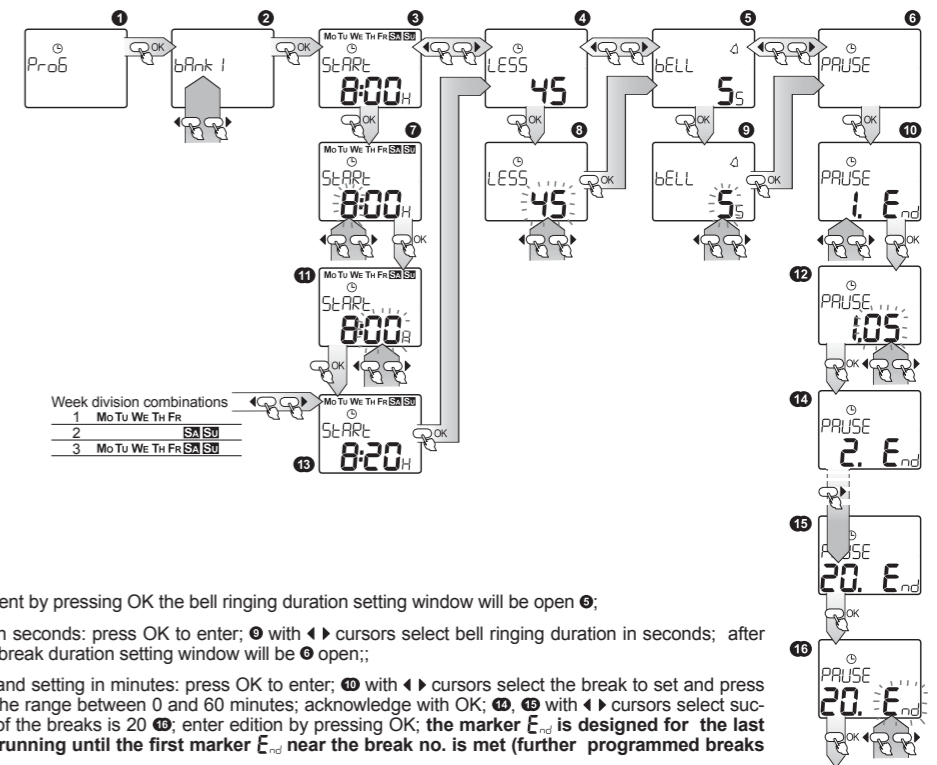

HOLIDAY BREAK SETTING

- hol, d - holiday break setting; enter the mode by pressing OK;
- With ◀▶ set activity On or inactivity OFF for the holiday break; acknowledge by pressing OK;
- Selecting OFF causes the holiday break settings main window 4;
- With ◀▶ cursors select the beginning day StARt or the ending day StOP for the holiday break; press OK;

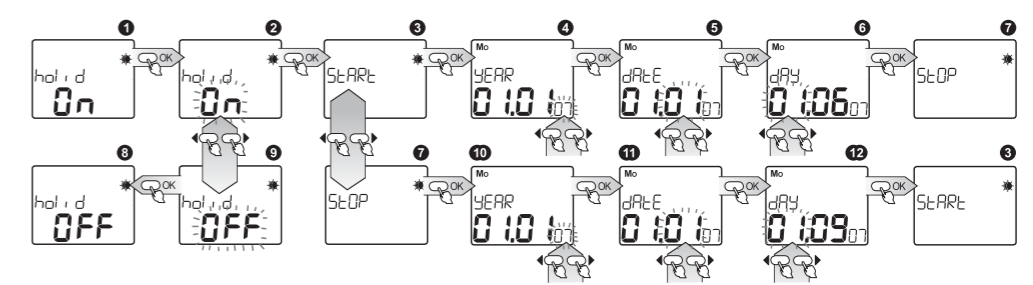

- With ◀▶ cursors select an appropriate year; acknowledge selection by pressing OK;
- With ◀▶ cursors select a month; acknowledge selection by pressing OK;
- With ◀▶ cursors select the month's day; acknowledge selection by pressing OK;
- After the settings acknowledgement the holiday break ending setting window StOP will be open;
- 10, 11, 12 In the same way as for the holiday break beginning day set the year, month and day; After the setting acknowledgement the holiday break beginning setting window will be open StARt.

It is possible to exit any submenu to a higher level at any moment, without settings saving, by means of pressing the key ☰ or ☷.

OPERATING MODE CHANGE (AUTOMATIC, MANUAL, OFF)

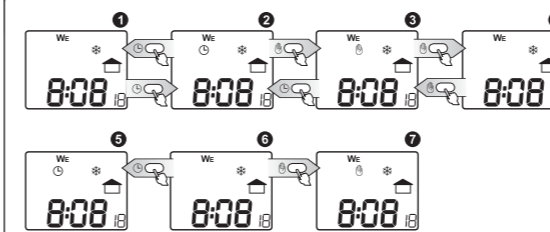

The manual op mode change (the bell manual switching ON / OFF) - if the main window is open and the automatic mode is set 2 pressing the key ☷ will cause entering the manual mode 3; successive key ☷ pressing will cause changeover between 3 & 4 the manual mode and the OFF mode..

The automatic mode change (system operating according to the previous settings) - if the main window is open and the manual mode is set 3 pressing the key ☷ will cause entering the automatic mode 2; successive key ☷ pressing will cause changeover between the OFF and auto mode (4 & 2).

Exit from the OFF mode (the relay is OFF permanently) - if the main window is open and the OFF mode is set, 5 pressing the key ☷ will cause entering the manual mode 3, pressing the key ☷ will cause entering the automatic mode 2.

SDM-10, SDM-10/U SCHOOL BELL CONTROLLER

INSTRUCTION MANUAL



**Zakład Mechaniki i Elektroniki
ZAMEL sp.j.**
J.W. Dzida, K. Łodzińska



ul. Zielona 27, 43-200 Pszczyna, Poland
Tel. +48 (32) 210 46 65, Fax +48 (32) 210 80 04
www.zamelcet.com, e-mail: marketing@zamel.pl

ASSEMBLY

1. Disconnect the electric network by means of an appropriate cut-off, current-limiting circuit-breaker or separator.
2. Check if there is no any voltage between power leads by means of an appropriate gauge.
3. Mount the **SDM-10** controller on TH 35 rail.
4. Connect the system leads to the terminals according to the electrical diagram.
5. Connect power supply circuit.

CONNECTIONS

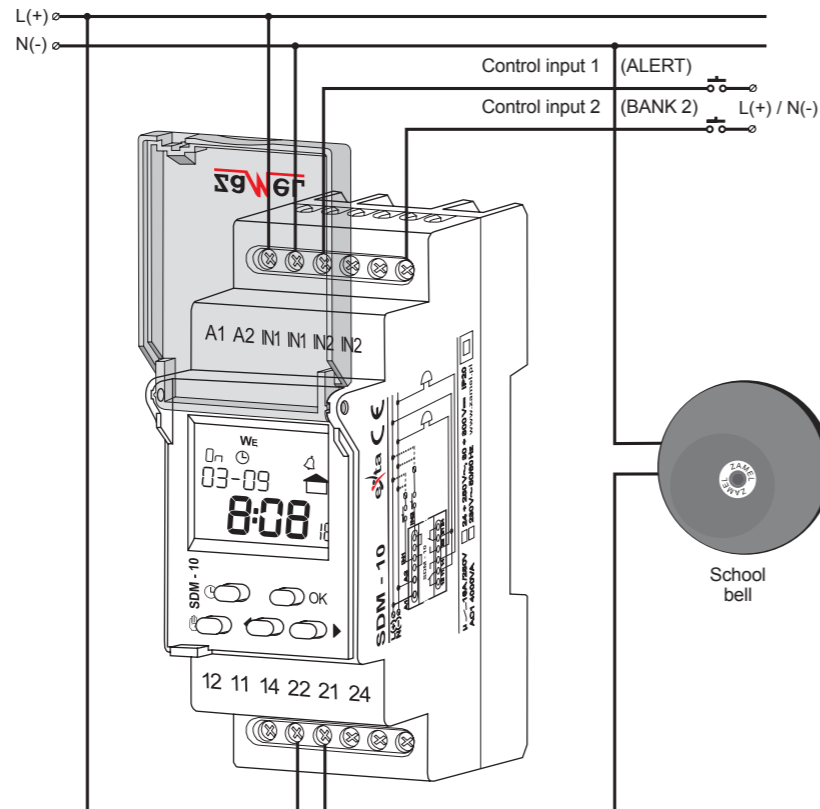

UNIT DIAGRAM

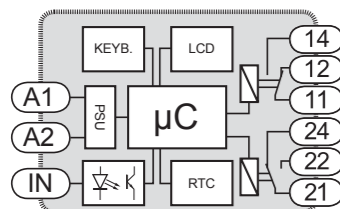

CASING DIMENSIONS

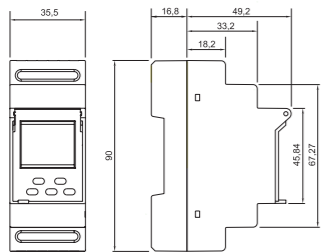

PRODUCT FAMILY

The SDM-10 controller is a member of the SDM product family.

SDM - xx/U

Power supply: SDM-10: 230 V~ SDM-10/U: 24 + 250 V~ 30 + 300 V~
Device version: 10 - basic
Device type

DEVICE CONTROL

There are two independent control inputs:

- **Control input 1 (alert)** – after L or N signal comes on the input terminal the manual op mode is set at once and two output relays are ON, and the display shows the message **ALERT**. After setting the input triggering OFF, the relays will be OFF, but the unit will remain in the manual mode for about 1 minute, and then will enter the op mode set before ALERT input operating.
- **Control input 2 (bank 2)** – after L or N signal comes on the input terminal the display shows **bank 2** and the bank 2 is set active – the settings declared for **bank 2** in the auto mode (e.g. short lessons) are binding. After setting the input triggering OFF settings programmed for **bank 1** will be restored (e.g. standard lessons).

MAIN RESET

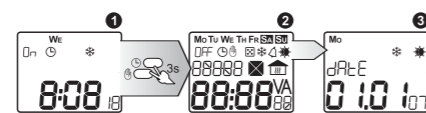

1. In order to cancel the timer settings time, date, data function activity, etc.) It is necessary, in the main window, to press and hold simultaneously (OK + i) for 3 seconds;
2. All the display fields will be illuminated;
3. After a while the timer will enter the date and time setting mode.

NOTE: In order to cancel all the saved programs it is necessary to hold **OK** key additionally.

WARRANTY

The product warranty is for a period of 24 months

1. ZMIE ZAMEL SP. J. assures 24 months guarantee for the product.
2. The manufacturer's guarantee does not cover any of the following actions:
 - a) mechanical damage during transport, loading / unloading or under other circumstances,
 - b) damage caused by incorrect product mounting or misuse,
 - c) damage caused by unauthorised modifications made by the PURCHASER or any third parties to the product or any other devices needed for the product functioning,
 - d) damage caused by Act of God or any other incidents independent of the manufacturer.
3. The PURCHASER shall lay any claims in writing to the dealer or ZMIE ZAMEL SP. J.
4. ZMIE ZAMEL SP. J. is liable for processing any claim according to current Polish legislation.
5. ZMIE ZAMEL SP. J. shall process the claim at its own discretion: product repair, replacement or money return.
6. The manufacturer's guarantee is valid in the Republic of Poland.
7. The PURCHASER's statutory rights in any applicable legislation whether against the retailer arising from the purchase contract or otherwise are not affected by this warranty.

Dealer signature & stamp, purchase date

DESCRIPTION

The SDM-10 school bell controller is designed for acoustic signalling control at schools using the school bells (e.g. DNT-212, DNS-212, DNT-212M, DNS-212M). The system control runs in an automatic mode according to the preset program. Program setting is operated by means of selecting the lesson duration, breaks duration and defining the beginning hour. The system is ready to implement some special functions (alert bells, short lessons) by means of programmable control inputs. The controller may be manufactured as a kit for assembling, EW-01 Electronic School Bell. **In case of power supply malfunction the unit battery sustain enables all settings saving and maintaining.**

FEATURES

- Easy time table programming algorithm,
- Easy lesson time changeover: normal / short,
- RTC circuit and built-in calendar,
- Bell ringing duration setting possible,
- Alert bells programming possible
- 2 control inputs for running programmed functions,
- Two power supply versions: 230 V or 24 + 250 V, 30 + 300 V
- Relay output — two changeover contacts, maximum load 16 A,
- Clock and program data battery sustain,
- LCD display LED illumination.



The device should be connected to a single-phase system according to current standards. The device connections will be described in this manual. Only qualified electricians are allowed to mount, connect and adjust the controller. It is necessary to read this manual before the device mounting. Do not disassembly the device casing or you will lose any warranty rights and expose yourself to the electric shock hazard. Before mounting operation make sure of disconnecting the connection wires from the electric network. Use a cross-head screwdriver of 3.5 mm diameter to mount the device. The controller should be carried, stored and used in an appropriate way. Do not mount the device in case of any unit parts lack, damage or deformation. In case of malfunction please notify the manufacturer.

TECHNICAL DATA

SDM - 10	
Power terminals:	A1, A2
Rated voltage:	SDM-10: 230 V~ (-15 + +10 %) SDM-10/U: 24 + 250 V~, 30 + 300 V~
Rated frequency:	50 / 60 Hz
Rated current:	2 W / 14 VA
Channels quantity:	1
Program:	manual cycle bell control
Operating modes:	manual, automatic
Summer / winter time changing:	automatic, manual
LCD panel illumination colour:	amber
External input:	yes
Time measure accuracy:	max. ±1 s / 24 h przy temp. 25 °C
Clock sustain time:	3 years
Program sustain time:	10 years
Trigger terminals:	IN1, IN2, INZ1, INZ2
Relay output terminals:	11, 12, 14, 21, 22, 24
Relay contacts parameters:	2 NO/NC-16 A/250 V AC1 4000 VA
Connection terminals quantity:	12
Connection wire section:	0,2 + 2,50 mm ²
Operating temperature:	-20 + +60 °C
Operating position:	optional
Casing fastening:	TH 35 rail (according to PN-EN 60715)
Casing IP:	IP20 (PN-EN 60529)
Protection class:	II
Overvoltage category:	II
Pollution level:	2
Dimensions:	double-module (35 mm) 90x5x66 mm
Weight:	140 g
Standard conformity:	PN-EN 60730-1; PN-EN 60730-2-1; PN-EN 61000-4-2,3,4,5,6,11

APPEARANCE

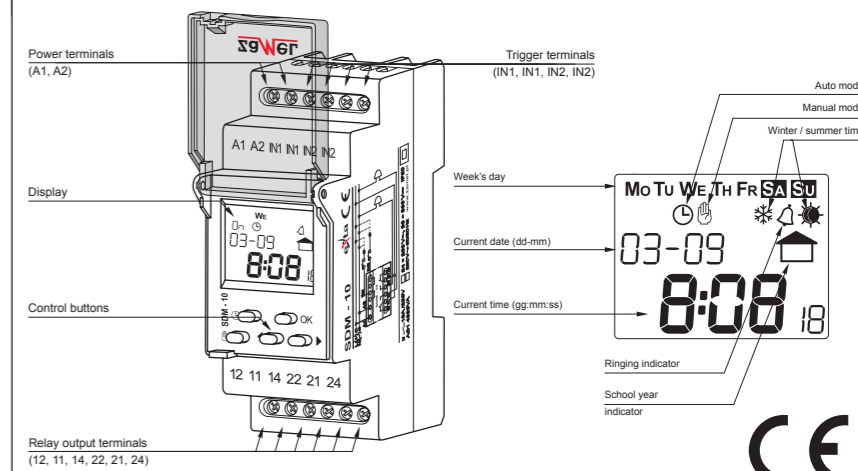

X-ON Electronics

Largest Supplier of Electrical and Electronic Components

Click to view similar products for [Timers](#) category:

Click to view products by [Zamel](#) manufacturer:

Other Similar products are found below :

[79237785](#) [H3DS-GL AC24-230/DC24-48](#) [H5AN-4DM DC12-24](#) [H5CN-XDNM AC100-240](#) [H5CN-YAN AC100-240](#) [H5CX-L8S-N AC100-240](#) [H3AMNSCAC100240](#) [H3AM-NSR-B AC100-240](#) [H3CA-8 DC12](#) [H3CR-A8-302 DC24](#) [H3CR-F AC24-48/DC12-48](#) [H3CR-G8EL AC200-240](#) [H5AN-4D DC12-24](#) [81506944](#) [88225029](#) [H5S-YB4-X](#) [H3CR-A-301 AC100-240/DC100-125](#) [H3CR-AS AC24-48/DC12-48](#) [H3DK-GE AC240-440](#) [H3RN-2 AC24](#) [H3RN-21 AC24](#) [H3CR-H8RL AC/DC24 M](#) [H3CR-H8RL AC100-120 S](#) [H3CR-G8EL-31 AC100-120](#) [H3CR-H8RL AC100-120 M](#) [H3CR-HRL AC100-120 M](#) [H3CR-A8-301 AC24-48/DC12-48](#) [H3CR-H8RL AC/DC24 S](#) [H7AN-2D DC12-24](#) [H5CN-XANS DC12-48](#) [H3CA-8 DC110](#) [H7AN-W4DM DC12-24](#) [H7AN-4DM DC12-24](#) [H7AN-4D DC12-24](#) [H7AN-RT6M AC100-240](#) [H3CA-8H AC200/220/240](#) [MTR17-BA-U240-116](#) [PM4HSDM-S-AC240VS](#) [PM4HSDM-S-AC240VSW](#) [PO-405](#) [600DT-CU](#) [H3Y-2-B DC24 30S](#) [PM4HF8-M-DC24V](#) [PM4HS-H-DC12VSW](#) [H3Y-2-B AC100-120 10S](#) [H3Y-2-B AC100-120 30S](#) [H3C-R](#) [H3CR-A8-301 24-48AC/12-48DC](#) [H3CR-A8E 24-48AC/DC](#) [H3CR-F8 100-240AC/100-125DC](#)