

# 零件承认书

## SPECIFICATION FOR APPROVAL

客户名称: \_\_\_\_\_

客户料号: \_\_\_\_\_

增益料号: **HI0603-4N3S**

规格描述: **陶瓷叠层电感 0201-4.3NH**

日期: **2020/12/3**

版本: **A**

### 增益签核:

制订	审核	核准
张翔	刘业明	柯文学

### 客户签核:

工程	审核	核准



**东莞市增益实业有限公司**

地址: 东莞市塘厦镇林村塘厦大道北552号  
 电话: 0769-87321000  
 传真: 0769-87891229

物料类型:	叠层电感
日期:	2020/12/3
版本:	A

# 图面规格变更履历表

客户		料号			品名	
客户版本	增益版本	变更内容	日期	制定	审核	核准
	A	初版	2020/12/3	张翔	刘业明	柯文学
<div style="display: flex; align-items: center;">  <div> <p style="margin: 0;"><b>东莞市增益实业有限公司</b></p> <p style="margin: 0;">地址：东莞市塘厦镇林村塘厦大道北552号</p> <p style="margin: 0;">电话：0769-87321000</p> <p style="margin: 0;">传真：0769-87891229</p> </div> </div>				物料类型：	叠层电感	
				日 期：	2020/12/3	
				版 本：	A	

# SPECIFICATION

## DIMENSION (Unit:mm) & SCHEMATIC

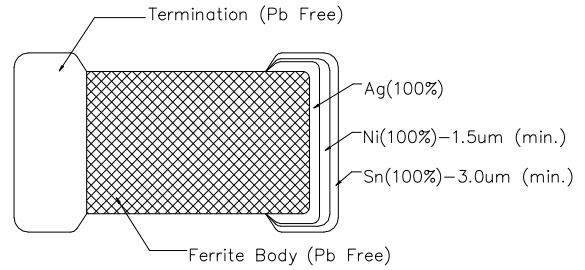
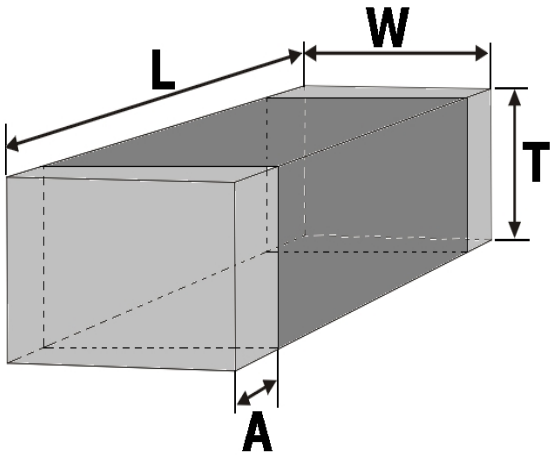

DIM	L	W	T	A				
MM	0.6	0.3	0.33	0.1-0.2				
SPEC	±0.03	±0.03	MAX	/				

## ELECTRICAL CHARACTERISTIC: TEMPERATURE AT 25°C

ITEM	L (nH)	DCR ( $\Omega$ )	I <sub>rms</sub> (mA)
SPEC	4.3±0.3nH	0.5 MAX	150 MAX
	HP4286A	502BC	VR116
100 MHz			



东莞市增益实业有限公司  
 地址：东莞市塘厦镇林村塘厦大道北552号  
 电话：0769-87321000  
 传真：0769-87891229

物料类型:

叠层电感

日期:

2020/12/3

版本:

A

制订

张翔

审核

刘业明

核准

柯文学

# 样品检测成绩表

客户名称:											
规格描述:		HI0603-4N3S									
交货数量	抽样数	抽样基准 MIL-STD-105E ■ 正常 检验标准 □ 加严 □ 减严	判定标准		测试环境		分项检查判定				
			主要	次要	温度	湿度	尺寸	外观	特性		
5PCS	5PCS		0.1	0.4	25°C	75%		OK		OK	OK
绝缘电阻DC	COIL TO CORE	V	COIL TO CORE	V	测试仪器 □ CH-9053 ■ HK-502BC						
		MΩ		MΩ	■ HP-4285 □ CH-100 ■ HY-7110						
耐电压AC		SEC		SEC	□ HP-4284 □ CH-1320 □ HK-310						
		KV		KV	□ TF-6815 □ HK-1062 ■ 卡尺						
测试条件	#REF!										
PIN	L(S-F)		DCR(S-F) AT 25°C (Ω)								
SPEC	4.3±0.3nH		0.5 MAX								
1	4.290		0.340								
2	4.310		0.370								
3	4.280		0.310								
4	4.270		0.380								
5	4.290		0.330								
6											
7											
8											
9											
10											
X											
R											
备注: TEPM: 20°C (REF)					RH: 60% (REF)						
 东莞市增益实业有限公司 地址: 东莞市塘厦镇林村塘厦大道北552号 电话: 0769-87321000 传真: 0769-87891229					物料类型:		叠层电感				
					日期:		2020/12/3				
					版本:		A				
制订	张翔		审核	刘业明		核准	柯文学				

# Reflow soldering conditions

- Pre - heating should be in such a way that the temperature difference between solder and ferrite surface is limited to 150°C max. Also cooling into solvent after soldering should be in such a way that the temperature difference is limited to 100°C max.

Unenough pre - heating may cause cracks on the ferrite, resulting in the deterioration of product quality.

- Products should be soldered within the following allowable range indicated by the slanted line. The excessive soldering conditions may cause the corrosion of the electrode, When soldering is repeated, allowable time is the accumulated time.

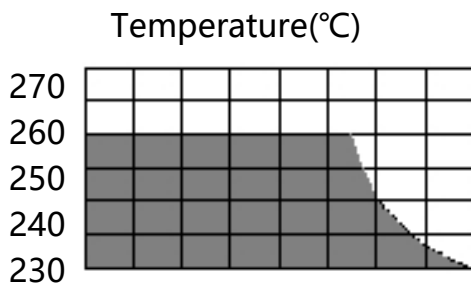

**Temperature Profile**

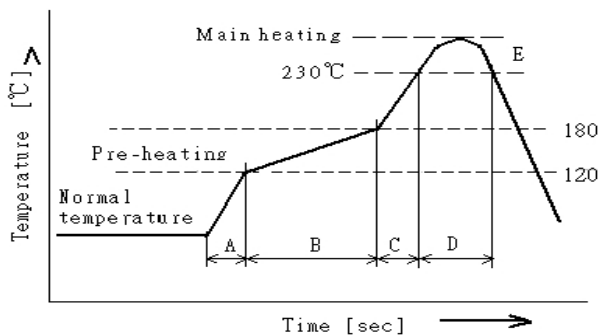

A	Slope of temp. rise	1 to 5	°C/sec
B	Heat time	50 to 150	sec
	Heat temperature	120 to 180	°C
C	Slope of temp. rise	1 to 5	°C/sec
D	Time over 230°C	90~120	sec
E	Peak temperature	255~260	°C
	Peak hold time	10 max.	sec
No. of mounting		3	times



东莞市增益实业有限公司  
 地址：东莞市塘厦镇林村塘厦大道北552号  
 电话：0769-87321000  
 传真：0769-87891229

物料类型:

叠层磁珠

日期:

2019/5/10

版本:

A

制订

张翔

审核

刘业明

核准

柯文学

# Reflow soldering conditions

## Reworking with soldering iron

Preheating	150°C, 1 minute
Tip temperature	280°C max
Soldering time	3seconds max.
Soldering iron output	30w max.
End of soldering iron	φ3mm max.

Reworking should be limited to only one time.

Note: Do not directly touch the products with the tip of the soldering iron in order to prevent the crack on the ferrite material due to the thermal shock.

## Solder Volume

Solder shall be used not to be exceed the upper limits as shown below.

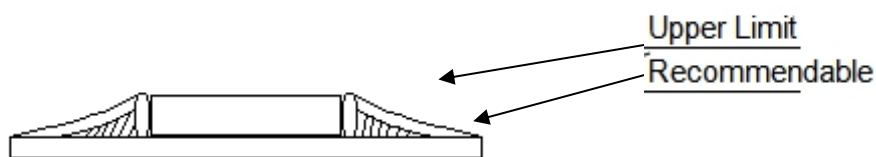

Accordingly increasing the solder volume, the mechanical stress to product is also increased. Exceeding solder volume may cause the failure of mechanical or electrical performance.



东莞市增益实业有限公司  
地址：东莞市塘厦镇林村塘厦大道北552号  
电话：0769-87321000  
传真：0769-87891229

物料类型:

叠层电感

日期:

2020/12/3

版本:

A

制订

张翔

审核

刘业明

核准

柯文学

# 包装方式数量图示

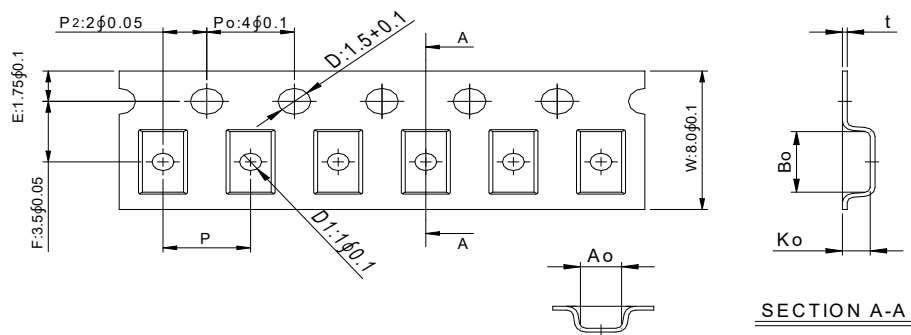
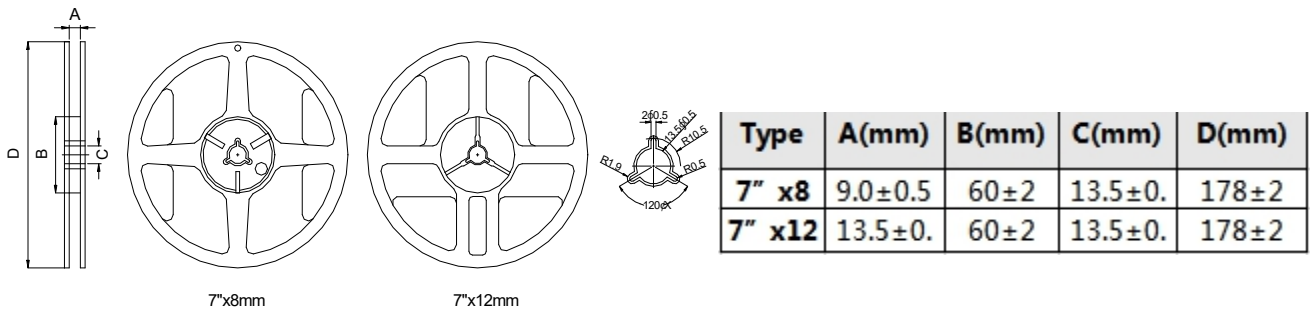

Series	Size	Bo(mm)	Ao(mm)	Ko(mm)	P(mm)	t(mm)	DI(mm)
HI	060305	0.72±0.05	0.4±0.05	0.45±0.05	2.0±0.1	0.23±0.05	none
FCB.FCM	100505	1.12±0.05	0.67±0.05	0.54±0.05	2.0±0.1	0.23±0.05	none
HCB.HPB	160808	1.80±0.10	1.01±0.10	1.02±0.10	4.0±0.1	0.22±0.05	none
HFB	201209	2.25±0.10	1.42±0.10	1.04±0.10	4.0±0.1	0.22±0.05	1.0±0.1
FCI	201212	2.35±0.10	1.50±0.10	1.45±0.10	4.0±0.1	0.22±0.05	1.0±0.1
FHL, FCH	321611	3.50±0.10	1.88±0.10	1.27±0.10	4.0±0.1	0.22±0.05	1.0±0.1
HCI	322513	3.42±0.10	2.77±0.10	1.55±0.10	4.0±0.1	0.22±0.05	1.0±0.1
FCA	321609	3.40±0.10	1.77±0.10	1.04±0.1	4.0±0.10	0.22±0.05	1.0±0.1

**包装数量：15000PCS/盘**



东莞市增益实业有限公司  
 地址：东莞市塘厦镇林村塘厦大道北552号  
 电话：0769-87321000  
 传真：0769-87891229

物料类型:

叠层电感

日期:

2020/12/3

版本:

A

制订

张翔

审核

刘业明

核准

柯文学

## X-ON Electronics

Largest Supplier of Electrical and Electronic Components

*Click to view similar products for [Fixed Inductors](#) category:*

*Click to view products by [Zeng Yi](#) manufacturer:*

Other Similar products are found below :

[CR32NP-151KC](#) [CR32NP-180KC](#) [CR32NP-181KC](#) [CR32NP-1R5MC](#) [CR32NP-390KC](#) [CR32NP-3R9MC](#) [CR32NP-680KC](#) [CR32NP-820KC](#) [CR32NP-8R2MC](#) [CR43NP-390KC](#) [CR43NP-560KC](#) [CR43NP-680KC](#) [CR54NP-181KC](#) [CR54NP-470LC](#) [CR54NP-820KC](#) [CR54NP-8R5MC](#) [70F224AI](#) [MGDQ4-00004-P](#) [MHL1ECTTP18NJ](#) [MHQ1005P10NJ](#) [MHQ1005P1N0S](#) [MHQ1005P2N4S](#) [MHQ1005P3N6S](#) [MHQ1005P5N1S](#) [MHQ1005P8N2J](#) [PE-51506NL](#) [PE-53601NL](#) [PE-53602NL](#) [PE-53630NL](#) [PE-53824SNLT](#) [PE-92100NL](#) [PG0434.801NLT](#) [PG0936.113NLT](#) [9220-20](#) [9310-16](#) [PM06-2N7](#) [PM06-39NJ](#) [A01TK](#) [1206CS-471XJ](#) [HC2LP-R47-R](#) [HC2-R47-R](#) [HC3-2R2-R](#) [HCF1305-3R3-R](#) [1206CS-151XG](#) [RCH664NP-140L](#) [RCH664NP-4R7M](#) [RCH8011NP-221L](#) [RCP1317NP-332L](#) [RCP1317NP-391L](#) [RCR1010NP-470M](#)