

SEALED TRANSFORMER, PCB 0.35VA EE20-6.5 SERIES

PAGE REV	DESCRIPTION	DATE	BY
A0	CREATED	2010-07-08	Jacise
A3	Modified	2012-11-13	ye
A4	Modified MECHANICAL SPECIFICATIONS	2015-10-26	ye

1. ELECTRICAL SPECIFICATIONS:

- A. Input Voltage and Frequency: 115/230V @ 50/60 Hz
- B. Secondary Voltage: See Electrical Table
- C. Ambient Temperature: 50°C MAX allowed.
- D. Insulation Resistance:
100M Ohm Min @ 500VDC PRI. to SEC.
- E. Hi-Pot:
4200Vrms 1 minute @ PRI. to SEC., when the primary input voltage is 230V
2800Vrms 1 minute @ PRI. to SEC., when the primary input voltage is 115V

F. APPROVALS:

UL 5085 class 2 and class 3 recognized, VDE EN 61558 recognized.
Conforms to EN 60950 .

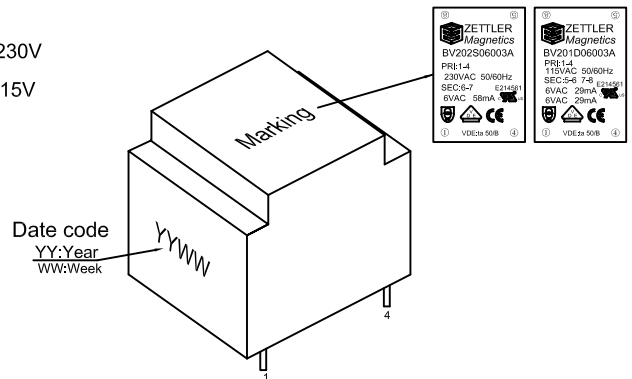

2. MECHANICAL SPECIFICATIONS:

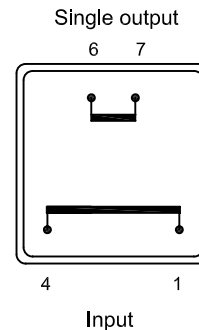
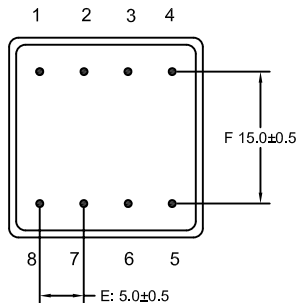
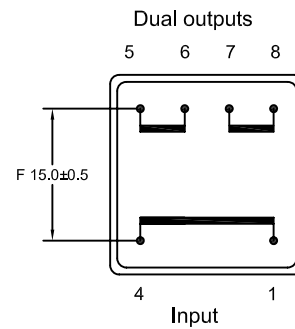
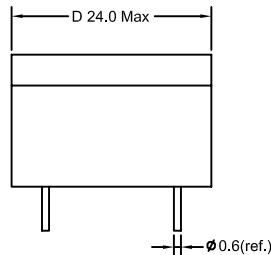
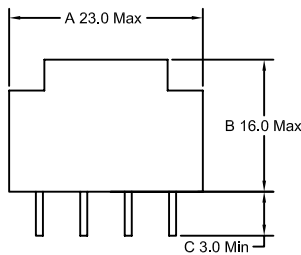

UNIT	TOLERANCE
MM	X.X = ±0.5
3RD ANGLE	X.XX = ±0.3
	ANG = -
SCALE:	DATA
DRAWN: ye	2015-10-26
CHECKED:	
APPROVED:	

ZETTLER MAGNETICS

TITLE: SEALED TRANSFORMER, PCB 0.35VA

PART NO: BV20XXXX003A

ZM Project:	SPEC REV: A/4
Customers p/n:	SH NO 1/3

Web: www.zettlermagnetics.com
E-mail: sales@zettlermagnetics.com

PAGE REV	DESCRIPTION	DATE	BY
A0	CREATED	2010-07-08	Jacise
A3	Modified	2012-11-13	ye

3. SCHEMATIC DIAGRAM:

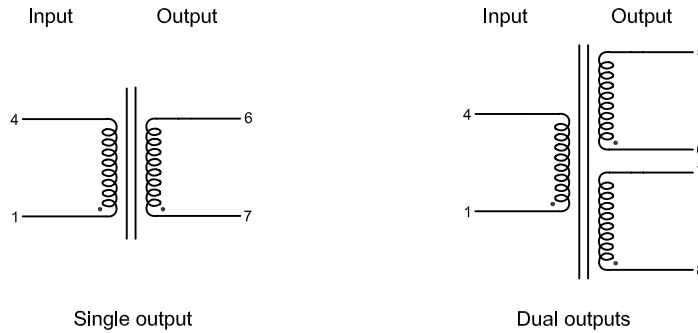

4. ELECTRICAL TABLE:

Part Number (ZETTLER)	Input Voltage	Secondary Voltage (V)		Secondary current (mA)	No-load Voltage (V)(max)	Rated Power (VA)
BV201S06003A	115V	6±10%		58	10.5	0.35
BV201S09003A	115V	9±10%		38.9	15.5	0.35
BV201S10003A	115V	10±10%		35	17.5	0.35
BV201S12003A	115V	12±10%		29	20.5	0.35
BV201S15003A	115V	15±10%		23.3	24.5	0.35
BV201S18003A	115V	18±10%		19.4	27.5	0.35
BV201S24003A	115V	24±10%		14.6	35.5	0.35
BV201D06003A	115V	6±10%	6±10%	2×29	2×10.5	0.35
BV201D09003A	115V	9±10%	9±10%	2×19.4	2×14.5	0.35
BV201D10003A	115V	10±10%	10±10%	2×17.5	2×17.5	0.35
BV201D12003A	115V	12±10%	12±10%	2×14.6	2×20.5	0.35
BV201D15003A	115V	15±10%	15±10%	2×11.7	2×24.5	0.35
BV201D18003A	115V	18±10%	18±10%	2×14.6	2×27.5	0.35
BV201D24003A	115V	24±10%	24±10%	2×11.7	2×35.5	0.35
BV202S06003A	230V	6±10%		58	10.5	0.35
BV202S09003A	230V	9±10%		38.9	15.5	0.35
BV202S10003A	230V	10±10%		35	17.5	0.35
BV202S12003A	230V	12±10%		29	20.5	0.35
BV202S15003A	230V	15±10%		23.3	24.5	0.35
BV202S18003A	230V	18±10%		19.4	27.5	0.35
BV202S24003A	230V	24±10%		14.6	35.5	0.35
BV202D06003A	230V	6±10%	6±10%	2×29	2×10.5	0.35
BV202D09003A	230V	9±10%	9±10%	2×19.4	2×15.5	0.35
BV202D10003A	230V	10±10%	10±10%	2×17.5	2×17.5	0.35
BV202D12003A	230V	12±10%	12±10%	2×14.6	2×20.5	0.35
BV202D15003A	230V	15±10%	15±10%	2×11.7	2×24.5	0.35
BV202D18003A	230V	18±10%	18±10%	2×9.7	2×27.5	0.35
BV202D24003A	230V	24±10%	24±10%	2×7.3	2×35.5	0.35

UNIT MM	TOLERANCE X.X = ±0.5 X.XX = ±0.3 ANG = -	
3RD ANGLE 		
SCALE:	DATA	
DRAWN: ye	2015-10-26	
CHECKED:		
APPROVED:		

ZETTLER MAGNETICS

TITLE: SEALED TRANSFORMER, PCB 0.35VA			
PART NO: BV20XXXX003A		ZM Project:	SPEC REV: A/4
		Customers p/n:	SH NO 2/3

Web: www.zettlermagnetics.com
E-mail: sales@zettlermagnetics.com

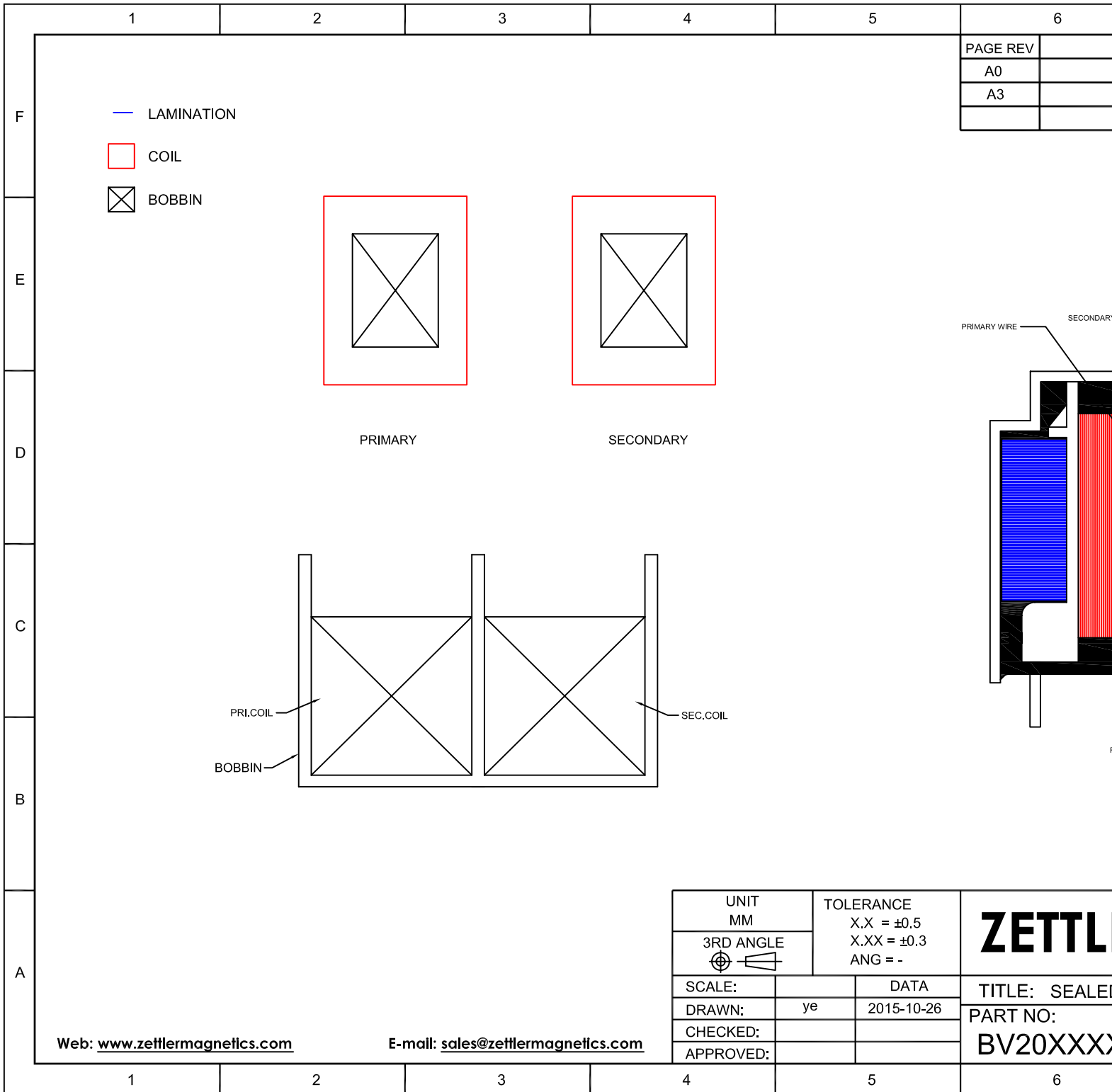

PAGE REV	
A0	
A3	

- LAMINATION
- COIL
- X
 BOBBIN

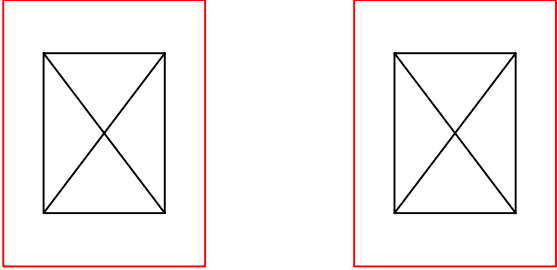

PRIMARY

SECONDARY

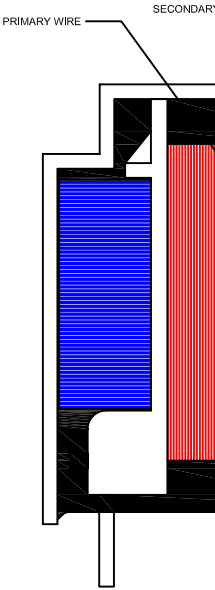
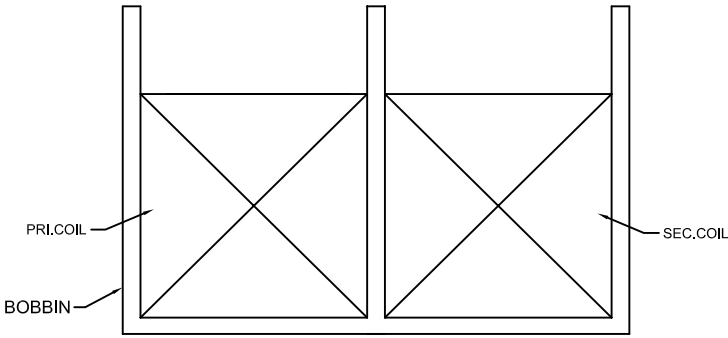

UNIT MM	TOLERANCE	
3RD ANGLE 	X.X = ±0,5	
	X.XX = ±0,3	
	ANG = -	
SCALE:	DATA	
DRAWN: ye	2015-10-26	
CHECKED:		
APPROVED:		

ZETTL

TITLE: SEALED

PART NO:
BV20XXX

X-ON Electronics

Largest Supplier of Electrical and Electronic Components

Click to view similar products for [Power Transformers](#) category:

Click to view products by [Zettler](#) manufacturer:

Other Similar products are found below :

[ET-030A](#) [F-102X](#) [F-120X](#) [F-14X-1](#) [F-181U](#) [F-18A](#) [F-199U](#) [F-19X](#) [F-202U](#) [F-204U](#) [F-206U](#) [F-227X](#) [F-238U](#) [F-239U-1](#) [F-23U](#) [F24-250-B](#)
[F-242U](#) [F-245U](#) [F-264U](#) [F-265U](#) [F-267U](#) [F-281U](#) [F-283U](#) [F-290X](#) [F-295Z](#) [F-296Z](#) [F-298Z](#) [F-3143P](#) [F-3298Z](#) [F-33U](#) [F-346X](#) [F-35U](#) [F-](#)
[364U](#) [F-392A](#) [F-395X](#) [F-397U](#) [F-412X](#) [F-47U](#) [F-55X-1](#) [F-60U](#) [F-68U](#) [F-71U](#) [F-72Z](#) [F-74U](#) [F-83A](#) [F-84AC](#) [F-85U](#) [F-86U](#) [F-9U](#) [PCT-02](#)