

## GENERAL PURPOSE — SINGLE & DOUBLE POLE

# E Series

### Features

- 5 current ratings
- Choice of actuator styles
- 3 terminal types (optional screw terminals available — consult factory)
- 3 contact arrangements
- Long-life coil spring mechanism
- High-temperature 150°C and 200°C available on select models (consult factory)

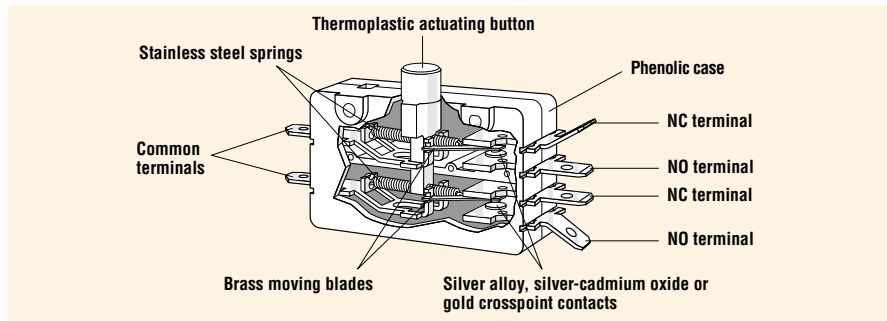

### Electrical Ratings

Switch Series	EN61058 Rating	UL1054 Rating	Electrical Life at Rated Load	
			According to VDE (Min. Operations)	According to UL (Min. Operations)
<b>E13/E19</b>	N/A	15A, 125/250VAC; 3/4HP, 125VAC 1-1/2HP, 250VAC	N/A	6,000*
<b>E19A</b> (mixed ratings)	N/A	15A, 125/250VAC; 0.1A, 125VAC	N/A	6,000
<b>E14/E25</b>	N/A	25A, 125/250VAC; 1HP, 125VAC 2HP, 250VAC	N/A	6,000
<b>E20</b>	N/A	20A, 125/250VAC; 1HP, 125VAC 2HP, 250VAC	N/A	6,000
<b>E28/E29</b>	N/A	30.1A, 125/250/277VAC (UL Approved Only — Resistive Load Only)	N/A	6,000
<b>E30</b>	N/A	30.1A, 125/250VAC; 1HP, 125VAC 2HP, 250VAC	N/A	6,000
<b>G13/G20</b>	N/A	0.1A, 125VAC	N/A	6,000*

\*Indicates 100K life available.

### Specifications

#### Electrical

Temperature Rating: 105°C Std. (150°C and 200°C optional — E13, E14, E19, E20, G13)  
85°C Std. (E28 and E29), 85°C Std. (150°C optional) E25

Flammability Rating: UL94HB

#### Materials

Case: General Purpose Phenolic

Actuating Button: Thermoplastic Nylon

Common Terminals: Brass (E13, E19, E19A, G13, G20)  
Silver-Plated Brass (E14, E20, E28, E29, E30)

NO and NC Terminals: Brass (E13, E19, E19A, G13, G20)  
Copper (E14, E20, E28, E29, E30)

Moving Blade: Brass (E13, E19, E19A, G13, G20)  
Silver-Plated Beryllium Copper (E14, E20, E28, E29, E30)

Spring: Stainless Steel

Auxiliary Actuators: Cold-Rolled Steel (Nickel-Plated)

Roller: Sintered Stainless Steel

Contacts: Gold Crosspoint (G13, G20, E19A)  
Silver-Cadmium Oxide (E13, E14, E19, E20, E28)  
Silver Alloy (E19A, E29, E30)



## Dimensions — Single Pole inches (mm)

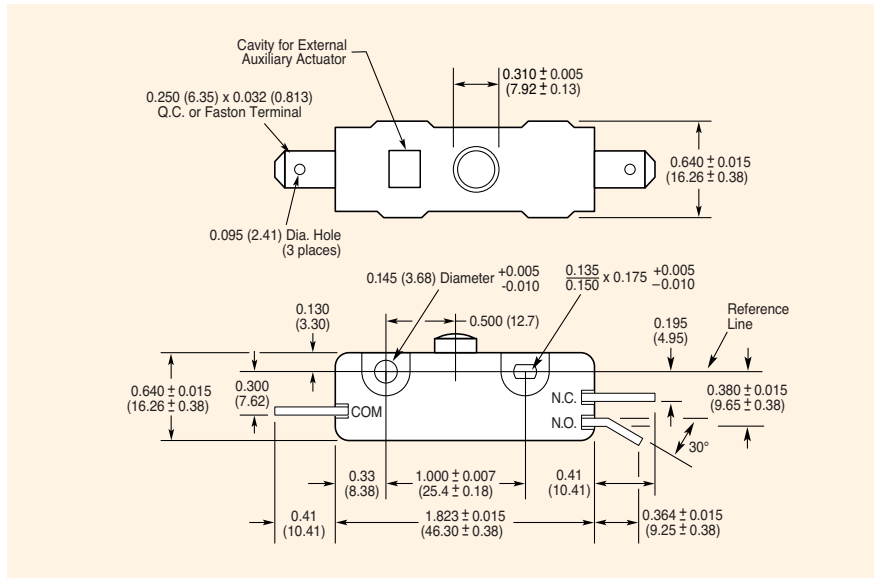

## Actuator Specifications — Single Pole

Series/ Prefix	Actuator Type	Switch Type	Maximum Operating Force (g)	Maximum Pre-Travel inches (mm)	Operating Point* inches (mm)	Minimum Over-Travel inches (mm)	Max. Movement Differential inches (mm)	Actuation Length** inches (mm)
E13/G13	-00E		425	0.050 (1.27)	0.285±0.020 (7.24±0.51)	0.100 (2.54)	0.015 (0.38)	—
E14/E29/E30	-00A		850	0.100 (2.54)	0.248±0.026 (6.30±0.66)	0.050 (1.27)	0.015 (0.38)	—
E13/G13	-00J		425	0.050 (1.27)	0.670±0.030 (17.02±0.76)	0.108 (2.74)	0.015 (0.38)	—
E14/E29/E30			850	0.100 (2.54)	0.633±0.030 (16.08±0.76)	0.050 (1.27)	0.015 (0.38)	—
E13/G13	-00M		425	0.050 (1.27)	0.812±0.030 (20.63±0.76)	0.218 (5.54)	0.015 (0.38)	—
E14/E29/E30			850	0.100 (2.54)	0.775±0.030 (19.69±0.76)	0.168 (4.27)	0.015 (0.38)	—
E13/G13	-00H		100	0.250 (6.35)	0.312±0.062 (7.93±1.57)	0.187 (4.75)	0.093 (2.36)	1.500 (38.10)
E14/E29/E30†			285	0.312 (7.93)	0.468±0.062 (11.89±1.57)	0.150 (3.81)	0.050 (1.27)	0.821 (20.85)
E13/G13	-50H		65	0.343 (8.71)	0.281±0.062 (7.14±1.57)	0.187 (4.75)	0.140 (3.56)	1.750 (44.45)
E14/E29/E30†			170	0.525 (13.34)	0.437±0.062 (11.10±1.57)	0.218 (5.54)	0.080 (2.03)	1.071 (27.20)
E13/G13	-00K		100	0.250 (6.35)	0.718±0.062 (18.24±1.57)	0.187 (4.75)	0.093 (2.36)	1.391 (35.33)
E14/E29/E30†			285	0.348 (8.84)	0.860±0.062 (21.84±1.57)	0.130 (3.30)	0.045 (1.14)	0.652 (16.56)
E13/G13	-50K		65	0.343 (8.71)	0.687±0.062 (17.45±1.57)	0.187 (4.75)	0.140 (3.56)	1.645 (41.78)
E14/E29/E30†			170	0.483 (12.27)	0.828±0.062 (21.03±1.57)	0.218 (5.54)	0.073 (1.85)	0.902 (22.91)

\* Measured above reference line. Refer to dimensional drawing above. \*\* Actuator tolerance ±0.031 inches (0.79mm).  
† E14, E29 and E30 actuators are shorter and formed up 11° at the button.

## Ordering Information

Select the current rating you need. Combine the corresponding Series/Prefix number with the appropriate suffix number for the switch you need.

Specifications subject to change without notice.

## Mounting — Single Pole

Recommended mounting screw: #6-32 round head. Recommended torque on screw: 6 inch lbs. max.

## Actuators — Single Pole

Standard type integral hinged lever and roller actuators are available in choice of two mounting positions. Actuation lengths are dimensioned from centerline of switch mounting hole as shown.

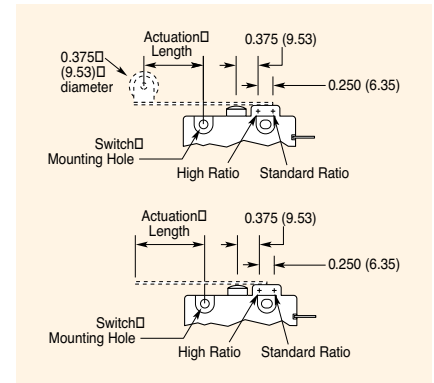

## “J” & “M” Type Optional Hardware — Single Pole

Brass Hex Nut	0012-0023
Brass Knurled Nut	0012-0025
Brass Hex Nut (Nickel-Plated)	0012-0028
Brass Knurled Nut (Nickel-Plated)	0012-0021
Star Washer	0012-0073

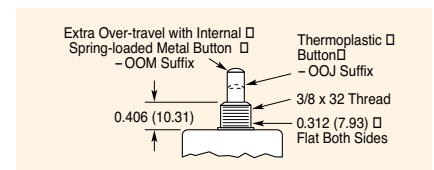

## Circuitry — Single Pole

Contact arrangement available in choice of single pole double throw or single pole single throw, either normally open or normally closed. In general, normally open may be specified by changing suffix number from 00 to 01 and normally closed by changing suffix number to 02.

Example: E13-00E is double throw, E13-01E is normally open, and E13-02E is normally closed.

## Terminals — Single Pole

Standard 0.250" x 0.032" (6.35mm x 0.81mm) [Optional 0.187" x 0.032" (4.75mm x 0.81mm)] QC terminals can be furnished with angle formed up or down. Forms include straight 30°, 45°, 85° up or down. Other forms can be provided. Screw terminal UL approved on E14 and E30 only.

## Dimensions — Double Pole inches (mm)

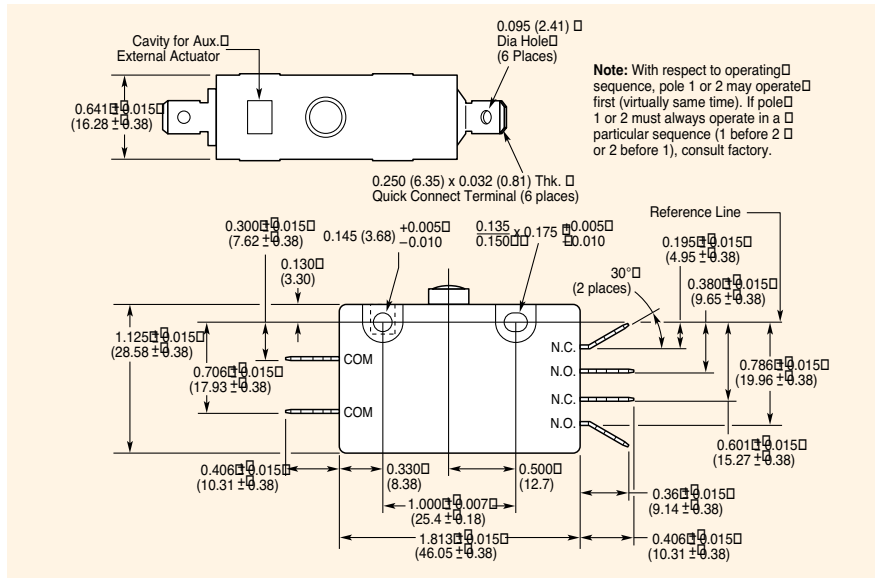

## Actuator Specifications — Double Pole

Series/Prefix	Actuator Type	Switch Type	Maximum Operating Force (g)	Maximum Pretravel inches (mm)	Operating Point* inches (mm)	Minimum Overtravel inches (mm)	Max. Movement Differential inches (mm)	Actuation Length inches (mm)
E19/G20	-00A		850	0.050 (1.27)	0.285±0.030 (7.24±0.76)	0.080 (2.03)	0.015 (0.38)	—
E20/E28			1280	0.100 (2.54)	0.248±0.030 (6.30±0.76)	0.050 (1.27)	0.015 (0.38)	—
E19/G20	-00J		850	0.050 (1.27)	0.670±0.030 (17.02±0.76)	0.080 (2.03)	0.015 (0.38)	—
E20/E28†			1280	0.100 (2.54)	0.630±0.030 (16.00±0.76)	0.050 (1.27)	0.015 (0.38)	—
E19/G20	-00M		850	0.050 (1.27)	0.812±0.030 (20.62±0.76)	0.218 (5.54)	0.015 (0.38)	—
E20/E28†			1280	0.100 (2.54)	0.774±0.030 (19.66±0.76)	0.188 (4.78)	0.015 (0.38)	—
E19/G20	-00H		205	0.275 (6.99)	0.312±0.062 (7.92±1.57)	0.187 (4.75)	0.093 (2.36)	1.500 (38.10)
E20/E28†			425	0.330 (8.38)	0.468±0.062 (11.89±1.57)	0.156 (3.96)	0.050 (1.27)	0.821 (20.85)
E19/G20	-50H		130	0.400 (10.16)	0.281±0.062 (7.14±1.57)	0.187 (4.75)	0.140 (3.56)	1.750 (44.45)
E20/E28†			285	0.600 (15.24)	0.437±0.062 (11.10±1.57)	0.156 (3.96)	0.080 (2.03)	1.071 (27.20)
E19/G20	-00K		212	0.250 (6.35)	0.718±0.062 (18.24±1.57)	0.187 (4.75)	0.093 (2.36)	1.391 (35.33)
E20/E28†			425	0.348 (8.84)	0.860±0.062 (21.84±1.57)	0.156 (3.96)	0.045 (1.14)	0.652 (16.56)
E19/G20	-50K		150	0.312 (7.92)	0.687±0.062 (17.45±1.57)	0.187 (4.75)	0.140 (3.56)	1.645 (41.78)
E20/E28†			312	0.525 (13.34)	0.828±0.062 (21.03±1.57)	0.146 (3.71)	0.075 (1.91)	0.902 (22.91)

\* Measured above reference line. Refer to dimensional drawing above.  
 † E20 and E28 actuators are shorter and formed up 15° at the button.  
 Contact factory for E25 specifications.  
 \*\* Actuator tolerance ±0.031 inches (0.79mm).

## Ordering Information

Select the current rating you need. Combine the corresponding Series/Prefix number with the appropriate suffix number for the switch you need. Note: Consult factory for part number when ordering E19A switches.

## Mounting — Double Pole

Recommended mounting screw: #6-32 round head. Recommended torque on screw: 6 inch lbs. max.

## Actuators — Double Pole

Standard type integral hinged lever and roller actuators are available in choice of two mounting positions. Actuation lengths are dimensioned from centerline of switch mounting hole as shown.

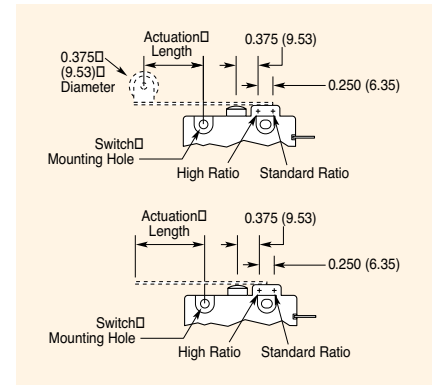

## “J” & “M” Type Optional Hardware — Double Pole

Brass Hex Nut	0012-0023
Brass Knurled Nut	0012-0025
Brass Hex Nut (Nickel-Plated)	0012-0028
Brass Knurled Nut (Nickel-Plated)	0012-0021
Star Washer	0012-0073

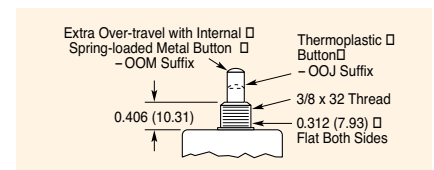

## Circuitry — Double Pole

Contact arrangement available in choice of single pole double throw or single pole single throw, either normally open or normally closed. In general, normally open may be specified by changing suffix number from 00 to 01 and normally closed by changing suffix number to 02.

Example: E19-00A is double throw, E19-01A is normally open, and E19-02A is normally closed.

## Terminals — Double Pole

Standard 0.250" x 0.032" (6.35mm x 0.81mm) [Optional 0.187" x 0.032" (4.75mm x 0.81mm)] QC terminals can be furnished with angle formed up or down on common as well as open or closed terminal. Forms include straight 30°, 45°, 85° up or down. Other forms can be provided.

## X-ON Electronics

Largest Supplier of Electrical and Electronic Components

*Click to view similar products for [Switch Fixings](#) category:*

*Click to view products by [ZF Cherry](#) manufacturer:*

Other Similar products are found below :

[893102000](#) [00-5150](#) [LZZ1A](#) [0098.9234](#) [61-9451.0](#) [M2PA-5011](#) [630155](#) [635401](#) [6PA113](#) [6PA147-E6](#) [6PA148-E6](#) [6PA32](#) [6PA9](#) [700109](#)  
[700303A56](#) [700C1GRY](#) [700C2GRN](#) [704-6001](#) [704.960.9](#) [704.965.2](#) [704.965.6](#) [704.966.0](#) [7089-3](#) [710082-B11](#) [71M1048](#) [757200264](#)  
[764300000](#) [MHU35](#) [MHU37](#) [807039-1](#) [825.003.011](#) [825.005.011](#) [825.053.011](#) [825.055.011](#) [826.000.071](#) [827.020.011](#) [827.400.021](#)  
[835.900.023](#) [MML52C10C](#) [MML52E10C](#) [MML92HGH](#) [MML93K](#) [84211M02CNNS](#) [84212M02CNNS](#) [84217A8.0LNOS](#) [842.500.011](#)  
[843.000.011](#) [843187-000](#) [843487-000](#) [84-901](#)