

# D4 Series

<http://switches-sensors.zf.com/us/product/miniature-d4/> FOR PRODUCT INFORMATION.

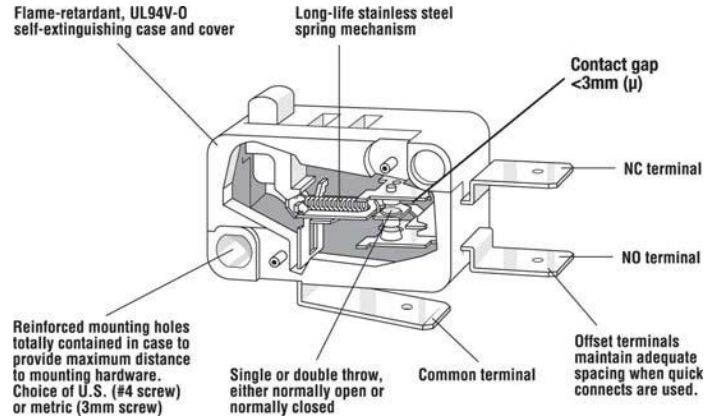

## Features

- 6 current ratings
- Various terminal types
- Cadmium-free contact material available
- Choice of standard or light operating force
- Long life coil spring mechanism
- Agency approved extended life versions
- ENEC/VDE approval standard
- Tracking index PTI 300 according to IEC 6011
- UL File number E314201

## Electrical Ratings

Switch Series	EN61058 Rating	UL1054 Rating	Electrical Life at Rated Load at 85° C	
			According to EN (Min. Operations)	According to UL (Min. Operations)
D41	0.1(0.05)A, 250V~; 0.5A 30VDC	0.1A, 125/250VAC; 0.5A 30VDC, 1A 125VAC ( <i>6k life only</i> )	50,000	6,000*
D42	3(1)A, 250V~	3A, 125/250VAC; 1/10HP, 250VAC	50,000	6,000*
D43	6(2)A, 250V~	5A, 125/250VAC, 1/4HP, 250VAC	50,000	6,000*
D44	10(3)A, 250V~	10A, 1/2HP, 125/250VAC	50,000	6,000*
D45	16(4)A, 250V~ 10(3)A, 400V~ ( <i>Std. force only</i> )	15A, 1/2HP, 125/250VAC	50,000	6,000*
D48	21(8)A, 250V~	21A, 250VAC; 1HP, 125VAC; 2HP, 250VAC	10,000	6,000

Operating life for 125°C and 150°C available upon request.

\*Denotes extended life versions available

## Electrical Specifications

Temperature Rating:	-40° to +85°C, 125°C or 150°C	Flammability Rating:	UL 94V-0
---------------------	-------------------------------	----------------------	----------

## Materials

Case/Cover:	Thermoplastic Polyester (PET)	NO/NC Terminals	Brass
Actuating Button:	Thermoplastic Acetal (POM), 85°C	Moving Blade:	Silver Plated Brass
	Thermoplastic Polyester (PET), 125°C or 150°C		Gold Crosspoint (D41)
Auxiliary Actuator:	Stainless Steel or Cold-Rolled Steel (Nickel-Plated)	Contacts:	Silver (D42)
Common Terminal:	Brass		Silver Alloy (D43-D48)



# D4 Series

## European Version (mm)

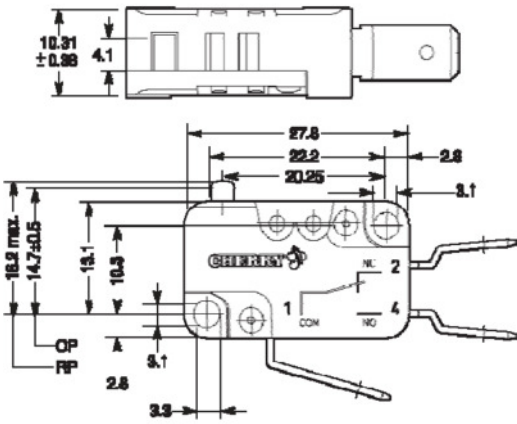

## U.S. Version (inches)

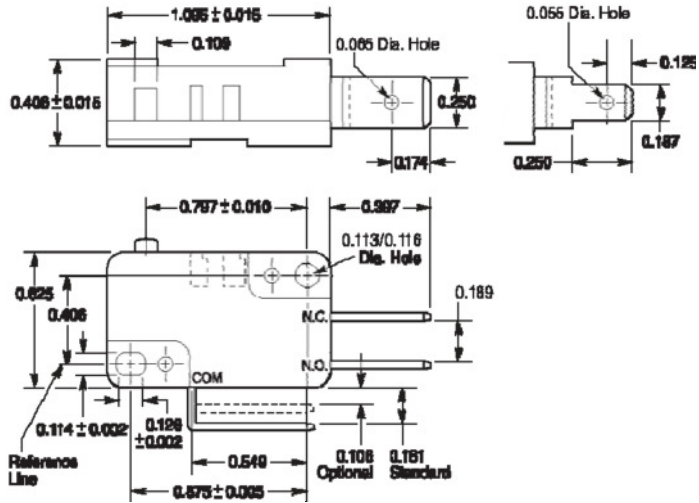

### Terminals

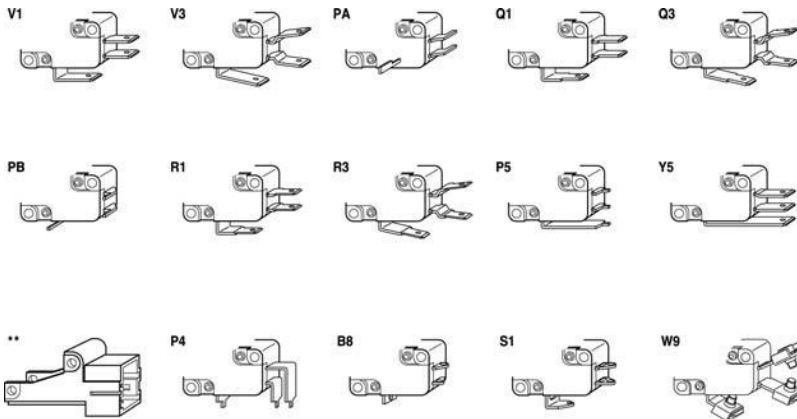

- \* Connector part #823-0518 (mates with Y5 only)
- \*\* Connector housing for RAST 5 QC terminals

### Actuators

Many special forms and lengths of actuators are available. Standard type integral hinged lever and roller actuators are available in choice of 2 mounting positions. Actuation lengths are dimensioned from centerline of switch mounting hole as shown below.

### Identifiers

Switches with a "standard" operating force are identified by a 'Y' next to the standard model description, e.g. D43Y.

Switches with a "light" operating force are identified by an 'X' next to the standard model description, e.g. D43X.

Switches with 100,000 cycles approved per UL1054 are marked with 'L' in circle.

### Mounting — US Version

Recommended mounting screw size: #4-40 Round head with washer. Recommended torque on screw: 60 NCM max.

### Mounting — European Version

Recommended mounting screw size with washer: M3. Recommended torque on screw: 60 NCM max.

### Drilling Patterns for PCB Terminals

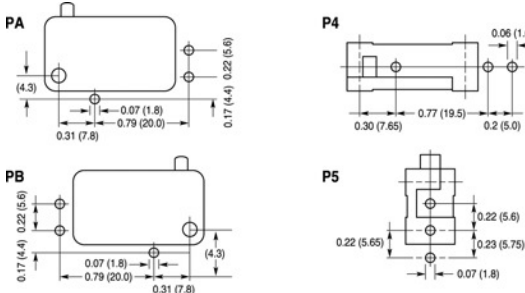

### Length of Auxiliary Actuator

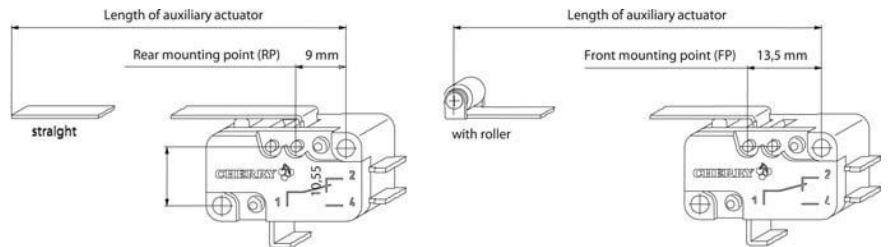

# D4 Series









## Commonly Stocked Distributor Items

Item Number	EN Rating	UL Rating	Terminals	Maximum Operating Force (cN)	Maximum Pretravel inches (mm)	Operating Point inches (mm)	Minimum Overtravel inches (mm)	Max. Movement Differential inches (mm)	Actuation Length inches (mm)	Housing Mark
D41CR1AA	0.1 (0.05) A, 250 VAC 0.5 A, 30 VDC 1(1) A, 250 VAC	0.1 A, 125/250 VAC 0.5 A, 30 VDC 1 A, 125 VAC	0.187" x 0.020"	170	0.047" (1.2)	0.559" / 0.599" (14.2 / 15.2)	0.05" (1.3)	0.012" (0.3)	N/A	D41Y
D41CR1LA	0.1 (0.05) A, 250 VAC 0.5 A, 30 VDC 1(1) A, 250 VAC	0.1 A, 125/250 VAC 0.5 A, 30 VDC 1 A, 125 VAC	0.187" x 0.020"	190	0.047" (1.2)	0.579" / .618" (14.7 / 15.7)	0.035" (0.9)	0.012" (0.3)	0.835" (21.2)	D41Y
D41CR1LD	0.1 (0.05) A, 250 VAC 0.5 A, 30 VDC 1(1) A, 250 VAC	0.1 A, 125/250 VAC 0.5 A, 30 VDC 1 A, 125 VAC	0.187" x 0.020"	86	0.126" (3.2)	0.551" / 0.646" (14.0 / 16.4)	0.090" (2.3)	0.031" (0.8)	1.40" (35.6)	D41Y
D41CR1RA	0.1 (0.05) A, 250 VAC 0.5 A, 30 VDC 1(1) A, 250 VAC	0.1 A, 125/250 VAC 0.5 A, 30 VDC 1 A, 125 VAC	0.187" x 0.020"	190	0.047" (1.2)	0.776" / 0.839" (19.7 / 21.3)	0.039" (1.0)	0.012" (0.4)	0.811" (20.6)	D41Y
D41LR1AA	0.1 (0.05) A, 250 VAC 0.5 A, 30 VDC 1(1) A, 250 VAC	0.1 A, 125/250 VAC 0.5 A, 30 VDC 1 A, 125 VAC	0.187" x 0.020"	45	0.047" (1.2)	0.559" / 0.599" (14.2 / 15.2)	0.05" (1.3)	0.012" (0.3)	N/A	D41X
D42LR1AA	3(1) A, 250 VAC	3A, 125/250 VAC, 1/10 HP, 250 VAC	0.187" x 0.020"	45	0.047" (1.2)	0.559" / 0.599" (14.2 / 15.2)	0.05" (1.3)	0.012" (0.3)	N/A	D42X
D42LRGAA	3(1) A, 250 VAC	3A, 125/250 VAC, 1/10 HP, 250 VAC	0.187" x 0.020"	2	0.500" (12.7)	0.433" / 0.764" (11.0 / 19.4)	0.311" (7.9)	0.098" (2.5)	2.93" (74.4)	D42X
D43CR1AA	6(2) A, 250 VAC	5A, 125/250 VAC 1/4 HP, 250 VAC	0.187" x 0.020"	170	0.047" (1.2)	0.559" / 0.599" (14.2 / 15.2)	0.05" (1.3)	0.012" (0.3)	N/A	D43Y
D44CR1AA	10(3) A, 250 VAC	10 A, 1/2 HP, 125/250 VAC 6 A, 30 VDC	0.187" x 0.020"	285	0.047" (1.2)	0.559" / 0.599" (14.2 / 15.2)	0.05" (1.3)	0.012" (0.3)	N/A	D44Y
D44CR1LD	10(3) A, 250 VAC	10 A, 1/2 HP, 125/250 VAC 6 A, 30 VDC	0.187" x 0.020"	144	0.126" (3.2)	0.551" / 0.646" (14.0 / 16.4)	0.090" (2.3)	0.031" (0.8)	1.40" (35.6)	D44Y
D44CR1RA	10(3) A, 250 VAC	10 A, 1/2 HP, 125/250 VAC 6 A, 30 VDC	0.187" x 0.020"	330	0.047" (1.2)	0.776" / 0.839" (19.7 / 21.3)	0.039" (1.0)	0.012" (0.4)	0.811" (20.6)	D44Y
D44CR1RD	10(3) A, 250 VAC	10 A, 1/2 HP, 125/250 VAC 6 A, 30 VDC	0.187" x 0.020"	144	0.126" (3.2)	0.764" / 0.850" (19.4 / 21.6)	0.087" (2.2)	0.031" (0.8)	1.34" (34.1)	D44Y
D44LR1AA	10(3) A, 250 VAC	10 A, 1/2 HP, 125/250 VAC 6 A, 30 VDC	0.187" x 0.020"	75	0.047" (1.2)	0.559" / 0.599" (14.2 / 15.2)	0.05" (1.3)	0.012" (0.3)	N/A	D44X
D44LR1LD	10(3) A, 250 VAC	10 A, 1/2 HP, 125/250 VAC 6 A, 30 VDC	0.187" x 0.020"	40	0.126" (3.2)	0.551" / 0.646" (14.0 / 16.4)	0.090" (2.3)	0.031" (0.8)	1.40" (35.6)	D44X
D44LR1LL	10(3) A, 250 VAC	10 A, 1/2 HP, 125/250 VAC 6 A, 30 VDC	0.187" x 0.020"	17	0.030" (7.6)	0.472" / .724" (12.0 / 18.4)	0.185" (4.7)	0.067" (1.7)	2.75" (69.9)	D44X
D44LR1MD	10(3) A, 250 VAC	10 A, 1/2 HP, 125/250 VAC 6 A, 30 VDC	0.187" x 0.020"	25	0.020" (5.1)	0.535" / 0.661" (13.6 / 16.8)	0.142" (3.6)	0.051" (1.3)	1.58" (40.1)	D44X
D44LR1ML	10(3) A, 250 VAC	10 A, 1/2 HP, 125/250 VAC 6 A, 30 VDC	0.187" x 0.020"	10	0.050" (12.7)	0.433" / .763" (11.0 / 19.4)	0.311" (7.9)	0.098" (2.5)	2.92" (74.4)	D44X
D44LR1RA	10(3) A, 250 VAC	10 A, 1/2 HP, 125/250 VAC 6 A, 30 VDC	0.187" x 0.020"	75	0.047" (1.2)	0.776" / 0.839" (19.7 / 21.3)	0.039" (1.0)	0.012" (0.4)	0.811" (20.6)	D44X
D44LR1RD	10(3) A, 250 VAC	10 A, 1/2 HP, 125/250 VAC 6 A, 30 VDC	0.187" x 0.020"	40	0.126" (3.2)	0.764" / 0.850" (19.4 / 21.6)	0.087" (2.2)	0.031" (0.8)	1.34" (34.1)	D44X
D45CR1AA		15 A, 1/2 HP, 125/250 VAC	0.187" x 0.020"	400	0.047" (1.2)	0.559" / 0.599" (14.2 / 15.2)	0.05" (1.3)	0.012" (0.3)	N/A	D45Y
D45LR1AA		15 A, 1/2 HP, 125/250 VAC	0.187" x 0.020"	100	0.047" (1.2)	0.559" / 0.599" (14.2 / 15.2)	0.05" (1.3)	0.012" (0.3)	N/A	D45X
D45LR1LL		15 A, 1/2 HP, 125/250 VAC	0.187" x 0.020"	22	0.030" (7.6)	0.472" / .724" (12.0 / 18.4)	0.185" (4.7)	0.067" (1.7)	2.75" (69.9)	D45X
D45LR1ML		15 A, 1/2 HP, 125/250 VAC	0.187" x 0.020"	13	0.050" (12.7)	0.433" / .763" (11.0 / 19.4)	0.311" (7.9)	0.098" (2.5)	2.92" (74.4)	D45X



# D4 Series

## Ordering Information

D4		3		3		Q		1		L		D						
Series/Prefix																		
Code	Electrical Rating		Code			Operating Force	Temperature Rating	Mounting Holes	Code	Terminal Type	Code	Terminal Configuration	Code			Pivot Position	Auxiliary Actuator	
	EN61058-1	UL 1054	SPST NO	SPST NC	SPDT								A	D	L			
1	0.1(0.5)A, 250 VAC 0.5 A, 30 VDC; 1 (1) A, 250 VAC	0.1 A, 125-250 VAC 0.5 A, 30 VDC; 1 A, 125 VAC	1	2	3	Standard "Y" Light "X"	T85	International Version	A	Welding	1		AA				without	
2	3(1)A, 250 VAC	3 A, 125-250 VAC 1/10 HP, 250 VAC	7	8	9	Standard "Y" Light "X"	T125		B	Solder short	3		L	21,2	35,6	69,9	RP	straight steel
3	6(2)A, 250 VAC	5 A, 125-250 VAC, 1/4 HP, 250 VAC	G	H	M	Standard "Y" Light "X"	T150		P	PCB	4		M	25,7	40,1	74,4	FP	straight steel
4	10(3)A, 250 VAC	10 A, 125-250 VAC; 6A 30 VDC, 1/2 HP, 125-250 VAC	N	P	R	Standard "Y" Light "X"	T85		Q	Tab. 4.8x0.8	5		J	21,2	35,5	69,9	RP	straight stainless steel
5	16(4) A, 250 VAC	15 A, 125-250 VAC 1/2 HP, 125-250 VAC	S	T	U	Standard "Y" Light "X"	T125	R	Tab. 4.8x0.5	8		K	25,7	40,1	74,4	FP	straight stainless steel	
8	21(8) A, 250 VAC	21 A, 250 VAC 1 HP, 125 VAC; 2 HP, 250 VAC	A	B	C	Standard "Y" Light "X"	T85	S	Solder with Temp. Stop	9		R	20,6	34,1		RP	with roller	
			D	E	F	Standard "Y" Light "X"	T125	V	Tab. 6.3x0.8	A		T	25,1	38,5		FP	with roller	
			4	5	6	Standard "Y" Light "X"	T150	W	Screw	B		S	20,6			RP	with simulated roller	
								Y	Tab. 6.3x0.8 RAST 5			U	25,1			FP	with simulated roller	

Specifications subject to change without notice

### Mounting — US Version

Recommended mounting screw size: #4-40 Round head with washer. Recommended torque on screw: 60 NCM max.

### Mounting — European Version

Recommended mounting screw size with washer: M3. Recommended torque on screw: 60 NCM max.



### Notes:

- D48 only available as light force
- D45 not VDE approved with terminal code 'R'
- D48 only available with terminal codes 'A', 'S', or 'V'

U.S.-ONLY D4 VERSION DISCONTINUED AND REPLACED WITH GLOBAL VERSION.

<http://switches-sensors.zf.com/us/product/miniature-d4/> FOR PRODUCT INFORMATION.



## X-ON Electronics

Largest Supplier of Electrical and Electronic Components

*Click to view similar products for [Basic / Snap Action Switches](#) category:*

*Click to view products by [ZF Cherry](#) manufacturer:*

Other Similar products are found below :

[5SM901-S12](#) [5SM9-S12N195](#) [602EN532](#) [602EN535-RB](#) [602HE5-RB1](#) [604HE162](#) [604HE223-6B](#) [624HE17-RB](#) [6HM82](#) [6HM89](#) [6SE1](#)  
[6SX1-H58](#) [70500216](#) [70599106](#) [MBD5B1](#) [MBH2731](#) [73-316-0012](#) [EXD-AR20](#) [79211923](#) [79218589](#) [7AS12](#)  
[MIL30126AB6BBMD4A12XAU](#) [ML-1155](#) [ML-1376](#) [831010C3.0](#) [831090C2.EL](#) [83131904](#) [8AS239](#) [8HM73-3](#) [8SX26-H33](#) [914CE1-6G](#)  
[PL-100](#) [11SM1077-H4](#) [11SM1077-H58](#) [11SM1-TN107](#) [11SM405](#) [11SM8423-H2](#) [11SX37-T](#) [11SX48-H58](#) [11SM2442-T](#) [11SM76-T](#)  
[11SM77-H58](#) [11SM77-T](#) [11SM863-T](#) [11SM866](#) [A7CN-1M-1-LEFT](#) [A831700C7.0](#) [121EN187-R](#) [121EN188-R](#) [1245.0120](#)