

MINIATURE Switch

E21-E36 Series

Not recommended for new designs
 Please review our D4 series
<http://switches-sensors.zf.com/us/product/miniature-d4/>

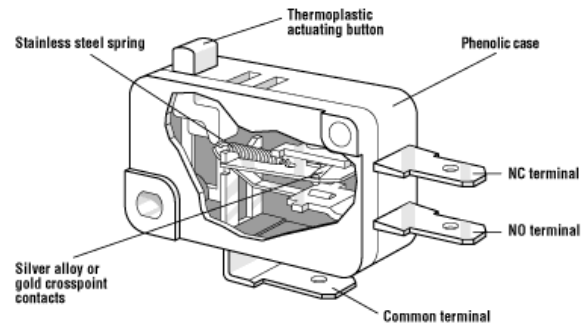

Features

<ul style="list-style-type: none"> • 8 Contact Ratings DC ratings optional • High temperature versions optional 	<ul style="list-style-type: none"> • Standard or light force versions available • Agency approved long life versions optional
---	---

Electrical Ratings and Operating Life

Switch Series	According to UL 1054	
	Nominal Load	Electrical Life at Rated Load
E21	0.1A 125 VAC (0.25A, 30VDC optional)	6000**
E22	3A 125/250 VAC, 1/10 HP 250 VAC (0.1A, 125VDC optional)	6000
E23	5A ¼ HP, 125/250 VAC	6000
E31	1A 125 VAC	6000
E33	10A ½ HP 125/250 VAC (6A 30VDC optional)	6000**
E34	15A ½ HP 125/250 VAC	6000*
E35	20.1A ½ HP 125/250 VAC	6000
E36	25A 125/250 VAC; 1 HP 125 VAC, 2 HP 250 VAC	6000

* Indicates 100K UL Life available on AC versions optional. ** Indicates 100K UL Life available on AC and DC versions optional Contact Factory for new part number.

Technical Specifications

Temperature Rating: -40°C to 85°C (130°C and 150°C optional. Not available on E36. Contact factory for special part numbers.)

Flammability Rating: UL94HB

Mounting: Recommended screw: #4-40 round head, UL approved. Recommended torque: 3 inch lbs. max

UL File No.: E23301

RoHS: Compliant

Specifications subject to change

Material Specifications

Case: General Purpose Phenolic

Common Terminal: Silver Plated Brass (E21, E22, E23, E31, E33, E34, E35) Silver Plated Copper (E36)

NO & NC Terminal: Brass (E21, E22, E23, E31, E33, E34, E35) Copper (E36)

Moving Blade: Brass (E21, E33, E23) Silver Plated Beryllium Copper (E31, E33, E34, E35, E36)

Actuating Button: Thermoplastic Acetal

Auxiliary Actuator: Cold Rolled Steel (Nickel Plated) (E21 and E22 use Aluminum)

Contacts: Silver Alloy
 Gold Crosspoint: E21 and E31
 Fine Silver: E22



Not recommended for new designs
Please review our D4 series
<http://switches-sensors.zf.com/us/product/miniature-d4/>

MINIATURE

E21-E36 Series

Dimensions inches

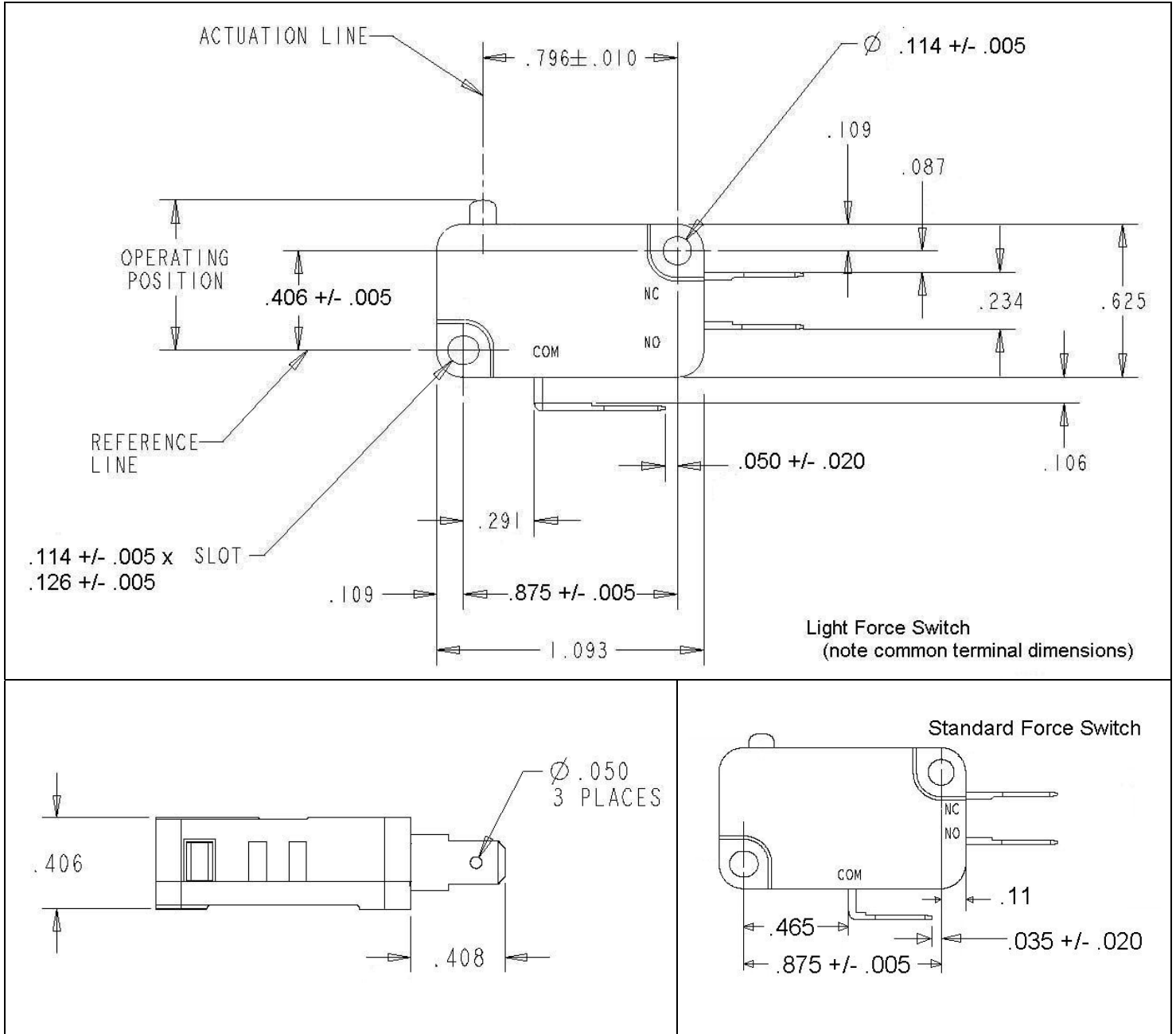

Common terminal dimensions valid for 0.187" QC terminals only



MINIATURE

E21-E36 Series

Actuators

Standard type integral hinged lever and roller actuators are available in choice of 2 mounting positions. Actuation lengths are dimensioned from the centerline of the switch mounting hole as shown.

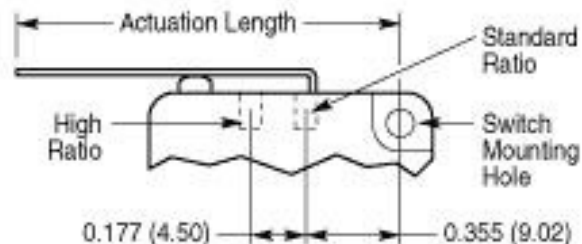

Plastic Actuator for -90N and -90NX switches	Plastic Actuator for -50N and -50NX switches
<p>Diagram illustrating the dimensions and labels for the plastic actuator for -90N and -90NX switches. The actuation length is 1.332 +/- .031. The operating position is .735 to .851. The actuation line is shown as a curved line with a radius of R .09.</p>	<p>Diagram illustrating the dimensions and labels for the plastic actuator for -50N and -50NX switches. The actuation length is 1.382. The operating position is .555 to .645. The actuation line is shown as a curved line. The reference line is shown as a dashed line. The common terminal (COM) is shown as a circular feature. The normally closed (NC) and normally open (NO) terminals are shown as rectangular features.</p>
Roller Actuator	Straight Leaf Actuator
<p>Diagram illustrating the dimensions and labels for the roller actuator. The dimensions 0.182" (Ref) and 0.187" (Ref) are shown as dimensions from the centerline of the switch mounting hole to the end of the lever.</p>	<p>Diagram illustrating the dimensions and labels for the straight leaf actuator. The dimensions .180 and .025 are shown as dimensions from the centerline of the switch mounting hole to the end of the lever.</p>

Note: Plastic levers only available on 85°C rated switches



MINIATURE

E21-E36 Series

Not recommended for new designs

Please review our D4 series

<http://switches-sensors.zf.com/us/product/miniature-d4/>

Actuator Specifications

Item Number	Actuator	UL Rating	Maximum Operating Force (grams)	Maximum Pretravel inches (mm)	Operating Point* inches (mm)	Minimum Overtravel inches (mm)	Max. Movement Differential inches (mm)	Actuation Length**
0E2100AX		0.1A, 125VAC (0.25A, 30VDC optional)	15	0.047 (1.19)	0.578 +/- 0.020 (14.68 +/- 0.51)	.050 (1.27)	0.010 (0.25)	N/A
0E2100K0		0.1A, 125VAC (0.25A, 30VDC optional)	75	0.047 (1.19)	0.806 +/- 0.030 (20.47 +/- 0.76)	0.040 (1.02)	0.010 (0.25)	0.810 (20.57)
0E2150H0		0.1A, 125VAC (0.25A, 30VDC optional)	35	0.125 (3.18)	0.600 +/- 0.045 (15.24 +/- 0.51)	0.085 (2.16)	0.030 (0.76)	1.40 (35.56)
0E2200AX		3A, 125/250VAC 1/10HP, 250VAC (0.1A, 125VDC optional)	15	0.047 (1.19)	0.578 +/- 0.020 (14.68 +/- 0.51)	.050 (1.27)	0.010 (0.25)	N/A
0E2200K0		3A, 125/250VAC 1/10HP, 250VAC (0.1A, 125VDC optional)	75	0.047 (1.19)	0.806 +/- 0.030 (20.47 +/- 0.76)	0.040 (1.02)	0.010 (0.25)	0.810 (20.57)
0E2250HX		3A, 125/250VAC 1/10HP, 250VAC (0.1A, 125VDC optional)	8	0.125 (3.18)	0.600 +/- 0.045 (15.24 +/- 0.51)	0.085 (2.16)	0.030 (0.76)	1.40 (35.56)
0E2250K0		3A, 125/250VAC 1/10HP, 250VAC (0.1A, 125VDC optional)	35	0.125 (3.18)	0.806 +/- 0.045 (20.47 +/- 1.14)	0.085 (2.16)	0.030 (0.76)	1.34 (34.04)
0E2250KL		3A, 125/250VAC 1/10HP, 250VAC (0.1A, 125VDC optional)	25	0.200 (5.08)	0.806 +/- 0.075 (20.47 +/- 1.91)	0.120 (3.05)	0.040 (1.02)	1.516 (38.51)
0E2255HX		3A, 125/250VAC 1/10HP, 250VAC (0.1A, 125VDC optional)	4	0.300 (7.62)	0.600 +/- 0.100 (15.24 +/- 2.54)	0.187 (4.75)	0.065 (1.65)	2.757 (70.03)
0E2285HX		3A, 125/250VAC 1/10HP, 250VAC (0.1A, 125VDC optional)	2	0.500 (12.70)	0.600 +/- 0.175 (15.24 +/- 4.45)	0.312 (7.92)	0.100 (2.54)	2.932 (74.47)
0E2300A0		5A, 1/4HP, 125/250VAC	170	0.047 (1.19)	0.578 +/- 0.020 (14.68 +/- 0.51)	.050 (1.27)	0.010 (0.25)	N/A
0E2300K0		5A, 1/4HP, 125/250VAC	170	0.047 (1.19)	0.806 +/- 0.030 (20.47 +/- 0.76)	0.040 (1.02)	0.010 (0.25)	0.810 (20.57)
0E2350H0		5A, 1/4HP, 125/250VAC	85	0.125 (3.18)	0.600 +/- 0.045 (15.24 +/- 0.51)	0.085 (2.16)	0.030 (0.76)	1.40 (35.56)
0E2350K0		5A, 1/4HP, 125/250VAC	86	0.125 (3.18)	0.806 +/- 0.045 (20.47 +/- 1.14)	0.085 (2.16)	0.030 (0.76)	1.34 (34.04)
0E2355HX		5A, 1/4HP, 125/250VAC	10	0.300 (7.62)	0.600 +/- 0.100 (15.24 +/- 2.54)	0.187 (4.75)	0.065 (1.65)	2.757 (70.03)
0E2385HX		5A, 1/4HP, 125/250VAC	6	0.500 (12.70)	0.600 +/- 0.175 (15.24 +/- 4.45)	0.312 (7.92)	0.100 (2.54)	2.932 (74.47)
0E3300A0		10A, 1/2HP, 125/250VAC (6A, 30VDC optional)	285	0.047 (1.19)	0.578 +/- 0.020 (14.68 +/- 0.51)	.050 (1.27)	0.010 (0.25)	N/A
0E3300AX		10A, 1/2HP, 125/250VAC (6A, 30VDC optional)	75	0.047 (1.19)	0.578 +/- 0.020 (14.68 +/- 0.51)	.050 (1.27)	0.010 (0.25)	N/A
0E3300K0		10A, 1/2HP, 125/250VAC (6A, 30VDC optional)	285	0.047 (1.19)	0.806 +/- 0.030 (20.47 +/- 0.76)	0.040 (1.02)	0.010 (0.25)	0.810 (20.57)
0E3350H0		10A, 1/2HP, 125/250VAC (6A, 30VDC optional)	144	0.125 (3.18)	0.600 +/- 0.045 (15.24 +/- 0.51)	0.085 (2.16)	0.030 (0.76)	1.40 (35.56)
0E3350HL		10A, 1/2HP, 125/250VAC (6A, 30VDC optional)	86	0.220 (5.59)	0.600 +/- 0.075 (15.24 +/- 1.91)	0.130 (3.30)	0.040 (1.02)	1.580 (40.13)
0E3350K0		10A, 1/2HP, 125/250VAC (6A, 30VDC optional)	144	0.125 (3.18)	0.806 +/- 0.045 (20.47 +/- 1.14)	0.085 (2.16)	0.030 (0.76)	1.34 (34.04)
0E3385HX		10A, 1/2HP, 125/250VAC (6A, 30VDC optional)	10	0.500 (12.70)	0.600 +/- 0.175 (15.24 +/- 4.45)	0.312 (7.92)	0.100 (2.54)	2.932 (74.47)
0E3400A0		15A, 1/2HP, 125/250VAC	400	0.047 (1.19)	0.578 +/- 0.020 (14.68 +/- 0.51)	.050 (1.27)	0.010 (0.25)	N/A
0E3400K0		15A, 1/2HP, 125/250VAC	400	0.047 (1.19)	0.806 +/- 0.030 (20.47 +/- 0.76)	0.040 (1.02)	0.010 (0.25)	0.810 (20.57)
0E3450HX		15A, 1/2HP, 125/250VAC	50	0.125 (3.18)	0.600 +/- 0.045 (15.24 +/- 0.51)	0.085 (2.16)	0.030 (0.76)	1.40 (35.56)
0E3450K0		15A, 1/2HP, 125/250VAC	200	0.125 (3.18)	0.806 +/- 0.045 (20.47 +/- 1.14)	0.085 (2.16)	0.030 (0.76)	1.34 (34.04)
0E3455HX		15A, 1/2HP, 125/250VAC	22	0.300 (7.62)	0.600 +/- 0.100 (15.24 +/- 2.54)	0.187 (4.75)	0.065 (1.65)	2.757 (70.03)
0E3485HX		15A, 1/2HP, 125/250VAC	13	0.500 (12.70)	0.600 +/- 0.175 (15.24 +/- 4.45)	0.312 (7.92)	0.100 (2.54)	2.932 (74.47)

* Measured above reference line. Refer to dimensional drawing.

** Actuator tolerance +/- 0.031" @ 0.787).

NOTE: E35 and E36 available in light force only.





MINIATURE

Not recommended for new designs
Please review our D4 series

<http://switches-sensors.zf.com/us/product/miniature-d4/>

E21-E36 Series

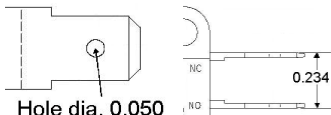
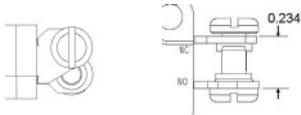
Terminals

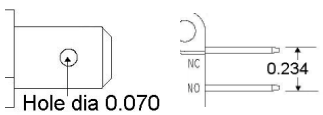
 <p>Hole dia. 0.050</p> <p>0.187 x 0.020 QC Terminals Suffix -00</p>	 <p>Screw Terminals (special order) Suffix -10</p>	 <p>Hole dia. 0.099</p> <p>Solder Terminals (special order) Suffix -20</p>	 <p>Hole dia 0.070</p> <p>0.250 x 0.032 QC Terminals Suffix -40</p>
--	---	--	--

Note: 0.187" Quick Connect terminals are standard i.e. part number E21-00A
To order 0.250" Quick Connect terminals 'add' the suffix to the part number, i.e. E21-40A

Circuitry

Terminal	Standard Force			Light Force		
	SPDT	SPST NO	SPST NC	SPDT	SPST NO	SPST NC
QC 0.187"	-00A	-01A	-02A	-00AX	-01AX	-02AX
Screw	-10A	-11A	-12A	-10AX	-11AX	-12AX
Solder	-20A	-21A	-22A	-20AX	-21AX	-22AX
QC 0.250"	-40A	-41A	-42A	-40AX	-41AX	-42AX

Note: 1. SPDT contact arrangement is standard. In general, normally open switches may be ordered by changing the suffix number from -00 to -01 and normally closed may be ordered by changing the suffix from -00 to -02. See above for assistance.
2. E35 and E36 only available as light force with 0.250" QC terminals.

Ordering Information

- Select the contact rating prefix you need (E21-E36).
- Combine the prefix with the corresponding terminal configuration. For example part number E21-00H will provide you with a gold crosspoint miniature switch with 0.187" QC terminals and a straight lever with a 0.865" actuation length
- To order a normally open version simply 'add 1' to the suffix to obtain E21-01H and normally closed 'add 2' for part number E21-02H.
- To order a E21-00H with .screw terminals, 'add' the new terminal code (-10) to the part number – E21-10H will be the resulting part number for a miniature switch with screw terminals and a straight lever with a 0.865" actuation length.

Contact

Call, fax or visit our
Website for more information.

ZF Electronics Corporation
11200 88th Avenue
Pleasant Prairie, WI 53158

The manufacturer accepts no
liability for errors or non-availability,
and reserves the right to change
specifications without prior notice.

Technical data relates to product

<http://switches-sensors.zf.com/us/product/miniature-d4/>

© 2007 ZF Electronics Corporation

Last Updated: 061212



X-ON Electronics

Largest Supplier of Electrical and Electronic Components

Click to view similar products for [Basic / Snap Action Switches](#) category:

Click to view products by [ZF Cherry](#) manufacturer:

Other Similar products are found below :

[83228001](#) [01.098.1358.1](#) [602EN1-6B](#) [602EN532](#) [602EN535-RB](#) [602HE5-RB1](#) [604HE162](#) [604HE223-6B](#) [624HE17-RB](#) [6HM89](#) [6PA78-JM](#)
[6SE1](#) [6SX1-H58](#) [70500840](#) [MBD5B1](#) [MBH2731](#) [73-316-0012](#) [79211759](#) [79211923](#) [79218589](#) [7AS12](#) [ML-1155](#) [ML-1376](#) [831010C3.0](#)
[831060C3.TL](#) [831090C2.EL](#) [83131904](#) [84212012](#) [8AS239](#) [8HM73-3](#) [903VB1-PG](#) [914CE1-6G](#) [PL-100](#) [11SM1077-H4](#) [11SM1077-H58](#)
[11SM1-TN107](#) [11SM405](#) [11SM703-T](#) [11SM8423-H2](#) [11SX37-T](#) [11SX48-H58](#) [11SX55-H58](#) [11SM2442-T](#) [11SM76-T](#) [11SM77-H58](#)
[11SM77-T](#) [11SM863-T](#) [11SM866](#) [11SX47-H58](#) [A7CN-1M-1-LEFT](#)