

HX13351-378-SQ 0.03GHz - 7.125GHz SPDT Switch

General Description

The HX13351-378-SQ, a single-pole double-throw (SPDT) antenna switch module, is designed to operate within a frequency range spanning from 0.03GHz to 7.125GHz. Utilizing advanced CMOS SOI technology, the HX13351-378-SQ boasts low insertion loss, high isolation, and maintains excellent linearity even at low supply voltages.

Notably, the HX13351-378-SQ does not require external DC blocking capacitors, provided that no DC voltage is applied to any RF path. This outstanding performance renders the HX13351-378-SQ an ideal candidate for wireless applications, encompassing WLAN, Bluetooth, and IEEE 802.11a/b/g/n/ac/ax/be transmit/receive functionalities.

The module is encapsulated in a compact 1mm x 1mm QFN package with a low profile of just 0.4mm, ensuring ease of integration. Furthermore, the product complies with RoHS standards and is free from halogen, ensuring environmental safety. The HX13351-378-SQ is rated at Moisture Sensitivity Level 1 (MSL1) at 260°C, adhering to JEDEC J-STD-020 specifications.

By leveraging its advanced technology, compact packaging, and robust performance, the HX13351-378-SQ antenna switch module is an excellent choice for a wide range of wireless applications.

Features

- Broadband Support: 0.03 - 7.125 GHz
- Low Control Voltage: 1.6 ~ 3.6 V
- WLAN Compatibility: Compatible with IEEE 802.11a/b/g/n/ac/ax/be Networks
- Advanced Technology: Advanced CMOS SOI Process
- Low Insertion Loss: Ensures Minimal Signal Degradation
- High Isolation: Prevents Crosstalk and Interference
- Excellent Linearity: Maintains Stable Performance
- RF Ports: 6 Symmetrical Ports
- No External DC Blocking: No External Capacitor Required Unless DC Applied
- Compact Size: Small QFN Package, 1mm x 1mm x 0.4mm, 6-pin
- Green Product: RoHS-Compliant and Halogen-Free

Applications

- Mobile Devices
- IEEE 802.11a/b/g/n/ac/ax/be WLAN Networks

PIN CONFIGURATIONS AND FUNCTIONS

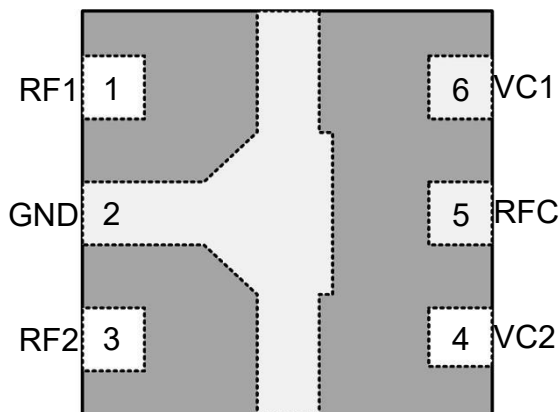

Pin Descriptio		
Pin	Name	Description
1	RF1	RF output 1
2	GND	Ground
3	RF2	RF output 2
4	VC2	DC control voltage 2
5	RFC	Antenna port
6	VC1	DC control voltage 1

Exposed Paddle: It must be connected to a ground through PCB via for best performance.

Block Diagram

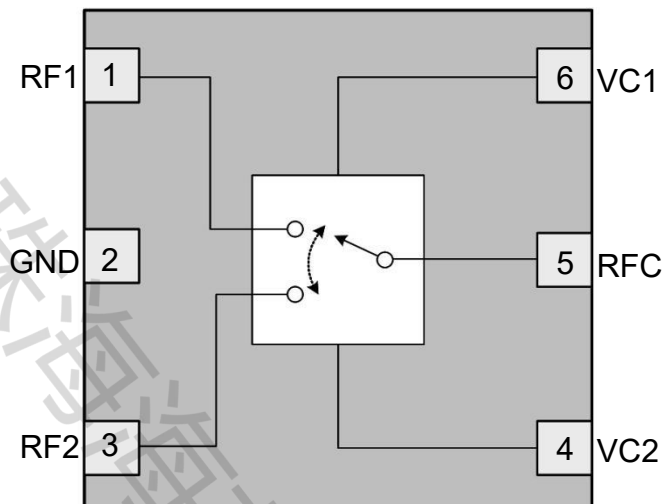

Absolute Maximum Ratings		
Parameter	Rating	Unit
Control Voltage(VC1,VC2)	5	V
RF Input Power	+32	dBm
Operating Temperature	-40 to 90	°C
Storage Temperature	-55 to 150	°C
ESD-Human Body Mode(HBM)	- 1.0 to 1.0	kV

Recommended Operating Conditions						
Parameter	Symbol	Condition	Minimum	Typical	Maximum	Unit
Supply Current	I _{DD}			27	50	μA
Control Voltage(VC1,VC2)	VC	High	1.6	1.8-3.3	3.6	V
		Low		0	0.3	

Logic Truth Table for Operation Modes			
State	MODE	VC1	VC2
1	RFC-RF1	0	1
2		1	1
3	RFC-RF2	1	0

"1"= 1.6~3.6V, "0"=0~0.3V

Note: Any operating mode other than described in this Table is not supported.

Characteristics at VC=3.3 V (Test Condition VC = 0V/3.3V, PIN = 0dBm, Tc = 25°C, 50Ω, unless otherwise specified)						
Parameter	Condition	Minimum	Typical	Maximum	Unit	
Frequency	IEEE 802. 1 1a/b/g/n/ac WLAN Networks	30		7125	MHz	
Insertion Loss	30MHz to 100MHz		0.10	0.25	dB	
	100MHz to 960MHz		0.11	0.30		
	1710MHz to 2170MHz		0.13	0.35		
	2170MHz to 2690MHz		0.16	0.40		
	3600MHz to 3800MHz		0.22	0.51		
	4800MHz to 5000MHz		0.26	0.64		
	5000MHz to 6000MHz		0.30	0.75		
	6000MHz to 7125MHz		0.33	0.80		
Isolation (RF1, 2 to RFC)	30MHz to 100MHz	56	61.3		dB	
	100MHz to 960MHz	36	41.1			
	1710MHz to 2170MHz	29	34.5			
	2170MHz to 2690MHz	27	32.7			
	3600MHz to 3800MHz	23	28.1			
	4800MHz to 5000MHz	21	26.1			
	5000MHz to 6000MHz	20	25.8			
Isolation (RF1 to RF2)	30MHz to 100MHz	56	61.3		dB	
	100MHz to 960MHz	36	41.1			
	1710MHz to 2170MHz	29	34.5			
	2170MHz to 2690MHz	27	32.7			
	3600MHz to 3800MHz	23	28.1			
	4800MHz to 5000MHz	21	26.1			
	5000MHz to 6000MHz	20	25.8			
Return Loss (Insertion loss state)	30MHz to 100MHz	29	39.1		dB	
	100MHz to 960MHz	29	36.8			
	1710MHz to 2170MHz	23	34.3			
	2170MHz to 2690MHz	18	28.5			
	3600MHz to 3800MHz	14	20.3			
	4800MHz to 5000MHz	12	19.6			
	5000MHz to 6000MHz	10	18.9			
Voltage Standing Wave Ratio (RFC to RF1, 2)	30MHz to 100MHz		1.02	1.20		
	100MHz to 960MHz		1.02	1.25		
	1710MHz to 2170MHz		1.03	1.30		
	2170MHz to 2690MHz		1.07	1.45		
	3600MHz to 3800MHz		1.21	1.60		
	4800MHz to 5000MHz		1.23	1.85		
	5000MHz to 6000MHz		1.25	1.95		
	6000MHz to 7125MHz		1.27	2.20		
Input Power for 0. 1dB Compression	@2.4GHz	31	32		dBm	
	@5.8GHz	31	32			
Input 3rd Order Distortion Intercept Point	PIN= +20 dBm/tone, Δf= 1 MHz, 2. 45 GHz			58	dBm	
Harmonics	2f0 1- 1	f=915MHz, Pin=+26dBm,CW	85	94	dBc	
	3f0 2- 1		85	90		
	2f0 1-2	f=2545MHz, Pin=+26dBm,CW	73	90	dBc	
	3f0 2-2		73	84		
Maximum Power (Pmax)	30MHz to 7125MHz		29	33	dBm	
Switching Rise/Fall Time	10/90% to 90/10% RF			200	400	ns
Switching On/Off Time	VC1=2.8V,VC2=0/2.8V (Logic Truth Table State 2 to 3, or 3 to 2)			200	400	ns
	VC1=0V,VC2=2.8V(Logic Truth Table State 1)			200	400	ns

Characteristics at VC=1.8 V						
(Test Condition VC = 0V/1.8V, PIN = 0dBm, Tc = 25°C, 50Ω, unless otherwise specified)						
Parameter	Condition	Minimum	Typical	Maximum	Unit	
Frequency	IEEE 802.11 a/b/g/n/ac WLAN Networks	30		7125	MHz	
Insertion Loss	30MHz to 100MHz		0.11	0.26	dB	
	100MHz to 960MHz		0.12	0.31		
	1710MHz to 2170MHz		0.16	0.38		
	2170MHz to 2690MHz		0.19	0.43		
	3600MHz to 3800MHz		0.23	0.52		
	4800MHz to 5000MHz		0.27	0.65		
	5000MHz to 6000MHz		0.32	0.77		
Isolation (RF1, 2 to RFC)	30MHz to 100MHz	56	60.5		dB	
	100MHz to 960MHz	36	40.7			
	1710MHz to 2170MHz	29	33.9			
	2170MHz to 2690MHz	27	31.8			
	3600MHz to 3800MHz	23	27.5			
	4800MHz to 5000MHz	21	25.2			
	5000MHz to 6000MHz	20	24.3			
Isolation (RF1 to RF2)	30MHz to 100MHz	56	60.5		dB	
	100MHz to 960MHz	36	40.7			
	1710MHz to 2170MHz	29	33.9			
	2170MHz to 2690MHz	27	31.8			
	3600MHz to 3800MHz	23	27.5			
	4800MHz to 5000MHz	21	25.2			
	5000MHz to 6000MHz	20	24.3			
Return Loss (Insertion loss state)	30MHz to 100MHz	29	38.7		dB	
	100MHz to 960MHz	29	36.6			
	1710MHz to 2170MHz	23	33.3			
	2170MHz to 2690MHz	18	26.7			
	3600MHz to 3800MHz	14	20.1			
	4800MHz to 5000MHz	12	18.9			
	5000MHz to 6000MHz	10	18.3			
Voltage Standing Wave Ratio (RFC to RF1, 2)	30MHz to 100MHz		1.02	1.20		
	100MHz to 960MHz		1.03	1.26		
	1710MHz to 2170MHz		1.04	1.31		
	2170MHz to 2690MHz		1.09	1.47		
	3600MHz to 3800MHz		1.21	1.60		
	4800MHz to 5000MHz		1.25	1.87		
	5000MHz to 6000MHz		1.27	1.97		
Input Power for 0.1dB Compression	@2.4GHz	31	32		dBm	
	@5.8GHz	31	32			
Input 3rd Order Distortion Intercept Point	PIN = +20 dBm/tone, Δf = 1 MHz, 2.45 GHz			59	dBm	
Harmonics	2f0 1-1	f=915MHz, Pin=+26dBm, CW	85	94	dBc	
	3f0 2-1		85	90		
	2f0 1-2	f=2545MHz, Pin=+26dBm, CW	73	90	dBc	
	3f0 2-2		73	84		
Maximum Power (Pmax)	30MHz to 7125MHz		29	33	dBm	
Switching Rise/Fall Time	10/90% to 90/10% RF			200	500	ns
Switching On/Off Time	VC1= 1.8V, VC2=0/1.8V Logic Truth Table State 2 to 3, or 3 to 2)			200	500	ns
	VC1=0V, VC2= 1.8V (Logic Truth Table State 1)			200	500	ns

Application Schematic

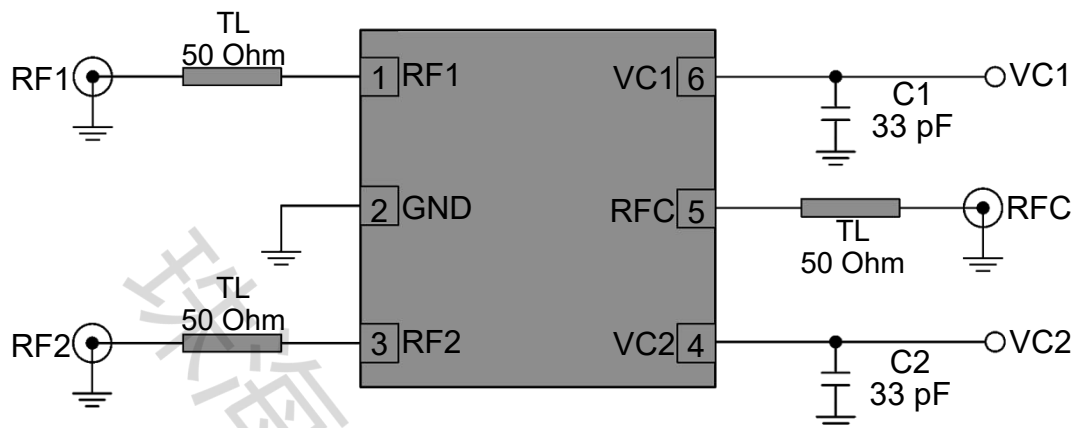

1. RF input and output are 50-Ohm microstrip.
2. Decoupling capacitors may be added for VC1/VC2 according to different applications.

Application Schematic

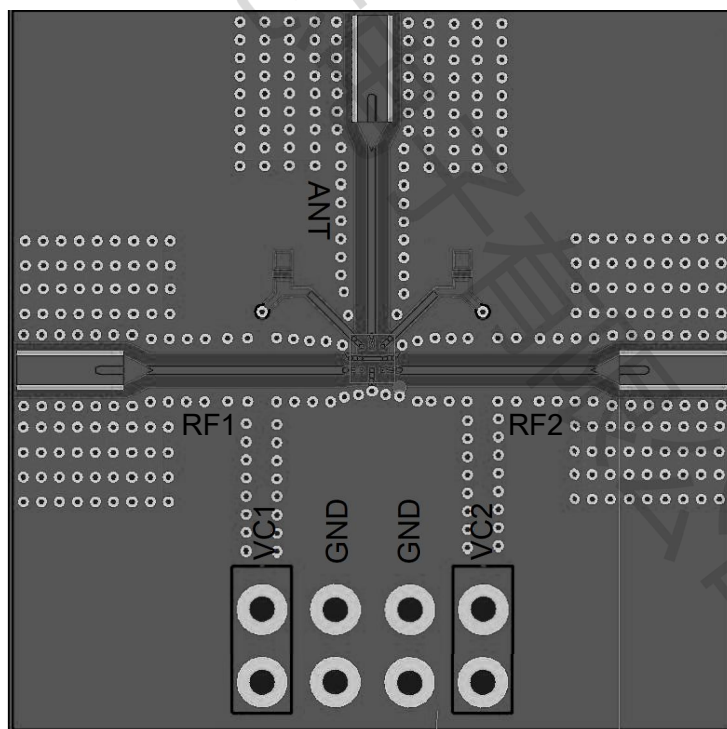

Notes for Evaluation Board

1. The copper pad on the bottom of the package should be soldered to the ground plane of the evaluation board.
2. The ground pad area should be big enough and there should be many the through vias on this ground pad, which are critical for thermal and RF performance.
3. The thickness of copper on both surface sides of the evaluation board is recommended to be 1 or 2 ounce.
4. Measurement data in this datasheet is based on an Rogers board with 1.2 mm thickness and 1 ounce copper on surface.

Package Dimensions

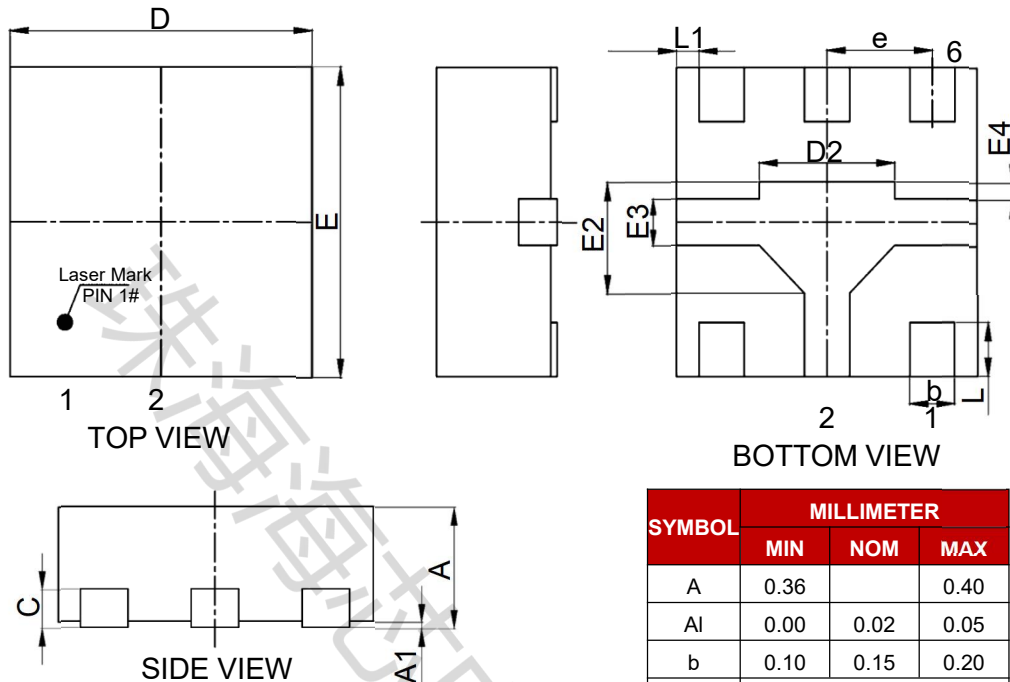

SYMBOL	MILLIMETER		
	MIN	NOM	MAX
A	0.36		0.40
A1	0.00	0.02	0.05
b	0.10	0.15	0.20
C	0.127REF		
D	0.95	1.00	1.05
D2	0.40	0.45	0.50
e	0.35BSC		
E	0.95	1.00	1.05
E2	0.31	0.36	0.41
E3	0.10	0.15	0.20
E4	0.005	0.055	0.105
L	0.125	0.175	0.225
L1	0.075REF		

Note:

1. All dimensions are measured in millimeters.
2. Drawing is not to scale.

Marking Specification

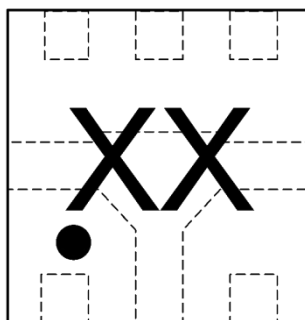

Line1: The character XX is a two-digit rolling code. The rolling code rule is 0-9(10 characters), a-z(24 characters, get rid of o and i), A-Z(24 characters, get rid of O and I), totally 58 characters, permutation and combination in the following order:

00,01 ...09, 0a,0b...0z,0A,0B...0Z

10,11...19,1a,1b...1z,1A,1B...1Z.....

Z0, Z1...Z9, Za, Zb...Zz, ZA ,ZB...ZZ, totally 3364 rolling code. Enter the next cycle after all rolling codes are used.

Packaging Information

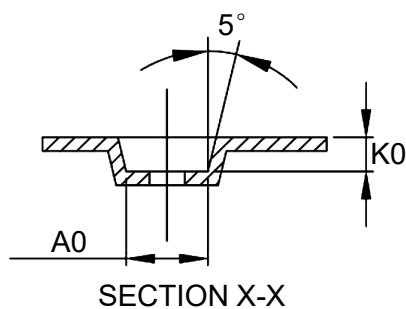
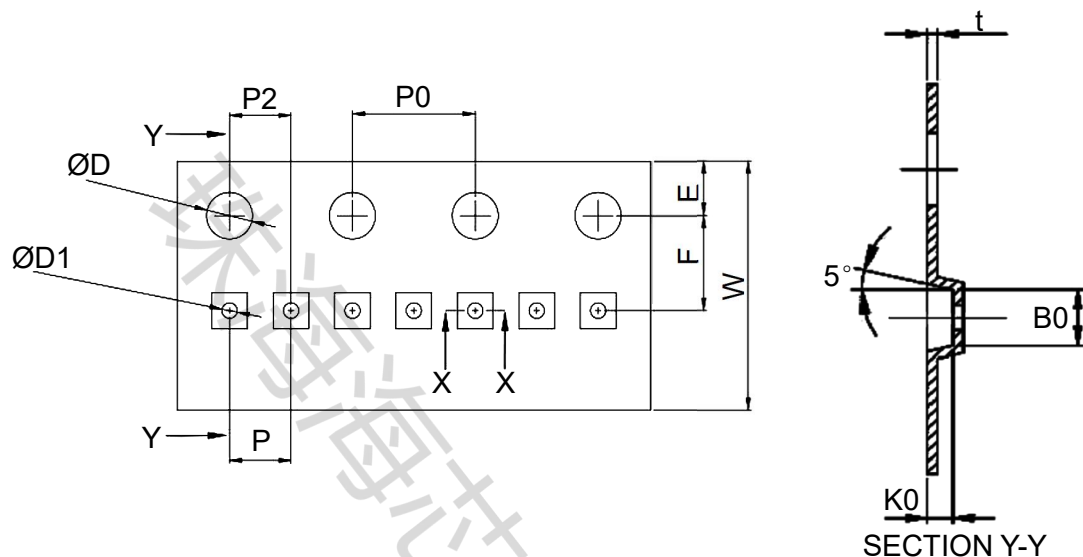

Common size	
SYMBOL	MILIMETER
E	1.75±0.10
F	3.50±0.05
P2	2.00±0.05
D	1.55±0.05
D1	0.50±0.05
P0	4.00±0.10
10P0	40.00±0.20

Pocket size	
W	8.0 ^{+0.3} _{-1.0}
P	2.00±0.05
A0	1.16±0.05
B0	1.16±0.05
K0	0.50±0.05
t	0.20±0.02

Package Type	Unit Size	Max Reel	Type Width	Pocket Pitch	Reel Capacity
Tape and Reel	1mm x 1mm x 0.4mm	7"	8mm	2mm	3000

Order Information

ORDER NUMBER	TEMPERATURE	PACKAGE DESCRIPTION	TYPE
HX13351-378-SQ	-40°C ~ 90°C	6-Pin, 1mm x 1mm x 0.4mm QFN Module Halogen Free	Tape & Reel, 3000 pcs per Reel

Disclaimer

All products due to improve reliability, function or design or for other reasons, product specifications and data are subject to change without notice.

Zhuhai Haixin Electronics Co., Ltd., branches, agents, employees, and all persons acting on its or their representatives (collectively, the "zhuhai Haixindianzi"), assumes no responsibility for any errors, inaccuracies or incomplete data contained in the table or any other any disclosure of any information related to the product. (www.haixindianzi.com)

Zhuhai Haixin makes no guarantee, representation or warranty on the product for any particular purpose of any goods or continuous production. To the maximum extent permitted by applicable law on Zhuhai Haixin relinquished: (1) any application and all liability arising out of or use of any products; (2) any and all liability, including but not limited to special, consequential damages or incidental ; (3) any and all implied warranties, including a particular purpose, non-infringement and merchantability guarantee.

Statement on certain types of applications are based on knowledge of the product is often used in a typical application of the general product Haixin Zhuhai demand that the Zhuhai Haixin of. Statement on whether the product is suitable for a particular application is non-binding. It is the customer's responsibility to verify specific product features in the products described in the specification is appropriate for use in a particular application. Parameter data sheets and technical specifications can be provided may vary depending on the application and performance over time. All operating parameters, including typical parameters must be made by customer's technical experts validated for each customer application. Product specifications do not expand or modify Zhuhai Haixin purchasing terms and conditions, including but not limited to warranty herein.

Unless expressly stated in writing, Zhuhai Haixin products are not intended for use in medical, life saving, or life sustaining applications or any other application. Wherein Haixin product failure could lead to personal injury or death, use or sale of products used in Zhuhai Haixin such applications using client did not express their own risk. Contact your authorized Zhuhai Haixin people who are related to product design applications and other terms and conditions in writing.

The information provided in this document and the company's products without a license, express or implied, by estoppel or otherwise, to any intellectual property rights granted to the Haixin act or document. Product names and trademarks referred to herein are trademarks of their respective representatives will be all.

X-ON Electronics

Largest Supplier of Electrical and Electronic Components

Click to view similar products for [RF Switch ICs](#) category:

Click to view products by [ZHHXDZ](#) manufacturer:

Other Similar products are found below :

[MASW-004100-11930W](#) [MASW-008853-TR3000](#) [MASW6010G](#) [BGSX210MA18E6327XTSA1](#) [CG2185X2](#) [CG2415M6](#) [MA4AGSW1A](#)
[MA4SW410](#) [MA4SW410B-1](#) [MASW-002102-13580G](#) [MASW-005100-11940W](#) [BGS 12PL6 E6327](#) [BGS1414MN20E6327XTSA1](#)
[BGS1515MN20E6327XTSA1](#) [SKY13374-397LF](#) [CG2415M6-C2](#) [AS222-92LF](#) [MASWSS0201TR](#) [MASW-007075-000100](#) [MASW-004103-13655P](#) [MASW-003102-13590G](#) [MASWSS0202TR-3000](#) [MA4SW310B-1](#) [MA4SW310](#) [SW-313-PIN](#) [CG2430X1](#) [SKY13405-490LF](#)
[SKYA21001](#) [SKY13415-485LF](#) [MMS008PP3](#) [SKY13319-374LF](#) [SKY13404-466LF](#) [SKY13473-569LF](#) [SKY13626-685LF](#) [NJG1809ME7-TE1](#) [SKY13343-92LF](#) [MASW-002103-13635P](#) [SKY13417-485LF](#) [MASW-004103-13650P](#) [NJG1649HB6](#) [RFASWE660DTF03](#)
[BGSA14GN10E6327](#) [FM1694C](#) [XMSS1R6G0PA-001](#) [AW13612FLR](#) [AW13102DNR](#) [FM3418C](#) [AW13508QNR](#) [FM8648M](#) [FM8545](#)