

HX7662-S/HX7662-P CMOS Voltage Converters

The HX7662-S/HX7662-P is a monolithic charge pump voltage inverter designed to convert a positive voltage in the range of +4.5V to +20V into the corresponding negative voltage of -4.5V to -20V. Compared to previous implementations of charge pump voltage inverters, the HX7662-S/HX7662-P offers superior performance by combining low quiescent current with high efficiency. It integrates an oscillator, control circuitry, and 4 power MOS switches on-chip, requiring only two low-cost capacitors as external components.

FEATURES

- +4.5V to +20V Supply to -4.5V to -20V Output
- Cascaded Voltage Multiplication ($V_{out} = -n \times V_{in}$)
- 99.7% Typical Open Circuit Conversion Efficiency
- Requires Only 2 External Capacitors
- Pin Compatible with the HX7661-S/HX7661-P

APPLICATIONS

- Inexpensive Negative Supplies
- Data Acquisition Systems
- Up to -20V for Op Amps, and Other Linear Circuits
- Supply Splitter, $V_{out} = V_s/2$ RS-232 Power Supplies

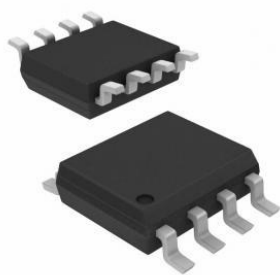

SOP-8

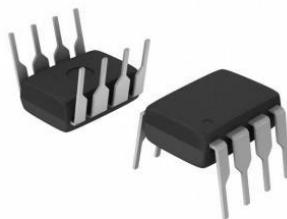

DIP-8

PIN ASSIGNMENT

TEST	1	●	8	V+
CAP+	2		7	OSC
GROUND	3		6	LV
CAP-	4		5	Vout

www.haixindianzi.com

ABSOLUTE MAXIMUM RATINGS		
Symbol	Limit	Unit
V+TO GND	-0.3 +22	V
Oscillator Input to GND(Note 1)		
V-<12V	-0.3 V++0.3	V
V+>12V	V+-12.3 V++0.3V	V
Power Dissipation (Note 2)		
Plastic DIP	300	mW
SO	500	mW
TO-99	500	mW
CERDIP	500	mW
Operating Temperature Ranges		
Commercial	0 to +70	°C
Extended	-40 to +85	°C
Military	-55 to +125	°C
Storage Temperature	-65 to +160	°C
Lead Temperature	+300	°C

ELECTRICAL CHARACTERISTICS						
PARAMETER	SYMBOL	CONDITIONS	MIN	TYP	MAX	UNITS
Supply Voltage Range-Lo	V+L	RL=10k Ω , LV=GND	55°C<TA<+125°C	4.5	11	V
Supply Voltage Range-Hi	V+H	RL=10k Ω , LV=Open	40°C<T <+85°C	9	20	
			55°C<T <+125°C	9	16.5	
Supply Current	I+	RL=0, LV=Open	TA=+25°C	0.25	0.60	mA
			0°C<TA<+70°C	0.30	0.85	
			55°C<TA<+125°C	0.40	1.0	
Output Source Resistance	Ro	Io =20mA, LV =Open	TA=+25°C	60	100	Ω
			0°C<TA<+70°C	70	120	
			55°C<TA<+125°C	90	150	
Supply Current	I+	V+=5V, RL=oo, LV=GND	TA=+25°C	20	150	μ A
			0°C<TA<+70°C	25	200	
			-55°C<TA<+125°C	30	250	
Output Source Resistance	Ro	V+=5V, Io =3mA, LV =GND	TA=+25°C	125	200	Ω
			0°C<TA<+70°C	150	250	
			-55°C<TA<+125°C	200	350	
Oscillator Frequency	fosc			10		kHz
Power Efficiency	Peff	RL=2k Ω	TA=+25°C	93	96	%
			Min<TA<Max	90	95	
Voltage Conversion Efficiency	VoEf	RL= ∞	Min<TA<Max	97	99.9	%
Oscillator Sink or Source Current	Iosc	V+=5V(Vosc =0V to +5V)			0.5	μ A
		V+=15V(Vosc=+5V to+15V)			4.0	

Notes

a. Connecting any terminal to voltages greater than V+or less than ground may cause destructive latchup. It is recommended that no input from sources operating from external supplies be applied prior to power-up of the HX7661-S/HX7661-P.

b. Derate linearly above +50°C by 5.5mW/°C

c. Pin 1 is a test pin and is not connected in normal use.

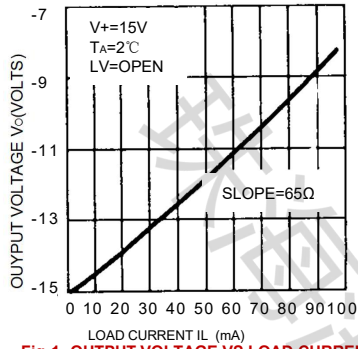

Fig 1. OUTPUT VOLTAGE VS. LOAD CURRENT

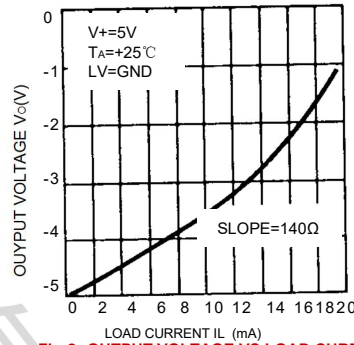

Fig 2. OUTPUT VOLTAGE VS. LOAD CURRENT

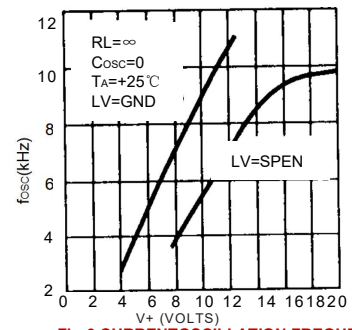

Fig 3. CURRENT OSCILLATION FREQUENCY VS. SUPPLY VOLTAGE

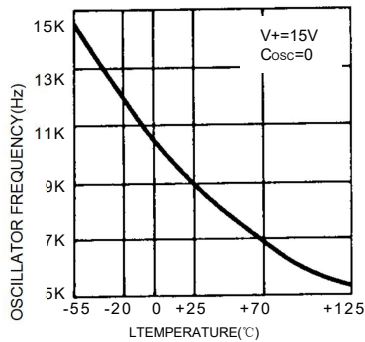

Fig 4. UNLOADED OSCILLATOR FREQUENCY vs. TEMPERATURE

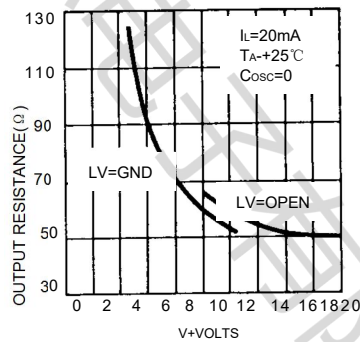

Fig 5. OUTPUT SOURCE RESLSTANCE vs. SUPPLY VOLTAGE

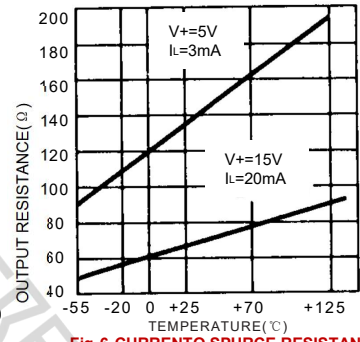

Fig 6. CURRENTO SPURCE RESISTANCE vs. TEMPERATURE

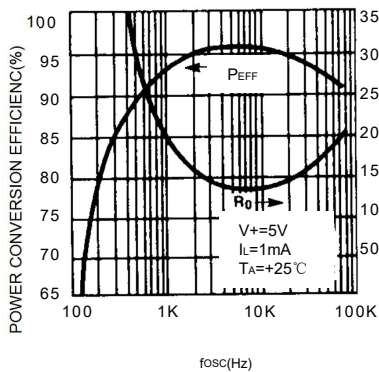

Fig 1. POWER CONVERSION FREQUENCY AND OUTPUT RESISTANCE vs. OSCILLATOR FREQUENCY

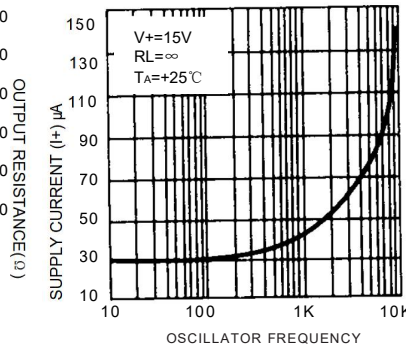

Fig 8. SUPPLY CURRENT vs. OSCILLATOR FREQUENCY

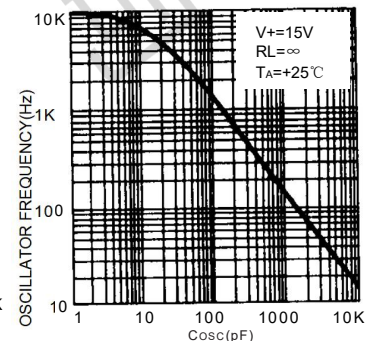
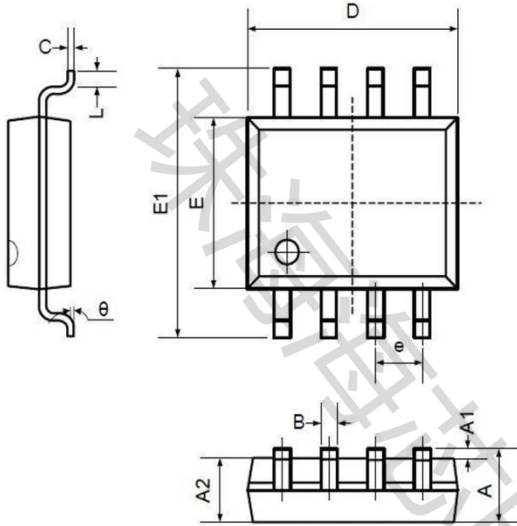

Fig 9. OSCILLATION FREQUENCY vs. EXTERNAL OSCILLATOR CAPACITANCE

Package Information

SOP8 (Package Outline Dimensions)



Symbol	Dimensions In Millimeters		Dimensions In Inches	
	Min	Max	Min	Max
A	1.350	1.750	0.053	0.069
A1	0.100	0.250	0.004	0.010
A2	1.350	1.550	0.053	0.061
B	0.330	0.510	0.013	0.020
C	0.190	0.250	0.007	0.010
D	4.780	5.000	0.188	0.197
E	3.800	4.000	0.150	0.157
E1	5.800	6.300	0.228	0.248
e	1.270TYP		0.050TYP	
L	0.400	1.270	0.016	0.050
theta	0°	8°	0°	8°

DIP8 (Package Outline Dimensions)

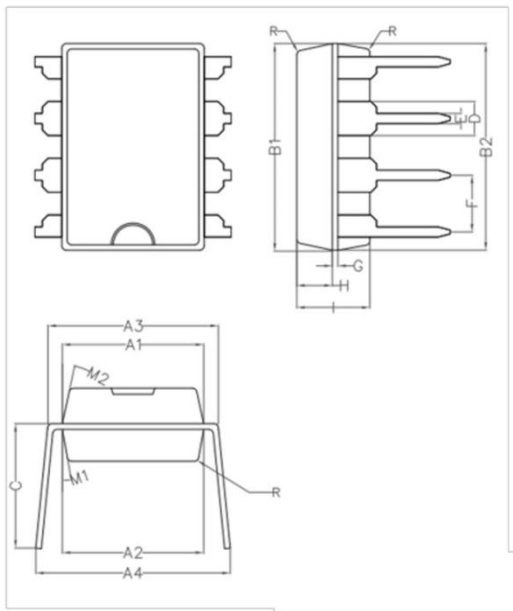

Symbol	Min	Non	Max
A1	6.28	6.33	6.38
A2	6.33	6.38	6.43
A3	7.52	7.62	7.72
A4	7.80	8.40	9.00
B1	9.15	9.20	9.25
B2	9.20	9.25	9.30
C		5.57	
D		1.52	
E	0.43	0.45	0.47
F		2.54	
G		0.25	
H	1.54	1.59	1.64
I	3.22	3.27	3.32
R		0.20	
M1	9°	10°	11°
M2	11°	12°	13°

Disclaimer

All products due to improve reliability, function or design or for other reasons, product specifications and data are subject to change without notice.

Zhuhai Haixin Electronics Co., Ltd., branches, agents, employees, and all persons acting on its or their representatives (collectively, the "Zhuhai Haixindianzi"), assumes no responsibility for any errors, inaccuracies or incomplete data contained in the table or any other any disclosure of any information related to the product.(www.haixindianzi.com)

Zhuhai Haixin makes no guarantee, representation or warranty on the product for any particular purpose of any goods or continuous production. To the maximum extent permitted by applicable law on Zhuhai Haixin relinquished: (1) any application and all liability arising out of or use of any products; (2) any and all liability, including but not limited to special, consequential damages or incidental ; (3) any and all implied warranties, including a particular purpose, non-infringement and merchantability guarantee.

Statement on certain types of applications are based on knowledge of the product is often used in a typical application of the general product Haixin Zhuhai demand that the Zhuhai Haixin of. Statement on whether the product is suitable for a particular application is non-binding. It is the customer's responsibility to verify specific product features in the products described in the specification is appropriate for use in a particular application. Parameter data sheets and technical specifications can be provided may vary depending on the application and performance over time. All operating parameters, including typical parameters must be made by customer's technical experts validated for each customer application. Product specifications do not expand or modify Zhuhai Haixin purchasing terms and conditions, including but not limited to warranty herein.

Unless expressly stated in writing, Zhuhai Haixin products are not intended for use in medical, life saving, or life sustaining applications or any other application. Wherein Haixin product failure could lead to personal injury or death, use or sale of products used in Zhuhai Haixin such applications using client did not express their own risk. Contact your authorized Zhuhai Haixin people who are related to product design applications and other terms and conditions in writing.

The information provided in this document and the company's products without a license, express or implied, by estoppel or otherwise, to any intellectual property rights granted to the Haixin act or document. Product names and trademarks referred to herein are trademarks of their respective representatives will be all.

X-ON Electronics

Largest Supplier of Electrical and Electronic Components

Click to view similar products for [Isolated DC/DC Converters](#) category:

Click to view products by [ZHHXDZ](#) manufacturer:

Other Similar products are found below :

[PSL486-7LR](#) [Q48T30020-NBB0](#) [JAHW100Y1](#) [SPB05C-12](#) [SQ24S15033-PS0S](#) [CE-1003](#) [CE-1004](#) [MAU228](#) [J80-0041NL](#) [DFC15U48D15](#)
[XGS-1205](#) [06322](#) [SPB05B-15](#) [L-DA20](#) [DCG40-5G](#) [XKS-2405](#) [DPA423R](#) [vi-m13-cw-03](#) [VI-L53-CV](#) [24IBX15-50-0ZG](#) [HZZ01204-G](#)
[SPU02L-09](#) [SPU02M-09](#) [SPU02N-09](#) [QUINT4-BUFFER/24DC/40](#) [QUINT4-CAP/24DC/5/4KJ](#) [73-551-5039I](#) [DFC15U48D15G](#) [SEN-6471-](#)
[1EM](#) [AHV2815DF/HBB](#) [MI-LC21-IX](#) [PAH-48/8.5-D48NB1-C](#) [BM3020-7A](#) [QRS2050P025K00](#) [CM2320-9EG](#) [SKMW15F-05](#)
[V300A28H400BF3](#) [TEN 15-1223](#) [TEQ 100-2418WIR](#) [TEQ 160-7218WIR](#) [R05C05TE05S-R](#) [HQA2W085W033V-N07-S](#) [AM1SS-2405SJZ](#)
[AM2DS-1224SJZ](#) [AM2DS-2405DJZ](#) [AM10SBO-4824SNZ-B](#) [AM15E-2405S-NZ](#) [AM2DS-1212SJZ](#) [AM30SBO-4805SNZ-B](#)
[LT8301ES5#WTRPBF](#)