

HX8617-S

Micro-Power 1.5MHz, Low-Noise, RRIO, 1.8V CMOS Amplifiers

General Description

The HX8617-S family of operational amplifiers, including single-, dual-, and quad-channel options, is specifically designed for cost-sensitive systems and applications. These amplifiers feature rail-to-rail input and output swings, low quiescent current (typically 50 μA), wide bandwidth (1.5 MHz), and very low noise (22 $\text{nV}/\sqrt{\text{Hz}}$ at 1 kHz), making them highly suitable for battery-powered applications that require a balance between cost and performance. Examples of such applications include audio outputs, consumer electronics, smoke detectors, portable medical devices, and white goods. The low input bias current allows these amplifiers to be used with high impedance sources.

The robust design of the HX8617-S amplifiers offers ease-of-use for circuit designers, with unity-gain stability even with capacitive loads up to 500 pF, integrated RF/EMI rejection filter, no phase reversal in overdrive conditions, and high electro-static discharge (ESD) protection (5-kV HBM).

The HX8617-S amplifiers are optimized for operation at voltages ranging from +1.8 V (± 0.9 V) to +5.5 V (± 2.75 V) within a temperature range of 0 $^{\circ}\text{C}$ to 70 $^{\circ}\text{C}$. They can also operate at voltages from +2.0 V (± 1.0 V) to +5.5 V (± 2.75 V) over an extended temperature range of -40 $^{\circ}\text{C}$ to +125 $^{\circ}\text{C}$.

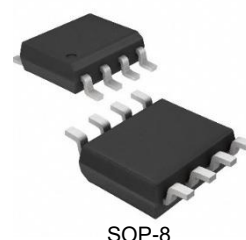

SOP-8

Features

- Rail-to-Rail Input and Output
- Low Input Offset Voltage: 0.5 mV
- Precision Amplifiers for Cost-Sensitive Systems
- Single 1.8 V to 5.5 V Supply Voltage Range at 0 $^{\circ}\text{C}$ to 70 $^{\circ}\text{C}$
- Extended Temperature Range: -40 $^{\circ}\text{C}$ to +125 $^{\circ}\text{C}$
- Low Noise: 22 $\text{nV}/\sqrt{\text{Hz}}$ at 1 kHz
- Micro-Power: 50 μA Supply Current Per Amplifier
- Internal RF/EMI Filter
- 1.5 MHz GBW for Unity-Gain Stable

Applications

- Sensor Signal Conditioning
Sensor Interfaces, Loop-Powered, Active Filters
- Wireless Sensors
Home Security, Remote Sensing, Wireless Metering
- Battery-Powered Instruments
Consumer, Industrial, Medical, Notebooks
- Audio Outputs

PIN CONFIGURATIONS

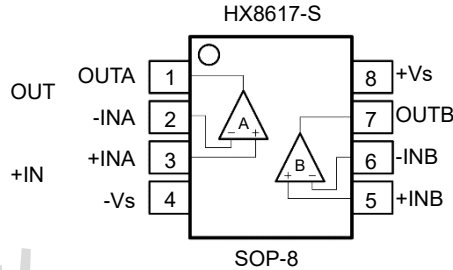

Pin Description	
Symbol	Description
-IN	Inverting input of the amplifier. The voltage range is from $(V_{S-} - 0.1V)$ to $(V_{S+} + 0.1V)$.
+IN	Non-inverting input of the amplifier. This pin has the same voltage range as -IN.
+Vs	Positive power supply.
-Vs	Negative power supply.
OUT	Amplifier output.

Limiting Value	
Parameter	Absolute Maximum Rating
Supply Voltage, V_{S+} to V_{S-}	10.0 V
Signal Input Terminals: Voltage, Current	$V_{S-} - 0.5 V$ to $V_{S+} + 0.5 V$, $\pm 10 mA$
Output Short-Circuit	Continuous
Storage Temperature Range, T_{stg}	$-65\text{ }^{\circ}C$ to $+150\text{ }^{\circ}C$
Junction Temperature, T_J	150 $^{\circ}C$
Lead Temperature Range (Soldering 10 sec)	260 $^{\circ}C$

Electrical Characteristics						
Symbol	Parameter	Conditions	Min.	Typ.	Max.	Unit
OFFSET VOLTAGE						
V_{os}	Input offset voltage			± 0.5	± 2.5	mV
		$T_A = -40$ to $+125\text{ }^{\circ}C$			± 2.8	
$V_{os TC}$	Offset voltage drift	$T_A = -40$ to $+125\text{ }^{\circ}C$		± 1	3	$\mu V/^{\circ}C$
P_{SRR}	Power supply rejection ratio	$V_S = 2.0$ to $5.5 V$, $V_{CM} < V_{S+} - 2V$	80	110		dB
		$T_A = -40$ to $+125\text{ }^{\circ}C$	75			
INPUT BIAS CURRENT						
I_b	Input bias current			1		pA
		$T_A = +85$		150		
		$T_A = +125\text{ }^{\circ}C$		500		

I _{os}	Input offset current			1		
NOISE						
V _n	Input voltage noise	f = 0.1 to 10 Hz		5.6		μVP-P
e _n	Input voltage noise density	f = 10 kHz		22		nV/√Hz
		f = 1 kHz		22		
I _n	Input current noise density					
INPUT VOLTAGE						
V _{CM}	Common-mode voltage range		V _S -0.1		V _S +0.1	V
CMRR	Common-mode rejection ratio	V _S = 5.5 V, V _{CM} = -0.1 to 5.6 V	70	83		dB
		V _{CM} = 0 to 5.3 V, T _A = -40 to +125°C	65			
		V _S = 2.0 V, V _{CM} = -0.1 to 2.1 V	65	77		
		V _{CM} = 0 to 1.8 V, T _A = -40 to +125°C	60			
INPUT IMPEDANCE						
C _{IN}	Input capacitance	Differential		2.0		pF
		Common mode		3.5		
OPEN-LOOP						
A _{VOL}	Open-loop voltage AVOL gain	R _L = 25 kΩ, V _O = 0.05 to 3.5 V	90	105		dB
		T _A = -40 to +125°C	85			
		R _L = 2 kΩ, V _O = 0.15 to 3.5 V	85	100		
		T _A = -40 to +125°C	80			
FREQUENCY RESPONSE						
GBW	Gain bandwidth product			1.5		MHz
SR	Slew rate	G = +1, C _L = 100 pF, V _O = 1.5 to 3.5 V		1.2		V/μs
THD+N	Total harmonic distortion+noise	G = +1, f = 1 kHz, V _O = 1V _{RMS}		0.002		%
t _s	Settling time	To 0.1%, G = +1, 1V step		1.2		μs
		To 0.01%, G = +1, 1V step		1.5		
t _{OR}	Overload recovery time	To 0.1%, V _{IN} * Gain > V _S		2		
OUTPUT						
V _{OH}	High output voltage swing	R _L = 25 kΩ	V _S +9	V _S +5		mV
		R _L = 2 kΩ	V _S +95	V _S +63		
V _{OL}	Low output voltage swing	R _L = 25 kΩ		V _S +3.5	V _S +6	mV
		R _L = 2 kΩ		V _S +43	V _S +65	
POWER SUPPLY						
V _S	Operating supply voltage	T _A = 0 to +70°C	1.8	5.5		V
		T _A = -40 to +125°C	2.0	5.5		
I _Q	Quiescent current(peramplifier)			75	125	μA
		T _A = -40 to +125°C			160	
THERMAL CHARACTERISTICS						
T _A	Operating temperature range		-40		+125	°C
θ _{JA}	Package Thermal Resistance	SOT23-5L		190		°C/W
		SOP-8		125		
		SOP-14		115		

Note

V_S = 5.0V, T_A = +25°C, V_{CM} = V_S / 2, V_O = V_S / 2, and R_L = 10kΩ connected to V_S / 2, unless otherwise noted.

TYPICAL PERFORMANCE CHARACTERISTICS

At TA = +25°C, VCM = VS / 2, and RL = 10kΩ connected to VS / 2, unless otherwise noted.

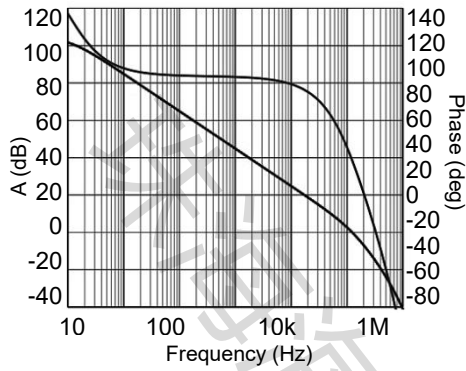

Open-loop Gain and Phase as a function of Frequency.

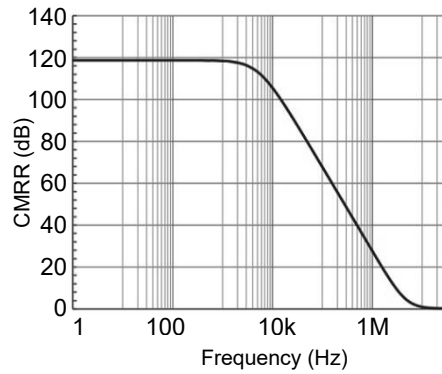

Common-mode Rejection Ratio as a function of Frequency.

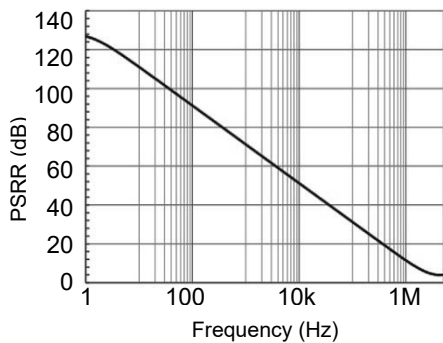

Power Supply Rejection Ratio as a function of Frequency.

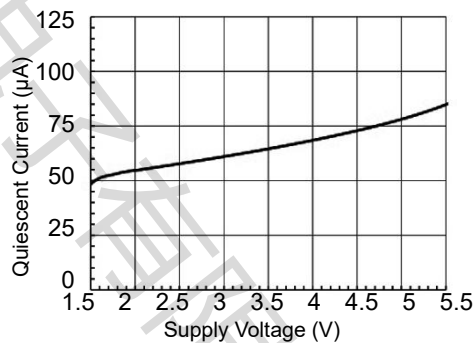

Quiescent Current as a function of Supply Voltage.

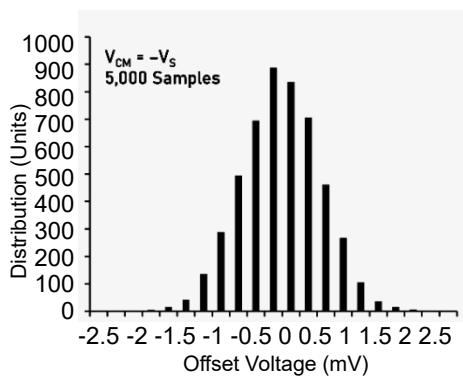

Offset Voltage Production Distribution

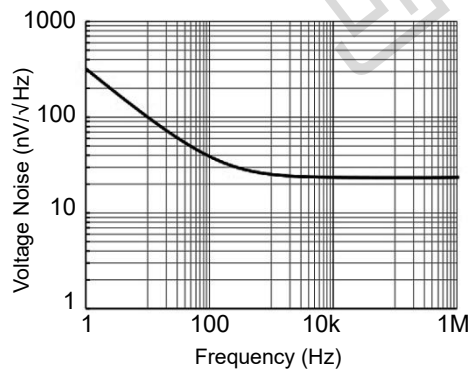

Input Voltage Noise Spectral Density as a function of Frequency.

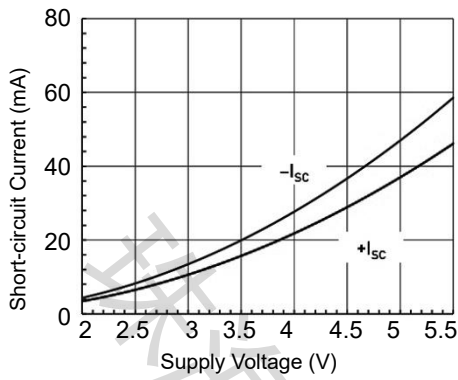

Short-circuit Current as a function of Supply Voltage.

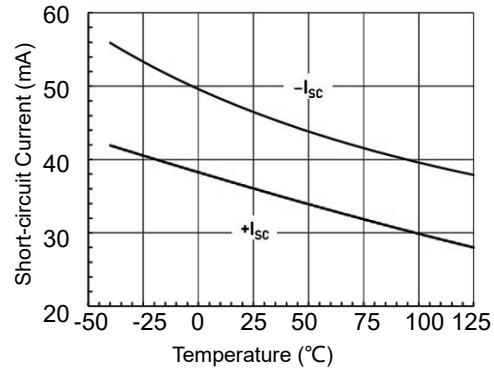

Short-circuit Current as a function of Temperature.

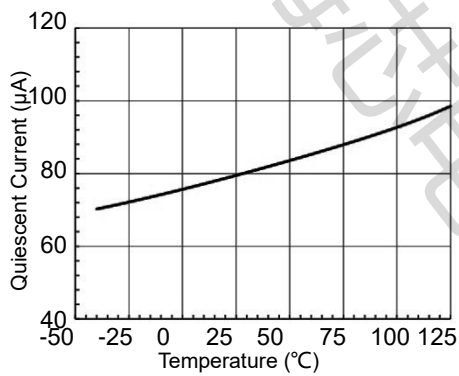

Quiescent Current as a function of Temperature.

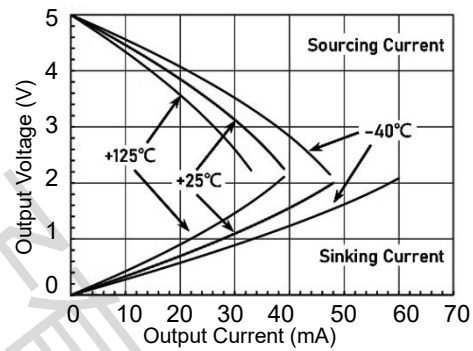

Output Voltage Swing as a function of Output Current.

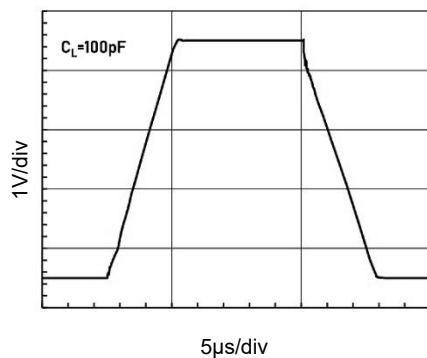

Large Signal Step Response.

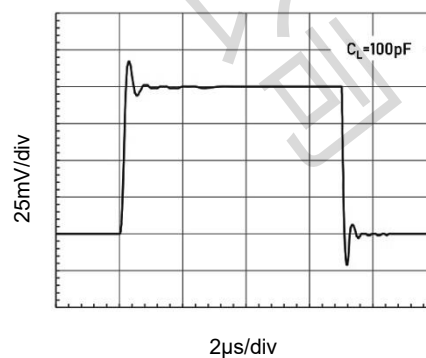

Small Signal Step Response.

SOP-8 (Package Outline Dimensions)

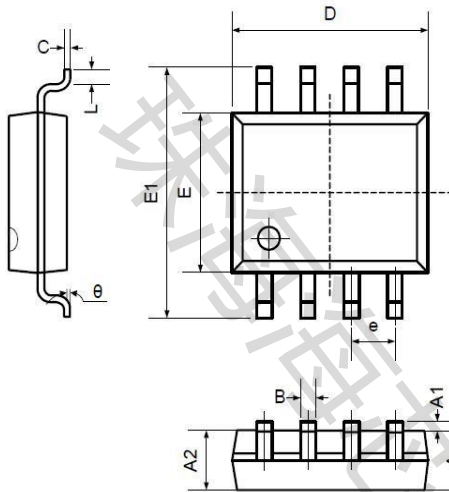

Symbol	Dimensions In Millimeters		Dimensions In Inches	
	Min	Max	Min	Max
A	1.350	1.750	0.053	0.069
A1	0.100	0.250	0.004	0.010
A2	1.350	1.550	0.053	0.061
B	0.330	0.510	0.013	0.020
C	0.190	0.250	0.007	0.010
D	4.780	5.000	0.188	0.197
E	3.800	4.000	0.150	0.157
E1	5.800	6.300	0.228	0.248
e	1.270TYP		0.050TYP	
L	0.400	1.270	0.016	0.050
θ	0°	8°	0°	8°

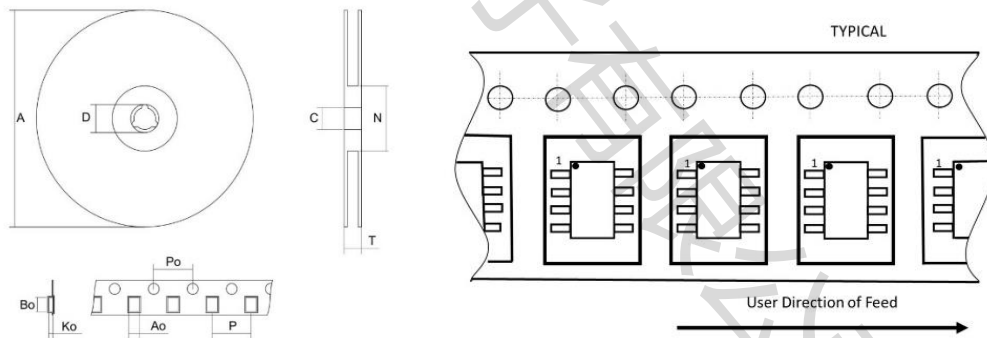

Part Number	Package Type	package	quantity
HX8617-S	SOP-8	Taping	2500

Disclaimer

All products due to improve reliability, function or design or for other reasons, product specifications and data are subject to change without notice.

Zhuhai Haixin Electronics Co., Ltd., branches, agents, employees, and all persons acting on its or their representatives (collectively, the "zhuhai Haixindianzi"), assumes no responsibility for any errors, inaccuracies or incomplete data contained in the table or any other any disclosure of any information related to the product. (www.haixindianzi.com)

Zhuhai Haixin makes no guarantee, representation or warranty on the product for any particular purpose of any goods or continuous production. To the maximum extent permitted by applicable law on Zhuhai Haixin relinquished: (1) any application and all liability arising out of or use of any products; (2) any and all liability, including but not limited to special, consequential damages or incidental ; (3) any and all implied warranties, including a particular purpose, non-infringement and merchantability guarantee.

Statement on certain types of applications are based on knowledge of the product is often used in a typical application of the general product Haixin Zhuhai demand that the Zhuhai Haixin of. Statement on whether the product is suitable for a particular application is non-binding. It is the customer's responsibility to verify specific product features in the products described in the specification is appropriate for use in a particular application. Parameter data sheets and technical specifications can be provided may vary depending on the application and performance over time. All operating parameters, including typical parameters must be made by customer's technical experts validated for each customer application. Product specifications do not expand or modify Zhuhai Haixin purchasing terms and conditions, including but not limited to warranty herein.

Unless expressly stated in writing, Zhuhai Haixin products are not intended for use in medical, life saving, or life sustaining applications or any other application. Wherein Haixin product failure could lead to personal injury or death, use or sale of products used in Zhuhai Haixin such applications using client did not express their own risk. Contact your authorized Zhuhai Haixin people who are related to product design applications and other terms and conditions in writing.

The information provided in this document and the company's products without a license, express or implied, by estoppel or otherwise, to any intellectual property rights granted to the Haixin act or document. Product names and trademarks referred to herein are trademarks of their respective representatives will be all.

X-ON Electronics

Largest Supplier of Electrical and Electronic Components

Click to view similar products for [Operational Amplifiers - Op Amps](#) category:

Click to view products by [ZHHXDZ](#) manufacturer:

Other Similar products are found below :

[430227FB](#) [LT1678IS8](#) [058184EB](#) [NCV33202DMR2G](#) [NJM324E](#) [M38510/13101BPA](#) [NTE925](#) [AZV358MTR-G1](#) [AP4310AUMTR-AG1](#)
[AZV358MMTR-G1](#) [SCY33178DR2G](#) [NCV20034DR2G](#) [NTE778S](#) [NTE871](#) [NTE937](#) [NJU7057RB1-TE2](#) [SCY6358ADR2G](#)
[NJM2904CRB1-TE1](#) [UPC4570G2-E1-A](#) [UPC4741G2-E1-A](#) [UPC4574GR-9LG-E1-A](#) [NJM8532RB1-TE1](#) [EL2250CS](#) [EL5100IS](#) [EL5104IS](#)
[EL5127CY](#) [EL5127CYZ](#) [EL5133IW](#) [EL5152IS](#) [EL5156IS](#) [EL5162IS](#) [EL5202IY](#) [EL5203IY](#) [EL5204IY](#) [EL5210CS](#) [EL5210CYZ](#)
[EL5211IYE](#) [EL5220CY](#) [EL5223CLZ](#) [EL5223CR](#) [EL5224ILZ](#) [EL5227CLZ](#) [EL5227CRZ](#) [EL5244CS](#) [EL5246CS](#) [EL5246CSZ](#) [EL5250IY](#)
[EL5251IS](#) [EL5257IS](#) [EL5260IY](#)