



SMFxx(C)A Series

Surface Mount Transient Voltage Suppressor Rectifiers

Reverse Voltage 5.0 ~ 440 V

225 Watt Peak Pulse Power

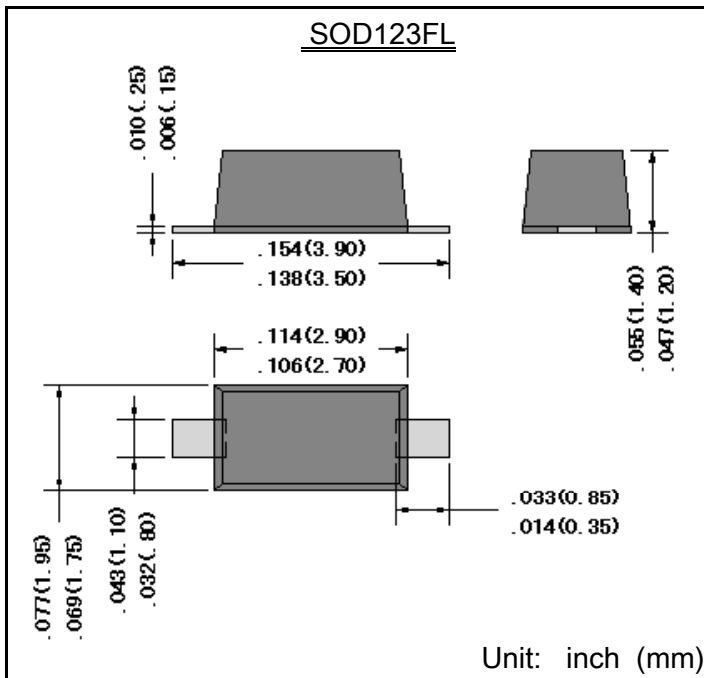

Features

- Glass passivated chip
- 225 W peak pulse power capability with a 10/1000 us waveform, repetitive rate (duty cycle):0.01 %
- Excellent clamping capability
- Low reverse leakage
- Very fast response time
- Lead and body according with RoHS standard

Mechanical Data

- Case: SOD123FL Molded plastic
- Lead: Solderable per MIL-STD-750, method 2026
- Epoxy: UL 94V-0 rate flame retardant
- Polarity: Color band denotes cathode end except Bipolar
- Mounting position: Any

Maximum Ratings & Characteristics Ratings at 25°C ambient temperature unless otherwise specified.

Parameter	Symbols	Value	Unit
Peak power dissipation with a 10/1000 us waveform ⁽¹⁾	P_{PP}	225	W
Peak pulse current with a 10/1000 us waveform ⁽¹⁾	I_{PP}	See Next Table	A
Power dissipation on infinite heatsink at $T_L = 75\text{ }^\circ\text{C}$	P_D	1.0	W
Peak forward surge current, 8.3 ms single half sine wave unidirectional only ⁽²⁾	I_{FSM}	30	A
Maximum instantaneous forward voltage at 10 A for unidirectional only ⁽³⁾	V_F	3.5/6.5	V
Operating junction and storage temperature range	T_J, T_{STG}	-55 to +150	°C

Note:

1) Non-repetitive current pulse per Fig.5 and derated above $T_A = 25\text{ }^\circ\text{C}$ per Fig.1 ;

2) Measured on 8.3 ms single half sine-wave or equivalent square wave, duty cycle = 4 pulses per minute maximum ;

3) $V_F < 3.5\text{ V}$ for devices of $V_{BR} < 200\text{ V}$ and $V_F < 6.5\text{ V}$ for devices of $V_{BR} > 201\text{ V}$.



SMFxx(C)A Series

Part Number		Device Marking Code		Reverse Stand-off Voltage	Breakdown Voltage $V_{BR} @ I_T$		Test Current	Max. Clamping Voltage @ I_{PP}	Max. Peak Pulse Current	Max. Reverse Leakage @ V_{RWM}
UNI-POLAR	BI-POLAR	UNI	BI	$V_{RWM}(V)$	Min.(V)	Max.(V)	$I_T(mA)$	$V_{C MAX.}(V)$	$I_{PP}(A)$	$I_R(\mu A)$
SMF5.0A	SMF5.0CA	KE	AE	5.0	6.40	7.00	10	9.2	24.5	800
SMF6.0A	SMF6.0CA	KG	AG	6.0	6.67	7.37	10	10.3	21.8	800
SMF6.5A	SMF6.5CA	KK	AK	6.5	7.22	7.98	10	11.2	20.1	500
SMF7.0A	SMF7.0CA	KM	AM	7.0	7.78	8.60	10	12.0	18.8	200
SMF7.5A	SMF7.5CA	KP	AP	7.5	8.33	9.21	1	12.9	17.4	100
SMF8.0A	SMF8.0CA	KR	AR	8.0	8.89	9.83	1	13.6	16.5	50
SMF8.5A	SMF8.5CA	KT	AT	8.5	9.44	10.40	1	14.4	15.6	20
SMF9.0A	SMF9.0CA	KV	AV	9.0	10.00	11.10	1	15.4	14.6	10
SMF10A	SMF10CA	KX	AX	10.0	11.10	12.30	1	17.0	13.2	5
SMF11A	SMF11CA	KZ	AZ	11.0	12.20	13.50	1	18.2	12.4	1
SMF12A	SMF12CA	LE	BE	12.0	13.30	14.70	1	19.9	11.3	1
SMF13A	SMF13CA	LG	BG	13.0	14.40	15.90	1	21.5	10.5	1
SMF14A	SMF14CA	LK	BK	14.0	15.60	17.20	1	23.2	9.7	1
SMF15A	SMF15CA	LM	BM	15.0	16.70	18.50	1	24.4	9.23	1
SMF16A	SMF16CA	LP	BP	16.0	17.80	19.70	1	26.0	8.65	1
SMF17A	SMF17CA	LR	BR	17.0	18.90	20.90	1	27.6	8.15	1
SMF18A	SMF18CA	LT	BT	18.0	20.00	22.10	1	29.2	7.71	1
SMF20A	SMF20CA	LV	BV	20.0	22.20	24.50	1	32.4	6.94	1
SMF22A	SMF22CA	LX	BX	22.0	24.40	26.90	1	35.5	6.30	1
SMF24A	SMF24CA	LZ	BZ	24.0	26.70	29.50	1	38.9	5.74	1
SMF26A	SMF26CA	ME	CE	26.0	28.90	31.90	1	42.1	5.29	1
SMF28A	SMF28CA	MG	CG	28.0	31.10	34.40	1	45.4	4.95	1
SMF30A	SMF30CA	MK	CK	30.0	33.50	36.80	1	48.4	4.61	1
SMF33A	SMF33CA	MM	CM	33.0	36.70	40.60	1	53.3	4.16	1
SMF36A	SMF36CA	MP	CP	36.0	40.00	44.20	1	58.1	3.83	1
SMF40A	SMF40CA	MR	CR	40.0	44.40	49.10	1	64.5	3.49	1
SMF43A	SMF43CA	MT	CT	43.0	47.80	52.80	1	69.4	3.26	1
SMF45A	SMF45CA	MV	CV	45.0	50.00	55.30	1	72.7	3.04	1
SMF48A	SMF48CA	MX	CX	48.0	53.30	58.90	1	77.4	2.93	1
SMF51A	SMF51CA	MZ	CZ	51.0	56.70	62.70	1	82.4	2.70	1
SMF54A	SMF54CA	NE	DE	54.0	60.00	66.30	1	87.1	2.59	1
SMF58A	SMF58CA	NG	DG	58.0	64.40	71.20	1	93.6	2.36	1
SMF60A	SMF60CA	NK	DK	60.0	66.70	73.70	1	96.8	2.25	1
SMF64A	SMF64CA	NM	DM	64.0	71.10	78.60	1	103.0	2.14	1
SMF70A	SMF70CA	NP	DP	70.0	77.80	86.00	1	113.0	1.91	1
SMF75A	SMF75CA	NR	DR	75.0	83.30	92.10	1	121.0	1.80	1
SMF78A	SMF78CA	NT	DT	78.0	86.70	95.80	1	126.0	1.69	1
SMF85A	SMF85CA	NV	DV	85.0	94.4	104.0	1	137.0	1.58	1
SMF90A	SMF90CA	NX	DX	90.0	100.0	111.0	1	146.0	1.46	1
SMF100A	SMF100CA	NZ	DZ	100.0	111.0	123.0	1	162.0	1.35	1
SMF110A	SMF110CA	PE	EE	110.0	122.0	135.0	1	177.0	1.24	1
SMF120A	SMF120CA	PG	EG	120.0	133.0	147.0	1	193.0	1.13	1
SMF130A	SMF130CA	PK	EK	130.0	144.0	159.0	1	209.0	1.01	1
SMF150A	SMF150CA	PM	EM	150.0	167.0	185.0	1	243.0	0.90	1
SMF160A	SMF160CA	PP	EP	160.0	178.0	197.0	1	259.0	0.79	1
SMF170A	SMF170CA	PR	ER	170.0	189.0	209.0	1	275.0	0.79	1
SMF180A	SMF180CA	PT	ET	180.0	201.0	222.0	1	292.0	0.79	1
SMF190A	SMF190CA	PV	EV	190.0	209.0	243.0	1	308.0	0.68	1
SMF200A	SMF200CA	PX	EX	200.0	224.0	247.0	1	324.0	0.68	1
SMF210A	SMF210CA	PZ	EZ	210.0	231.0	268.0	1	340.0	0.68	1
SMF220A	SMF220CA	QE	FE	220.0	246.0	272.0	1	356.0	0.56	1
SMF250A	SMF250CA	QG	FG	250.0	279.0	309.0	1	405.0	0.56	1
SMF300A		QK		300.0	335.0	371.0	1	486.0	0.45	1
SMF350A		QM		350.0	391.0	432.0	1	567.0	0.34	1
SMF400A		QP		400.0	447.0	494.0	1	648.0	0.34	1
SMF440A		QR		440.0	492.0	543.0	1	713.0	0.34	1

Ratings and Characteristics Curves (TA=25°C unless otherwise noted)

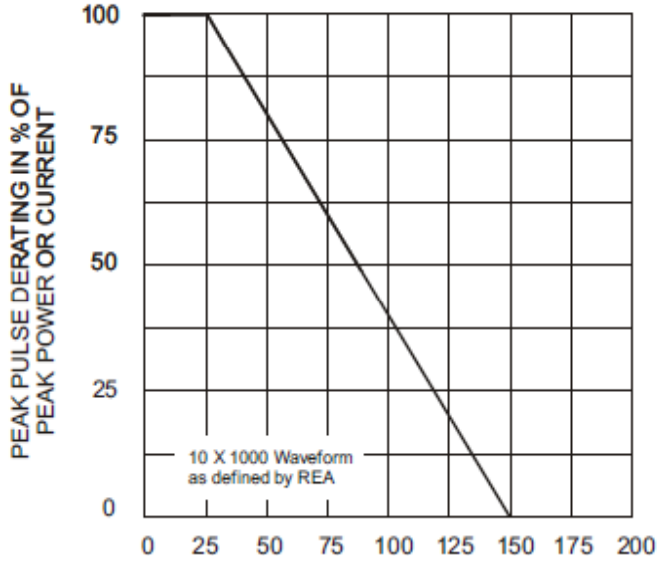

Fig. 1 - Pulse Derating Curve

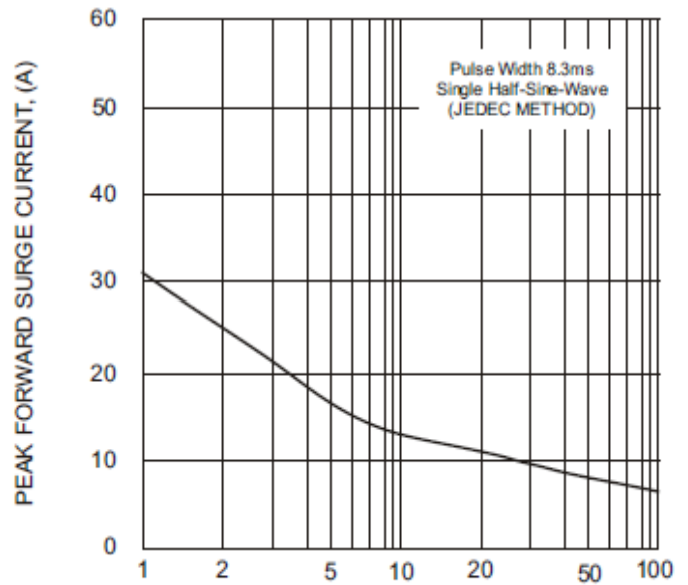

Fig. 2 - Maximum Non-Repetitive Surge Current

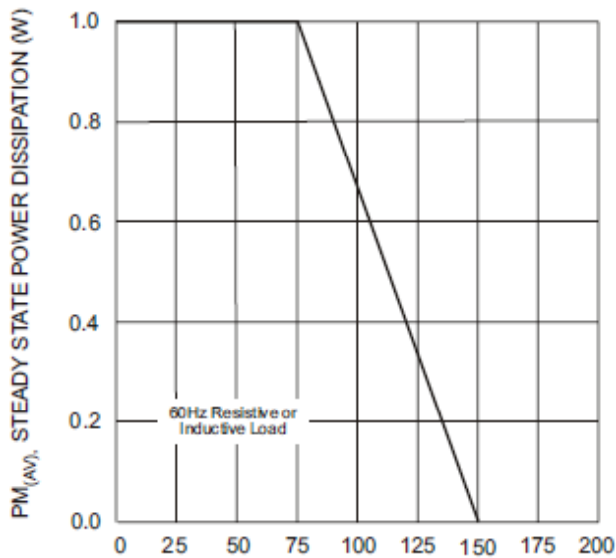

Fig. 3 - Steady State Power Derating Curve

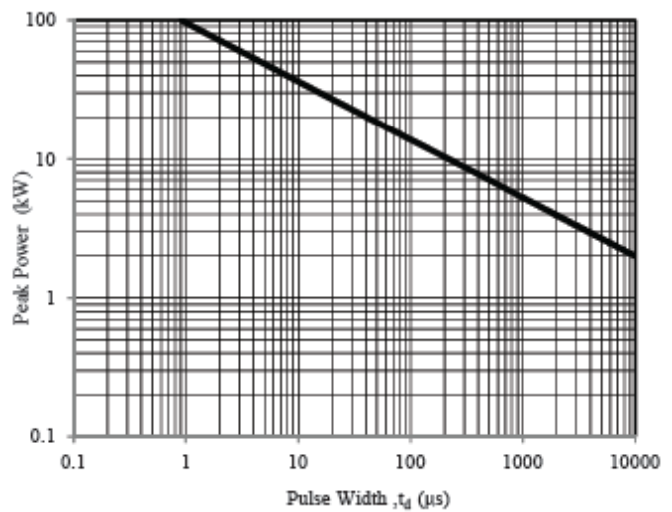

Fig. 4 - Peak Pulse Power Rating Curve

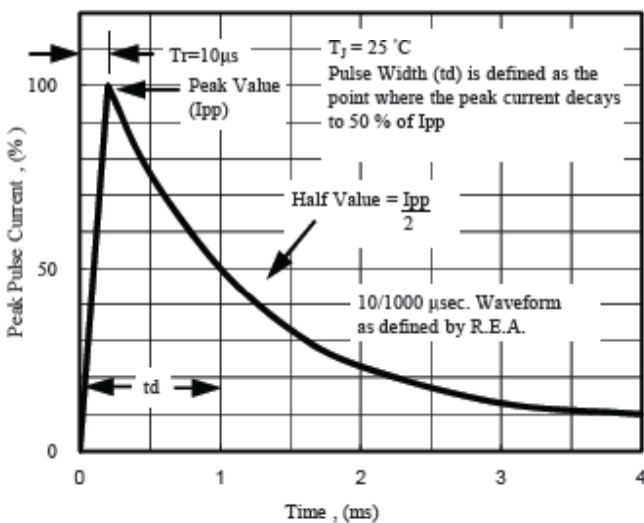

Fig. 5 - Pulse Waveform

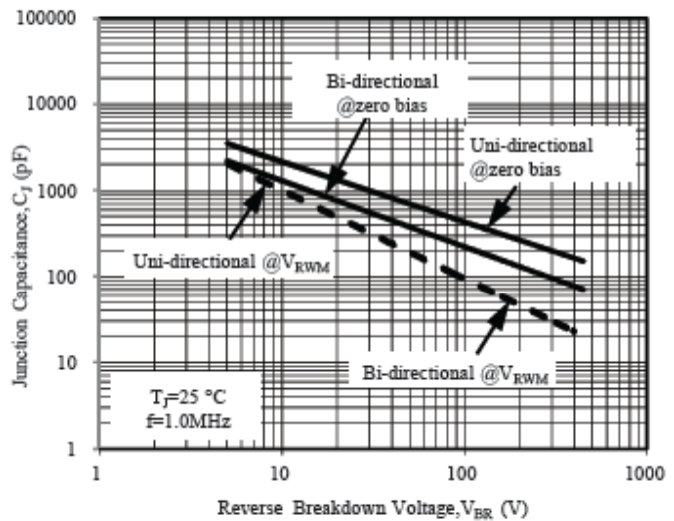
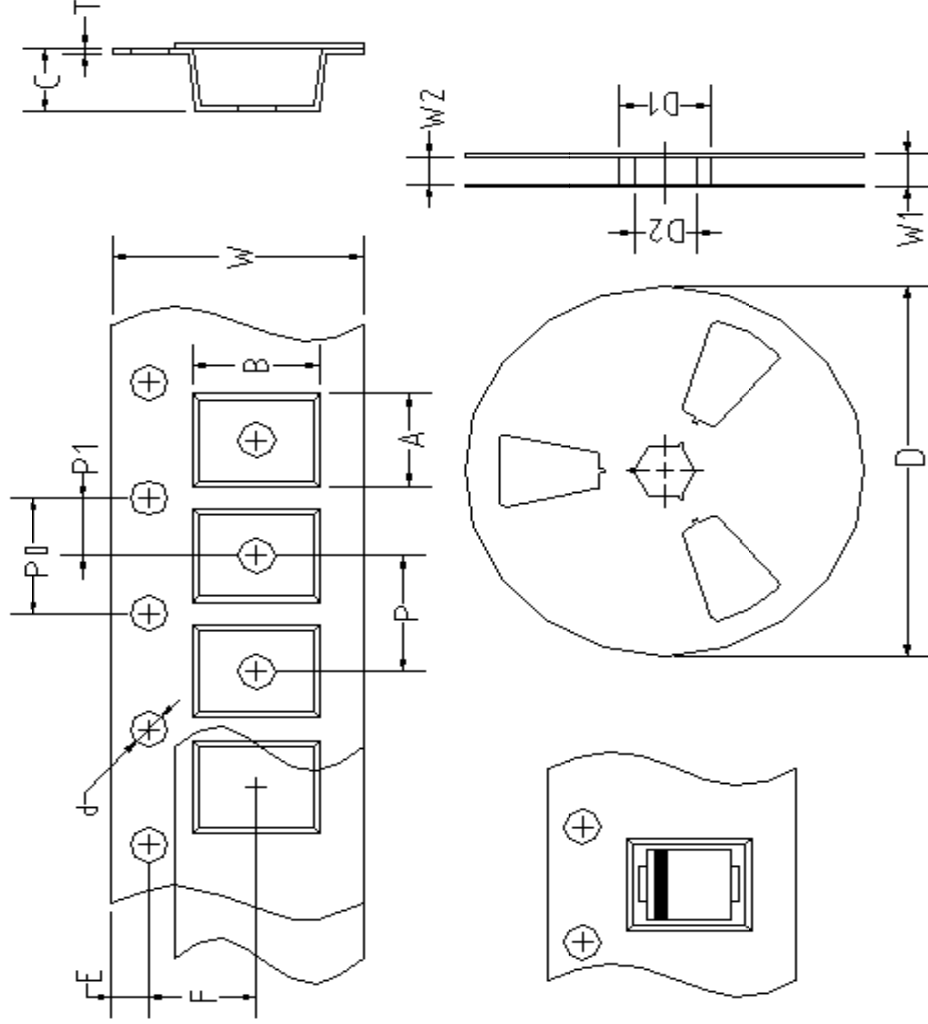

Fig. 6 - Typical Junction Capacitance

SOD123FL产品包装规范



REF	mm	inch
A	2.05±0.10	0.080±0.003
B	3.85±0.10	0.151±0.003
C	1.45±0.10	0.057±0.003
d	1.55±0.10	0.061±0.003
D	177.8±1.0	6.999±0.039
D1	20±1.0	0.787±0.039
D2	13.0±1.0	0.511±0.039
E	1.75±0.10	0.068±0.003
F	3.50±0.05	0.137±0.002
P	4.00±0.10	0.157±0.003
P0	4.00±0.10	0.157±0.003
P1	2.00±0.10	0.078±0.003
T	0.20±0.10	0.007±0.003
W	8.00±0.15	0.314±0.006
W1	16.2±1.5	0.637±0.006
W2	13.2±1.0	0.519±0.039

OUTLINE	REEL (PCS)	PER CARTON (PCS)	REEL DIAMETERS (mm)	CARTON SIZE(mm)		
				L	W	H
TAPING	3,000	252,000	177.8	385	275	385

X-ON Electronics

Largest Supplier of Electrical and Electronic Components

Click to view similar products for [ESD Suppressors / TVS Diodes](#) category:

Click to view products by [ZHIDE](#) manufacturer:

Other Similar products are found below :

[60KS200C](#) [D18V0L1B2LP-7B](#) [D5V0F4U5P5-7](#) [DESD5V0U1BB-7](#) [NTE4902](#) [P4KE27CA](#) [P6KE11CA](#) [P6KE39CA-TP](#) [P6KE8.2A](#)
[SA110CA](#) [SA60CA](#) [SA64CA](#) [SMBJ12CATR](#) [SMBJ33CATR](#) [SMBJ8.0A](#) [ESD101-B1-02ELS E6327](#) [ESD105-B1-02EL E6327](#) [ESD112-B1-02EL E6327](#) [ESD119B1W01005E6327XTSA1](#) [ESD5V0L1B02VH6327XTSA1](#) [ESD7451N2T5G](#) [19180-510](#) [CPDT-5V0USP-HF](#)
[3.0SMCJ33CA-F](#) [3.0SMCJ36A-F](#) [HSPC16701B02TP](#) [D3V3Q1B2DLP3-7](#) [D55V0M1B2WS-7](#) [DESD5V0U1BL-7B](#) [DRTR5V0U4SL-7](#)
[SCM1293A-04SO](#) [ESD200-B1-CSP0201 E6327](#) [SM12-7](#) [SMF8.0A-TP](#) [SMLJ45CA-TP](#) [SMQA1000T1G](#) [CEN955 W/DATA](#) [82350120560](#)
[VESD12A1A-HD1-GS08](#) [CPDUR5V0R-HF](#) [CPDQC5V0U-HF](#) [CPDQC5V0USP-HF](#) [CPDQC5V0-HF](#) [IP4042CX5/LF,135](#) [D1213A-01LP4-7B](#) [D1213A-02WL-7](#) [1SMB33CAT3G-XYZ](#) [MMAD1108/TR13](#) [5KP100A](#) [5KP15A](#)