

RoHS

0.10
0.05

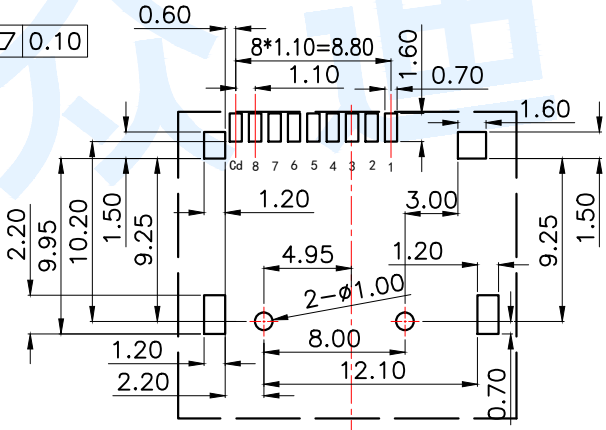
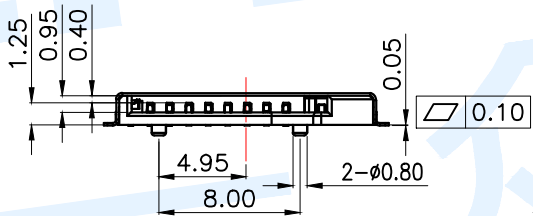
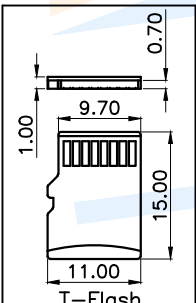
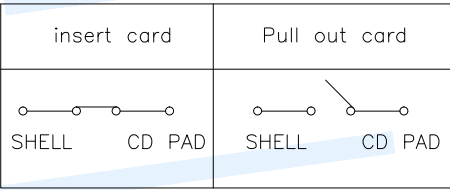
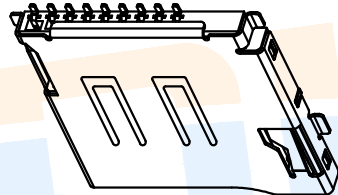
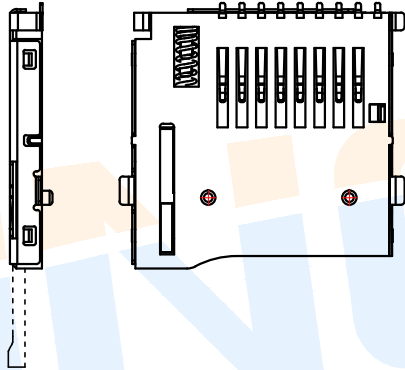
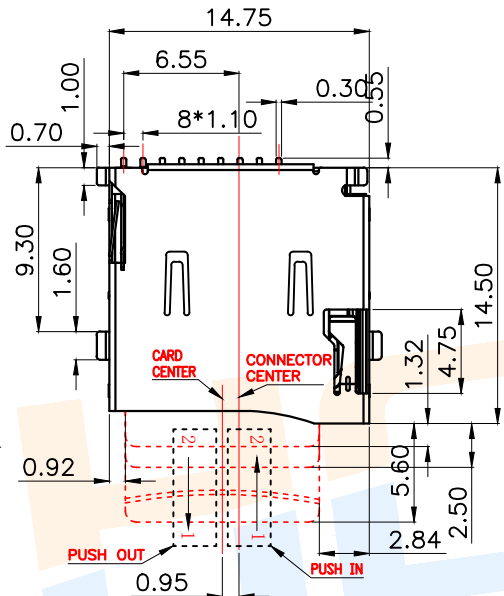
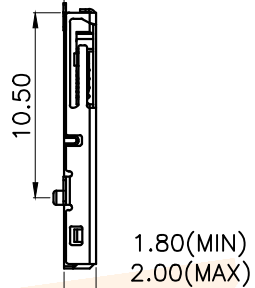

PIN NO.	NAME	TYPE	DESCRIPTION
1	DAT2	I/O/PP	DATE LINE(BIT2)
2	CD/DAT3	I/O/PP	CARD DETECT DATE LIN(BIT3)
3	CMD	PP	COMMAND RESPONSE
4	VDD	S	SUPPLY VOLTAGE
5	CLX	I	CLOCK
6	VSS	S	SUPPLY VOLTAGE GROUND
7	DAT0	I/O/PP	DATE LINE(BIT0)
8	DAT1	I/O/PP	DATE LINE(BIT1)
9	CD	CD	CD

- Specifications/ 技术规格:
- 1.Current rating/ 额定电流: 0.5A
 - 2.Voltage rating/ 额定电压: 100V DC
 - 3.Insulation Resistance/ 绝缘电阻: 100MΩ Min
 - 4.Dielectric Withstanding/ 耐电压: 500V AC/minute
 - 5.Contact Resistance/ 接触电阻: 40mΩ Max
 - 6.Durability/ 耐久性: 5,000 Insertions
 - 7.Operating Temperature/ 工作温度: -40°C to +85°C

①	Spring		1	SUS	Nature
②	Terminal		9	Phosphor bronze	Sn Plated
③	Cover		1	SUS	Ni Plated
④	Base		1	LCP	Black
NO.	Name	Number	Qty	Materil	Remarks

ZHONGDI® Zhongdi Electronic Technology Co., Ltd

design	date	name	TF CARD CONNECTOR
Review	date	model	TF-002A-P
Approved	date		

modify	Review	Approved	Tolerance not specified	Proportion	1:1	unit	mm	gape number	A4
--------	--------	----------	-------------------------	------------	-----	------	----	-------------	----

X-ON Electronics

Largest Supplier of Electrical and Electronic Components

Click to view similar products for [Memory Card Connectors](#) category:

Click to view products by [Zhongdi](#) manufacturer:

Other Similar products are found below :

[6407-249V-25273P](#) [6407-249V-25343P](#) [6426-201-21343](#) [69.920.0553.0](#) [MCR60A-98D-2.54DSA\(70\)](#) [809180410000000](#) [DM3AT-SF-PEJM5\(41\)](#) [IC11S-BUR-PNEJL\(71\)](#) [C70210M0083692](#) [252-0144-000](#) [2041353-2](#) [308-DS1P0811-192](#) [HM2P09PDR360N9LF](#) [10014744-011TLF](#) [11327-001](#) [11327-002](#) [NX1-32T-KT3K\(05\)](#) [95622-003LF](#) [84648-056HLF](#) [CCM03-3109 B LFT](#) [MS3116J10-6PW](#) [2309923-1](#) [61126-050CAHLF](#) [GTFP08432B1HR](#) [G85D1160022HHR](#) [SCE2MSDB76A121SN](#) [SCE2MSDZN76A121SN](#) [10014744-011ALF](#) [10014744-011LF](#) [10057542-1211FLF](#) [10067972-000LF](#) [10067972-050LF](#) [10122302-20110LF](#) [G85D1162022HHR](#) [TF-05A](#) [M6014-12](#) [XKNANO-1412](#) [SMN-304-ARP6](#) [MIS11-S1F1-2000-A](#) [SMN-308-ARSP7](#) [SMN-308-ACSP7](#) [K-DYX-008](#) [K-DYX-004](#) [HYCW126-TF18-150B](#) [C7024-03](#) [SMO-1030](#) [MCS-110-KT](#) [SIM-217](#) [SNO-1355-KT](#) [SMO-1025-P10](#)