

RoHS

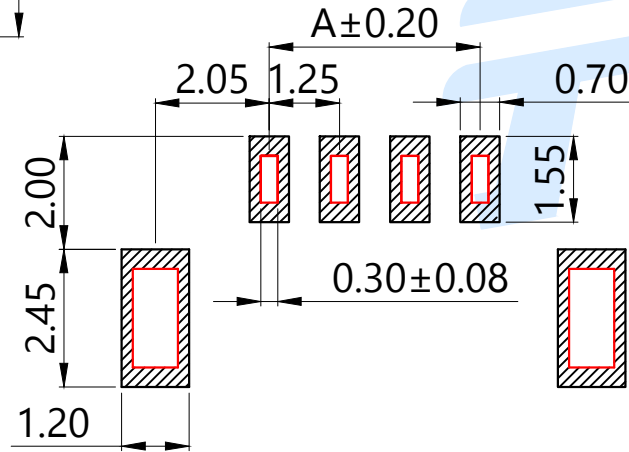
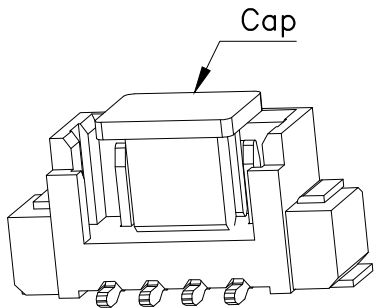
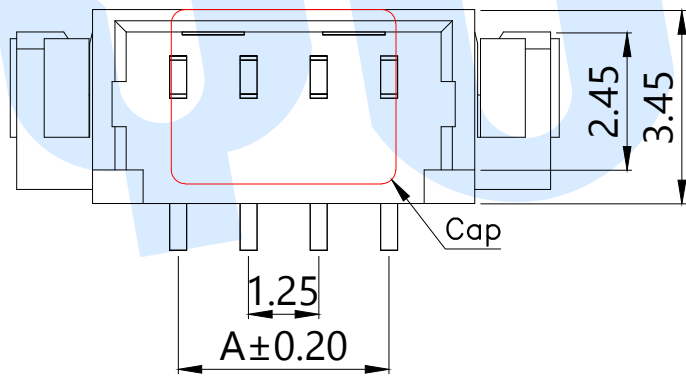
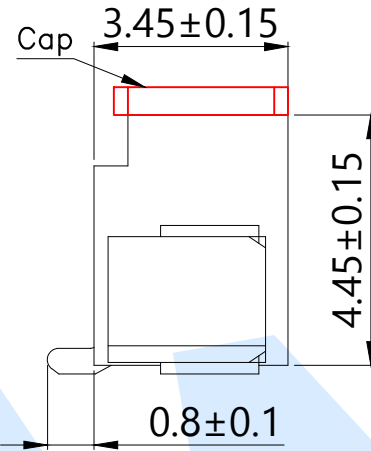
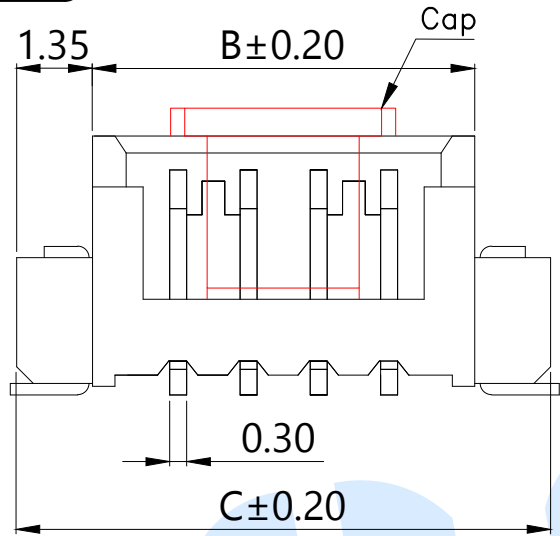

适用线路板 (PCB LAYOUT)

Model No.	Pin	A	B	C
WAFER-MX1.25-2PLT-W1	2	1.25	4.30	7.00
WAFER-MX1.25-3PLT-W1	3	2.50	5.55	8.25
WAFER-MX1.25-4PLT-W1	4	3.75	6.80	9.50
WAFER-MX1.25-5PLT-W1	5	5.00	8.05	10.75
WAFER-MX1.25-6PLT-W1	6	6.25	9.30	12.00
WAFER-MX1.25-7PLT-W1	7	7.50	10.55	13.25
WAFER-MX1.25-8PLT-W1	8	8.75	11.80	14.50
WAFER-MX1.25-9PLT-W1	9	10.00	13.05	15.75
WAFER-MX1.25-10PLT-W1	10	11.25	14.30	17.00
WAFER-MX1.25-11PLT-W1	11	12.50	15.55	18.25
WAFER-MX1.25-12PLT-W1	12	13.75	16.80	19.50
WAFER-MX1.25-13PLT-W1	13	15.00	18.05	20.75
WAFER-MX1.25-14PLT-W1	14	16.25	19.30	22.00
WAFER-MX1.25-15PLT-W1	15	17.50	20.55	23.25
WAFER-MX1.25-16PLT-W1	16	18.75	21.80	24.50
WAFER-MX1.25-17PLT-W1	17	20.00	23.05	25.75
WAFER-MX1.25-18PLT-W1	18	21.25	24.30	27.00
WAFER-MX1.25-19PLT-W1	19	22.50	25.55	28.25
WAFER-MX1.25-20PLT-W1	20	23.75	26.80	29.50

WAFER-MX1.25-□□PLT-W1 (-P=盘装, 非盘装不启用)

Specifications/技术规格:

- 1.Poles/线数: 2~20P
- 2.Wire range/适用线规: AGW 32#~28#
- 3.Applicable PC board thickness/适用PC板厚度: 0.6~1.2mm
- 4.Current rating/额定电流: 1.0A
- 5.Voltage rating/额定电压: 125V DC/AC
- 6.Insulation Resistance/绝缘电阻: 100MΩ Min
- 7.Dielectric Withstanding/ 耐压: 500V AC/minute
- 8.Contact Resistance/ 接触电阻: 20mΩ Max
- 9.Operating Temperature/ 工作温度: -25°C to +85°C

Ⓒ	Soldering lug		1	Brass	Plating Sn
Ⓑ	Terminal			Brass	Plating Sn
Ⓐ	Housing		1	LCP	Off White
NO.	Name	Number	Qty	Materil	Remarks

YUANDI® Yuandi Electronics Co, Ltd
元典

design	date	name	WAFER CONNECTOR
Review	date	model	WAFER-MX1.25-□□PLT-W1
Approved	date		

Drawing number: Proportion 1:1 unit mm gage number A4

modify Review Approved Tolerance not specified

X-ON Electronics

Largest Supplier of Electrical and Electronic Components

Click to view similar products for [Headers & Wire Housings](#) category:

Click to view products by [Zhongdi](#) manufacturer:

Other Similar products are found below :

[0015917161](#) [0022155065](#) [57102-F02-18ULF](#) [58102-G61-06LF](#) [582553-1](#) [01.001.5753.1](#) [0050291907](#) [02.125.8002.8](#) [609-3404](#) [61062-3](#)
[CSU011177004](#) [622-0430](#) [622-3653LF](#) [63453-116](#) [636-1030](#) [636-1427](#) [636-3427](#) [636-4007](#) [641938-9](#) [65495-038](#) [65692-001LF](#) [65781-018](#)
[65781-047](#) [65817-010LF](#) [65817-015LF](#) [67095-007LF](#) [67601157](#) [68631-112](#) [699319-000](#) [70.362.1628.0](#) [70-4210](#) [70-4226B](#) [70-4853B](#) [707-](#)
[5028](#) [71.350.2428.0](#) [733-134](#) [733-162](#) [760-3052](#) [MHR-64-VUAL](#) [80.063.4001.1](#) [800-90-001-10-001000](#) [801-43-002-10-013000](#)
[801-43-006-10-002000](#) [803-43-024-10-001000](#) [803-93-012-10-001000](#) [8-1437020-4](#) [819-22-004-30-001101](#) [820-22-006-30-001101](#)
[820-22-008-30-001101](#) [821-22-002-10-001101](#)