

RoHS

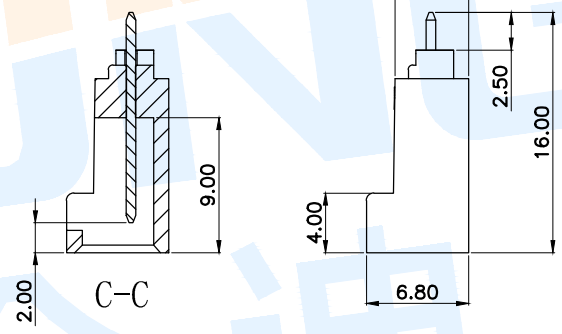

| Model No. | Pin | A | B | C |
|-----------------------|-----|-------|-------|-------|
| WAFER-TJC8-2.54-2PZZ | 2 | 2.54 | 7.50 | 5.60 |
| WAFER-TJC8-2.54-4PZZ | 4 | 10.99 | 15.95 | 14.05 |
| WAFER-TJC8-2.54-6PZZ | 6 | 19.44 | 24.40 | 22.50 |
| WAFER-TJC8-2.54-8PZZ | 8 | 27.89 | 32.85 | 30.95 |
| WAFER-TJC8-2.54-10PZZ | 10 | 36.34 | 41.30 | 39.40 |
| WAFER-TJC8-2.54-12PZZ | 12 | 44.79 | 49.75 | 47.85 |

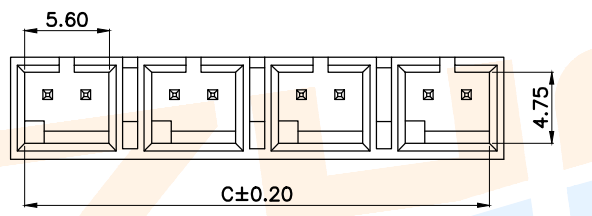
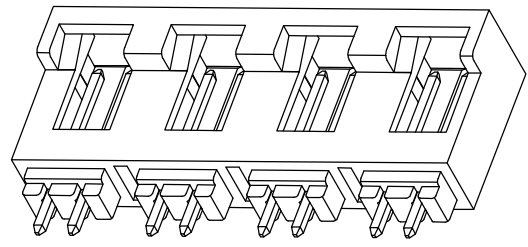
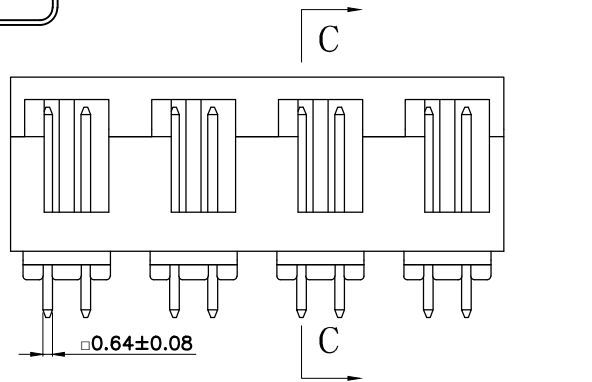
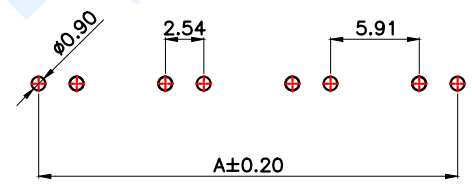
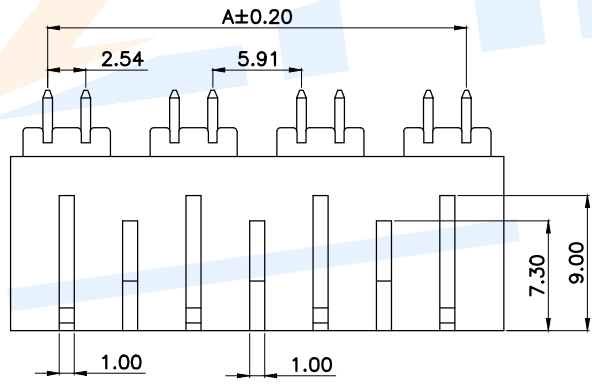

适用线路板 (PCB LAYOUT)

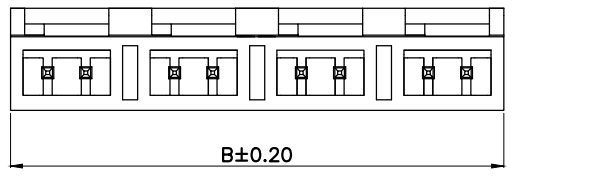

Specifications/技术规格:

- 1.Poles/线数: 2P、4P、6P、8P、10P、12P
- 2.Wire range/适用线规: AGW 26#~22#
- 3.Applicable PC board thickness/适用PC板厚度: 1.6mm
- 4.Current rating/额定电流: 3.0A
- 5.Voltage rating/额定电压: 250V DC/AC
- 6.Insulation Resistance/绝缘电阻: 1000MΩ Min
- 7.Dielectric Withstanding/耐电压: 1500V AC/minute
- 8.Contact Resistance/接触电阻: 20mΩ Max
- 9.Operating Temperature/工作温度: -25℃ to +85℃

| NO. | Name | Number | Qty | Materil | Remarks |
|-----|----------|--------|-----|---------|------------|
| Ⓑ | Terminal | | | Brass | Plating Sn |
| Ⓐ | Housing | | 1 | PA66 | Black |

ZHONGDI® Zhongdi Electronic Technology Co., Ltd

| | | | |
|----------|------|-------|-----------------------|
| design | date | name | WAFER CONNECTOR |
| Review | date | model | WAFER-TJC8-2.54-□□PZZ |
| Approved | date | | |

Drawing number: Proportion 1:1 unit mm gage number A4

modify Review Approved Tolerance not specified

X-ON Electronics

Largest Supplier of Electrical and Electronic Components

Click to view similar products for [Headers & Wire Housings](#) category:

Click to view products by [Zhongdi](#) manufacturer:

Other Similar products are found below :

[0015917161](#) [0022155065](#) [57102-F02-18ULF](#) [58102-G61-06LF](#) [582553-1](#) [01.001.5753.1](#) [0050291907](#) [02.125.8002.8](#) [609-3404](#) [61062-3](#)
[CSU011177004](#) [622-0430](#) [622-3653LF](#) [63453-116](#) [636-1030](#) [636-1427](#) [636-3427](#) [636-4007](#) [641938-9](#) [65495-038](#) [65692-001LF](#) [65781-018](#)
[65781-047](#) [65817-010LF](#) [65817-015LF](#) [67095-007LF](#) [67601157](#) [68631-112](#) [699319-000](#) [70.362.1628.0](#) [70-4210](#) [70-4226B](#) [70-4853B](#) [707-](#)
[5028](#) [71.350.2428.0](#) [733-134](#) [733-162](#) [760-3052](#) [MHR-64-VUAL](#) [80.063.4001.1](#) [800-90-001-10-001000](#) [801-43-002-10-013000](#)
[801-43-006-10-002000](#) [803-43-024-10-001000](#) [803-93-012-10-001000](#) [8-1437020-4](#) [819-22-004-30-001101](#) [820-22-006-30-001101](#)
[820-22-008-30-001101](#) [821-22-002-10-001101](#)