

MARK	PLACES	ZONE	ECN	DATE

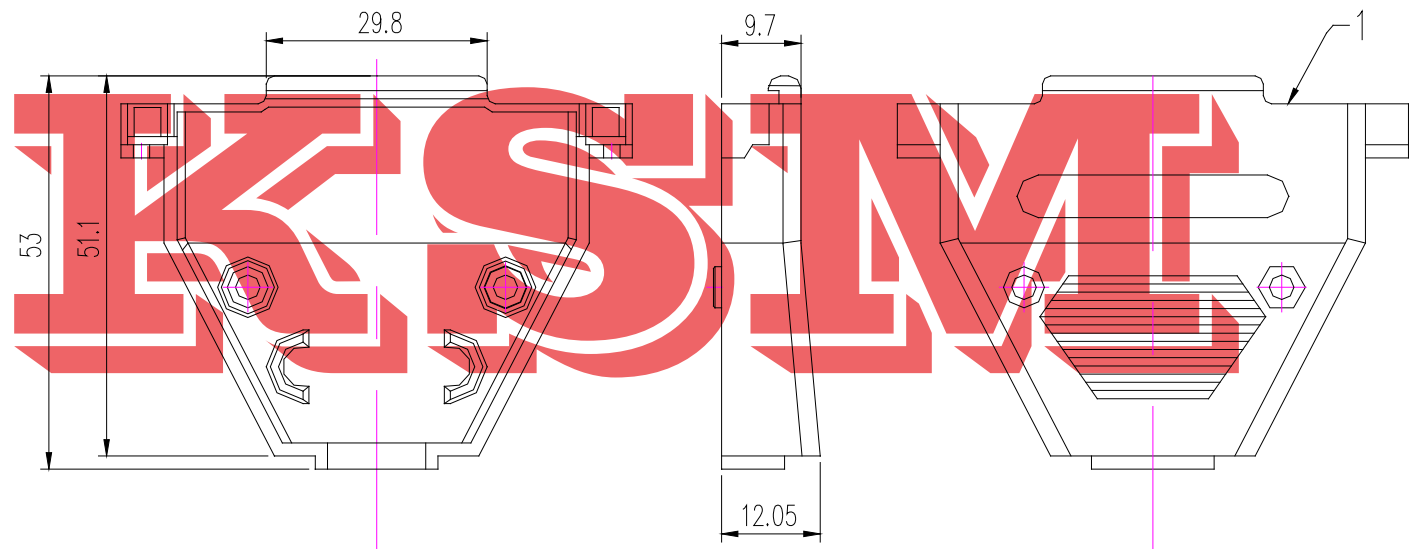

BOM LIST			
ITEM	PART NAME	Q'ty	NOTES
1	PLASTIC HOOD	2	ABS
2	2.1 LONG BOLT	2	#4-40
	2.2 SHORT BOLT	2	#4-40
3	NUT	2	M3
4	LONG SCREW	2	M3
5	SMALL WASHER	2	
6	SHORT SCREW	2	M3
7	7.1 METAL WASHER	2	M3
	7.2 PLASTIC-1 WASHER	2	ABS
	7.3 PLASTIC-2 WASHER	2	ABS

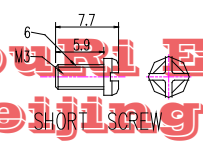
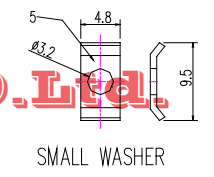
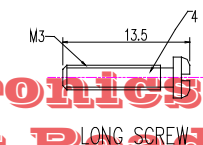
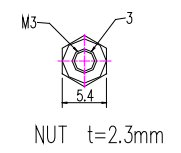
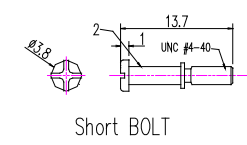
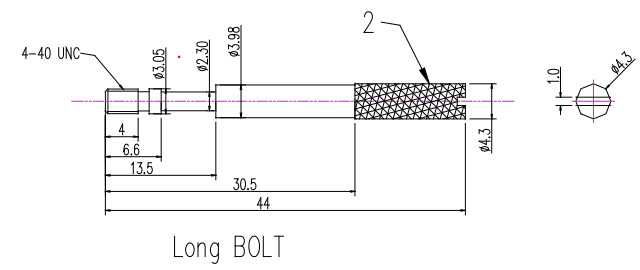
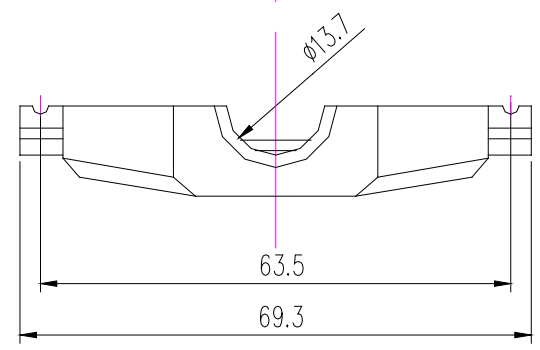

Shanghai ZhouRi Electronics CO., Ltd.

Add: No. 668 Beijing East Road

Tel: 86-21-51571121 53085565

Fax: 86-21-51571120

Http: www.ksmchina.com

E-mail: zhouri11@163.com

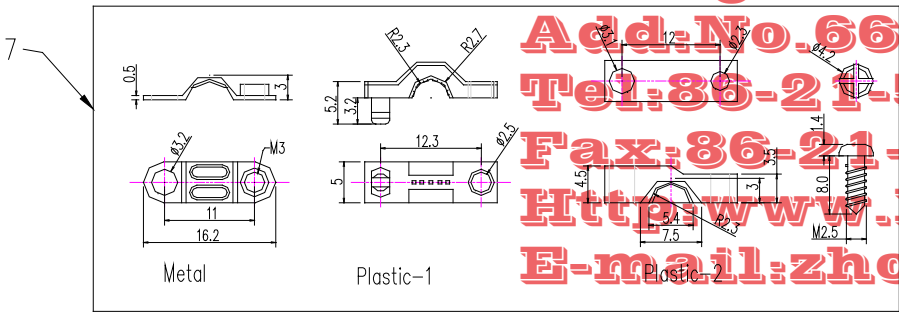

DIMENSION	TOLERANCE	
	DECIMAL	ANGLE
X.X	+0.2	+0.5°
X.XX	+0.1	±0°
X.XXX	+0.05	

37 D-SUB	
MODEL NO.	DB Hood
DWG. NO.	ZR-Hood-004
DESIGNED	Item NO.
CHECKED	REV. A/0
APPROVED	SCALE

上海洲日电子有限公司	
Shanghai ZhuoRi Electronics CO.,LTD.	
MATERIAL	FINISH
COLOR	QUANTITY
UNIT	mm
SIZE	A4
SHEET	PAGES

THE THIRD ANGLE PROJECTION	1:1	mm	A4
----------------------------	-----	----	----

X-ON Electronics

Largest Supplier of Electrical and Electronic Components

Click to view similar products for [D-Sub Backshells](#) category:

Click to view products by [ZHOURI](#) manufacturer:

Other Similar products are found below :

[600X54009X](#) [600X56025X](#) [M85049/6-38N](#) [M85049/86-12N03](#) [70.350.0636.4](#) [72.350.1035.2](#) [73.359.4035.3](#) [747534-2](#) [829472-1](#) [PCS-E20W](#) [970-015-040R011](#) [971-009-040R011](#) [DD-C4-J13-S1](#) [DPH-B-003](#) [165X02659X](#) [165X10899X](#) [165X11689X](#) [165X13169X](#) [L171373](#)
[971-037-040R011](#) [300X11139X](#) [165X00809X](#) [165X11629XE](#) [165X17189X](#) [165X17449X](#) [300X10179X](#) [500-047M37H](#) [500T010J21H08](#)
[557-083B1](#) [557B316M535TB8](#) [557E316M536TB6](#) [557S283NF1A05](#) [557T071NF131SB](#) [557T113M232B](#) [400FS001M2410F2](#) [DA-C8-J10-F1-1R](#) [DB-C2-J9R](#) [DB-C8-J10-F5-1R](#) [419-2080-502](#) [DC-C8-J13-B1-1R](#) [DMHE001](#) [500-016NF09EN](#) [500-017M51FN](#) [500T010M15E08](#)
[500T010M15H06](#) [500T010NF15B08](#) [500T010NF15H08](#) [500T012M21E](#) [507-146M31EC](#) [057-3006-011](#)